



— SEIT 1911 —



Hängeleuchten

Eine klassische Leuchte mit Reflektor in abgeflachter Kegelform. Aus traditionell gefertigten Guss- und Drückteilen sowie einzelnen Porzellanelementen. Sie zeichnet sich aus durch ihr zeitloses Design und ihre besonders breit gefächerten Einsatzmöglichkeiten.



Sievering

<p>Abgebildete Leuchte: Reflektor-Ø 400 mm, aus veredeltem Stahlblech, außen Tiefschwarz (S/S), innen Reinweiß, Alu-Gussaufhängung mit vernickelter Kette (AGK), schwarzes Textil-Kabel (TS) 1,5 m lang, mit Metall-Baldachin Halbkugel Ø 80 mm</p> <p>Mit hochwertiger Porzellanfassung E27, für Glühlampen bis max. 100 Watt</p>	<p>Reflektor-Ø / Leuchtenhöhe</p> <table border="0"> <tr><td>■ 250 mm</td><td>/ 190 mm</td></tr> <tr><td>■ 300 mm</td><td>/ 210 mm</td></tr> <tr><td>■ 350 mm</td><td>/ 240 mm</td></tr> <tr><td>■ 400 mm</td><td>/ 280 mm</td></tr> <tr><td>■ 450 mm</td><td>/ 330 mm</td></tr> <tr><td>■ 500 mm</td><td>/ 350 mm</td></tr> <tr><td>■ 600 mm</td><td>/ 365 mm</td></tr> </table> <p>■ Haupttypen</p> <p>Extras</p> <ul style="list-style-type: none"> • Schutzkorb aus Stahldraht, verzinkt, Ø 300 mm, Ø 400 mm, Ø 500 mm • E40 für Glühlampen bis 1000 Watt bei Ø 500 mm, Ø 600 mm mit Kabel-Box <p>Sonderausführungen auf Anfrage</p>	■ 250 mm	/ 190 mm	■ 300 mm	/ 210 mm	■ 350 mm	/ 240 mm	■ 400 mm	/ 280 mm	■ 450 mm	/ 330 mm	■ 500 mm	/ 350 mm	■ 600 mm	/ 365 mm	<p>Lieferung bei allen Aufhängungen komplett mit klassischem Baldachin</p>	<table border="0"> <tr> <td> E27</td> <td> E27</td> </tr> <tr> <td> E40</td> <td> E40</td> </tr> <tr> <td> CE</td> <td>230 V 50 Hz</td> </tr> <tr> <td> IP 20</td> <td> IP 20</td> </tr> <tr> <td colspan="2"> elektrische Bauteile geprüft</td> </tr> </table>	 E27	 E27	 E40	 E40	 CE	230 V 50 Hz	 IP 20	 IP 20	 elektrische Bauteile geprüft	
■ 250 mm	/ 190 mm																										
■ 300 mm	/ 210 mm																										
■ 350 mm	/ 240 mm																										
■ 400 mm	/ 280 mm																										
■ 450 mm	/ 330 mm																										
■ 500 mm	/ 350 mm																										
■ 600 mm	/ 365 mm																										
 E27	 E27																										
 E40	 E40																										
 CE	230 V 50 Hz																										
 IP 20	 IP 20																										
 elektrische Bauteile geprüft																											

Materialien - Oberflächen

Stahlblech beschichtet / lackiert

Tiefschwarz S/S

Reinweiß, RAL 9010 S/W

Sonderlackierung in RAL-Farbtönen möglich

Aluminium natur

ohne Lackierung A/R

Klarlack matt A/M

Klarlack glänzend A/G

Stahlblech natur

Klarlack matt S/M

Klarlack glänzend S/G

Kupfer natur

ohne Lackierung K/R

Klarlack matt K/M

Klarlack glänzend K/G

Aufhängungen: Kabel/Kupferkette

Aufhängungen



Kabel-Aufhängung K/...



Alu-Gussaufhängung mit vernickelter Kette AGK/...



Alu-Gussaufhängung mit Stahlschlüssel AGS/...



Alu-Kabel-Box mit vernickelter Kette ABK/...



Alu-Kabel-Box mit Seilaufhänger ABS

Kabelvarianten zu den Aufhängungen



PVC-Kabel schwarz.../PS



PVC-Kabel weiß.../PW



Textil-Kabel schwarz.../TS



Textil-Kabel weiß.../TW





















Textil-Kabel schwarz-weiß.../TSW

Eine klassische Leuchte mit zwei Reflektoren in abgeflachter Kegelform. Aus traditionell gefertigten Guss- und Drückteilen sowie einzelnen Porzellanelementen. Durch die hochwertigen Zahngelenke in Kombination mit Pendelrohren ist ihr Neigungswinkel flexibel. Sie zeichnet sich aus durch ihr zeitloses Design und ihre besonders breit gefächerten Einsatzmöglichkeiten.



Sievering II Gelenk

<p>Abgebildete Leuchte: Reflektoren-Ø 400 mm, aus veredeltem Stahlblech, außen Tiefschwarz (S/S), innen Reinweiß, je 500 mm Pendelrohrabhängung Ø 16 mm, Zahngelenke Messing vernickelt (Z/MN) am Reflektor (aR) und an Alu-Gussrosette (aG) in Langform 175 x 55 mm</p> <p>Mit hochwertiger Porzellanfassung E27, für Glühlampen bis max. 100 Watt</p>	<p>Reflektor-Ø / Reflektorhöhe</p> <table border="0"> <tr><td>250 mm</td><td>/ 190 mm</td></tr> <tr><td>300 mm</td><td>/ 210 mm</td></tr> <tr><td>350 mm</td><td>/ 240 mm</td></tr> <tr><td>400 mm</td><td>/ 280 mm</td></tr> <tr><td>450 mm</td><td>/ 330 mm</td></tr> <tr><td>500 mm</td><td>/ 350 mm</td></tr> <tr><td>600 mm</td><td>/ 365 mm</td></tr> </table> <p>■ Haupttypen</p> <p>Pendelrohrlänge (ohne Leuchte)</p> <table border="0"> <tr><td>250 mm</td><td>750 mm</td></tr> <tr><td>500 mm</td><td>1000 mm</td></tr> </table> <p>Extras</p> <ul style="list-style-type: none"> • Sonderlängen der Pendelrohre auf Wunsch • Beliebig mit Zahngelenken kombinierbar <p>Sonderausführungen auf Anfrage</p>	250 mm	/ 190 mm	300 mm	/ 210 mm	350 mm	/ 240 mm	400 mm	/ 280 mm	450 mm	/ 330 mm	500 mm	/ 350 mm	600 mm	/ 365 mm	250 mm	750 mm	500 mm	1000 mm	<p>Mit Alu-Gussrosette in Langform</p> 	<table border="0"> <tr> <td> E27</td> <td> E27</td> </tr> <tr> <td></td> <td>230 V 50 Hz</td> </tr> <tr> <td></td> <td>IP 20</td> </tr> <tr> <td></td> <td> elektrische Bauteile geprüft</td> </tr> </table>	 E27	 E27		230 V 50 Hz		IP 20		 elektrische Bauteile geprüft
250 mm	/ 190 mm																												
300 mm	/ 210 mm																												
350 mm	/ 240 mm																												
400 mm	/ 280 mm																												
450 mm	/ 330 mm																												
500 mm	/ 350 mm																												
600 mm	/ 365 mm																												
250 mm	750 mm																												
500 mm	1000 mm																												
 E27	 E27																												
	230 V 50 Hz																												
	IP 20																												
	 elektrische Bauteile geprüft																												

Materialien - Oberflächen

Stahlblech beschichtet / lackiert



Tiefschwarz
S/S



Reinweiß, RAL 9010
S/W

Sonderlackierung in RAL-Farbtönen möglich

Aluminium natur



ohne Lackierung
A/R



Klarlack matt
A/M



Klarlack glänzend
A/G

Stahlblech natur



Klarlack matt
S/M



Klarlack glänzend
S/G

Kupfer natur



ohne Lackierung
K/R



Klarlack matt
K/M



Gussrosette: Tiefschwarz

Zahngelenk



Messing poliert
Z/MP



Messing vernickelt
Z/MN

Anordnung



am Reflektor .../aR



am Pendelrohr .../aP



an Gussrosette .../aG

Eine geschlossene Leuchte mit Reflektor in abgeflachter Kegelform und Verschluss aus klarem Glas. Aus traditionell gefertigten Guss- und Drückteilen sowie einzelnen Porzellanelementen. Sie zeichnet sich aus durch ihr zeitloses Design und ihre besonders breit gefächerten Einsatzmöglichkeiten. Der Glasverschluss verleiht der Leuchte eine besonders kompakte Optik und schafft ein angenehm diffuses Licht.



Sievering Glas

<p>Abgebildete Leuchte: Reflektor-Ø 315 mm, aus veredeltem Stahlblech, außen Tiefschwarz (S/S), innen Reinweiß, mit Glas, Alu-Gussaufhängung mit vernickelter Kette (AGK), schwarzes PVC-Kabel (PS) 1,5 m lang, komplett mit Metall-Baldachin Halbkugel Ø 80 mm</p> <p>Mit hochwertiger Porzellanfassung E27, für Glühlampen bis max. 100 Watt</p>	<p>Reflektor-Ø / Leuchtenhöhe mit Glas 315 mm / 270 mm 415 mm / 375 mm</p> <p>Glas-Ø 300 mm 400 mm</p> <p>Extras • Schutzkorb aus Stahldraht, verzinkt, Ø 350 mm, Ø 450 mm</p> <p>Sonderausführungen auf Anfrage</p>	<p>Lieferung bei allen Aufhängungen komplett mit klassischem Baldachin</p> 	 E27  E27  230 V 50 Hz  IP 20  elektrische Bauteile geprüft
---	---	---	---

Materialien - Oberflächen

Stahlblech beschichtet / lackiert



Sonderlackierung in RAL-Farbtönen möglich

Aluminium natur

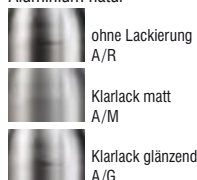

Stahlblech natur



Kupfer natur



Aufhängungen: Kabel/Kupferkette

Aufhängungen



Kabel-Aufhängung K/...

Alu-Gussaufhängung mit vernickelter Kette AGK/...

Alu-Gussaufhängung mit Stahlschlüssel AGS/...

Alu-Kabel-Box mit vernickelter Kette ABK/...

Alu-Kabel-Box mit Seilaufhänger ABS

Kabelvarianten zu den Aufhängungen

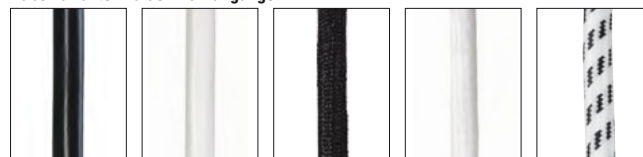

PVC-Kabel schwarz.../PS

PVC-Kabel weiß.../PW

Textil-Kabel schwarz.../TS

Textil-Kabel weiß.../TW

Textil-Kabel schwarz-weiß.../TSW

Eine klassische Leuchte mit Reflektor in abgeflachter Kegelform plus opalemem Schraubglas in Kugelform. Aus traditionell gefertigten Guss- und Drückteilen sowie einzelnen Porzellanelementen. Sie zeichnet sich aus durch ihr zeitloses Design und ist mit eingebautem Gusskopf mit Dichtung und Schraubglas spritzwassergeschützt.



Sievering Kugel

<p>Abgebildete Leuchte: Reflektor-Ø 450 mm, aus veredeltem Stahlblech, außen Tiefschwarz (S/S), innen Reinweiß, opales Kugelglas bis 100 Watt, Alu-Kabel-Box mit vernickelter Kette (ABK), schwarzes PVC-Kabel (PS) 1,5 m lang, mit Metall-Baldachin Halbkugel Ø 80 mm</p> <p>Mit hochwertiger Porzellanfassung E27, für Glühlampen bis max. 60/100 Watt</p>	<p>Reflektor-Ø / -höhe mit Glas 350 mm / 285 mm (max. 60 Watt) 400 mm / 305 mm (max. 60 Watt) 450 mm / 360 mm (max. 100 Watt) 500 mm / 360 mm (max. 100 Watt) 600 mm / 365 mm (max. 100 Watt)</p> <p>Glas-Ø 160 mm (max. 60 Watt) 180 mm (max. 100 Watt)</p> <p>Sonderausführungen auf Anfrage</p>	<p>Lieferung bei allen Aufhängungen komplett mit klassischem Baldachin</p> 	 E27  E27  230 V 50 Hz  IP 54   elektrische Bauteile geprüft
---	--	---	---

Materialien - Oberflächen

Stahlblech beschichtet / lackiert



Tiefschwarz
S/S



Reinweiß, RAL 9010
S/W

Sonderlackierung in RAL-Farbtönen möglich

Aluminium natur



ohne Lackierung
A/R



Klarlack matt
A/M



Klarlack glänzend
A/G

Stahlblech natur



Klarlack matt
S/M



Klarlack glänzend
S/G

Kupfer natur



ohne Lackierung
K/R



Klarlack matt
K/M



Klarlack glänzend
K/G

Aufhängungen: Kabel/Kupferkette

Aufhängungen



Kabel-Aufhängung
K/...



Alu-Gussaufhängung
mit vernickelter Kette
AGK/...



Alu-Gussaufhängung
mit Stahlseil
AGS/...



Alu-Kabel-Box
mit vernickelter Kette
ABK/...



Alu-Kabel-Box
mit Seilaufhänger
ABS

Kabelvarianten zu den Aufhängungen



PVC-Kabel
schwarz.../PS



PVC-Kabel
weiß.../PW



Textil-Kabel
schwarz.../TS



Textil-Kabel
weiß.../TW



Textil-Kabel
schwarz-weiß.../TSW

Eine klassische Leuchte mit Reflektor in abgeflachter Kegelform plus Schraubglas in Zylinderform. Aus traditionell gefertigten Guss- und Drückteilen sowie einzelnen Porzellanelementen. Sie zeichnet sich aus durch ihr zeitloses Design und ist mit eingebautem Gusskopf mit Dichtung und Schraubglas spritzwassergeschützt.



Sievering Zylinder

<p>Abgebildete Leuchte: Reflektor-Ø 450 mm, aus veredeltem Stahlblech, außen Tiefschwarz (S/S), innen Reinweiß, klares Zylinderglas bis 100 Watt, Alu-Kabel-Box mit vernickelter Kette (ABK), schwarzes PVC-Kabel (PS) 1,5 m lang, mit Metall-Baldachin Halbkugel Ø 80 mm</p> <p>Mit hochwertiger Porzellanfassung E27, für Glühlampen bis max. 60/100 Watt</p>	<p>Reflektor-Ø / -höhe mit Glas 350 mm / 285 mm (max. 60 Watt) 400 mm / 305 mm (max. 60 Watt) 450 mm / 360 mm (max. 100 Watt) 500 mm / 360 mm (max. 100 Watt) 600 mm / 365 mm (max. 100 Watt)</p> <p>Glas-Ø 100 mm (max. 60 Watt) 110 mm (max. 100 Watt)</p> <p>Extras • Zylinderglas auch in Matt lieferbar</p> <p>Sonderausführungen auf Anfrage</p>	<p>Lieferung bei allen Aufhängungen komplett mit klassischem Baldachin</p> 	 E27  E27  230 V 50 Hz  IP 54   elektrische Bauteile geprüft
--	---	---	---

Materialien - Oberflächen

Stahlblech beschichtet / lackiert

 Tiefschwarz
S/S

 Reinweiß, RAL 9010
S/W

Sonderlackierung in RAL-Farbtönen möglich

Aluminium natur

 ohne Lackierung
A/R

 Klarlack matt
A/M

 Klarlack glänzend
A/G

Stahlblech natur

 Klarlack matt
S/M

 Klarlack glänzend
S/G

Kupfer natur

 ohne Lackierung
K/R

 Klarlack matt
K/M

 Klarlack glänzend
K/G

Aufhängungen: Kabel/Kupferkette

Aufhängungen



Kabel-Aufhängung
K/...



Alu-Gussaufhängung
mit vernickelter Kette
AGK/...



Alu-Gussaufhängung
mit Stahlseil
AGS/...



Alu-Kabel-Box
mit vernickelter Kette
ABK/...



Alu-Kabel-Box
mit Seilaufhänger
ABS

Kabelvarianten zu den Aufhängungen



PVC-Kabel
schwarz.../PS



PVC-Kabel
weiß.../PW



Textil-Kabel
schwarz.../TS



Textil-Kabel
weiß.../TW



Textil-Kabel
schwarz-weiß.../TSW

Eine klassische Leuchte mit Reflektor in abgeflachter Kegelform.

Reflektor der Originaltype „Berlin“ mit verkleinertem Fassungs-aufbau. Ihre reduzierte, klare Form ist wie geschaffen für die Beleuchtung von kleineren Tischen und besonderen Plätzen.



Sievering einfach

<p>Abgebildete Leuchte: Reflektor-Ø 300 mm, aus veredeltem Stahlblech, außen Tiefschwarz (S/S), innen Reinweiß, schwarz-weißes Textil-Kabel (TSW) 1,5 m lang, mit Metall-Baldachin Halbkugel Ø 80 mm</p> <p>Mit hochwertiger Porzellanfassung E27, für Glühlampen bis max. 100 Watt</p>	<p>Reflektor-Ø / Leuchtenhöhe 300 mm / 160 mm</p> <p>Sonderausführungen auf Anfrage</p>	<p>Lieferung bei allen Aufhängungen komplett mit klassischem Baldachin</p> 	 E27  E27  230 V 50 Hz  IP 20   elektrische Bauteile geprüft
--	--	---	---

Materialien - Oberflächen

Stahlblech beschichtet / lackiert



Tiefschwarz
S/S



Reinweiß, RAL 9010
S/W

Sonderlackierung in RAL-Farbtönen möglich

Stahlblech natur



Klarlack matt
S/M



Klarlack glänzend
S/G

Aufhängungen



Kabel-Aufhängung
K/...



Alu-Gussaufhängung
mit vernickelter Kette
AGK/...



Alu-Gussaufhängung
mit Stahlseil
AGS/...

Kabelvarianten zu den Aufhängungen



PVC-Kabel
schwarz.../PS



PVC-Kabel
weiß.../PW



Textil-Kabel
schwarz.../TS



Textil-Kabel
weiß.../TW









Textil-Kabel
schwarz-weiß.../TSW

Eine zurückhaltende Leuchte in doppelter Kegelform. Aus traditionell gefertigten Guss- und Drückteilen sowie einzelnen Porzellanelementen. Ihre reduzierte, klare Form verleiht ihr eine zeitlose Wirkung und erlaubt den Einsatz in unterschiedlichsten Bereichen.



Passau

<p>Abgebildete Leuchte: Reflektor-Ø 450 mm, aus veredeltem Stahlblech, außen Tiefschwarz (S/S), innen Reinweiß, Alu-Gussaufhängung mit vernickelter Kette (AGK), schwarz-weißes Textil-Kabel (TSW) 1,5 m lang, mit Metall-Baldachin in Kegelform Ø 100 mm</p> <p>Mit hochwertiger Porzellanfassung E27, für Glühlampen bis max. 100 Watt</p>	<p>Reflektor-Ø / Leuchtenhöhe 350 mm / 230 mm 450 mm / 300 mm</p> <p>Sonderausführungen auf Anfrage</p>	<p>Lieferung bei allen Aufhängungen komplett mit Baldachin in Kegelform</p> 	 E27  E27  230 V 50 Hz  IP 20  elektrische Bauteile geprüft
---	--	--	--

Materialien - Oberflächen

Stahlblech beschichtet / lackiert

 Tiefschwarz S/S

 Reinweiß, RAL 9010 S/W

Sonderlackierung in RAL-Farbtönen möglich

Aluminium natur

 ohne Lackierung A/R

 Klarlack matt A/M

 Klarlack glänzend A/G

Stahlblech natur

 Klarlack matt S/M

 Klarlack glänzend S/G

Kupfer natur

 ohne Lackierung K/R

 Klarlack matt K/M

 Klarlack glänzend K/G

Aufhängungen: Kabel/Kupferkette

Aufhängungen



Kabel-Aufhängung K/...



Alu-Gussaufhängung mit vernickelter Kette AGK/...



Alu-Gussaufhängung mit Stahlseil AGS/...



Alu-Kabel-Box mit vernickelter Kette ABK/...



Alu-Kabel-Box mit Seilaufhänger ABS

Kabelvarianten zu den Aufhängungen



PVC-Kabel schwarz.../PS



PVC-Kabel weiß.../PW

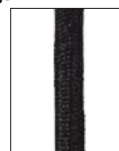

Textil-Kabel schwarz.../TS



Textil-Kabel weiß.../TW

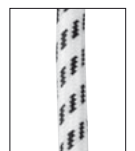

Textil-Kabel schwarz-weiß.../TSW

Diese klassische Leuchte wird in einer Einheit als Fassungsdom mit gerundetem Übergang zum bauchigen Reflektor nahtlos auf einer Form gedrückt.
Eine Reflektorleuchte mit zeitlosen Rundungen in einer besonderen Formensprache.



Baden

<p>Abgebildete Leuchte: Reflektor-Ø 400 mm, aus veredeltem Stahlblech, außen Tiefschwarz (S/S), innen Reinweiß, Alu-Gussaufhängung mit vernickelter Kette (AGK), schwarz-weißes Textil-Kabel (TSW) 1,5 m lang, mit Metall-Baldachin Halbkugel Ø 80 mm</p> <p>Mit hochwertiger Porzellanfassung E27, für Glühlampen bis max. 100 Watt</p>	<p>Reflektor-Ø / Leuchtenhöhe 300 mm / 200 mm 400 mm / 320 mm</p>	<p>Lieferung bei allen Aufhängungen komplett mit klassischem Baldachin</p>	<p>E27</p> <p>E27</p> <p>230 V 50 Hz</p> <p>IP 20</p> <p>elektrische Bauteile geprüft</p>
<p>Sonderausführungen auf Anfrage</p>			

Materialien - Oberflächen

Stahlblech beschichtet / lackiert

- Tiefschwarz S/S
- Reinweiß, RAL 9010 S/W

Sonderlackierung in RAL-Farbtönen möglich

Aluminium natur

- ohne Lackierung A/R
- Klarlack matt A/M
- Klarlack glänzend A/G

Stahlblech natur

- Klarlack matt S/M
- Klarlack glänzend S/G

Aufhängungen

- Kabel-Aufhängung K/...
- Alu-Gussaufhängung mit vernickelter Kette AGK/...
- Alu-Gussaufhängung mit Stahlseil AGS/...
- Alu-Kabel-Box mit vernickelter Kette ABK/...
- Alu-Kabel-Box mit Seilaufhänger ABS

Kabelvarianten zu den Aufhängungen

- PVC-Kabel schwarz.../PS
- PVC-Kabel weiß.../PW
- Textil-Kabel schwarz.../TS
- Textil-Kabel weiß.../TW
- Textil-Kabel schwarz-weiß.../TSW

Die optisch auf das Wesentliche reduzierte Leuchte mit flachem Reflektor und runder Kuppel besticht durch ihre elegante Klarheit. Aus traditionell gefertigten Drückteilen sowie hochwertigen Porzellanelementen. Die reduzierte Form macht sie zu einem Klassiker.



Josefstadt

<p>Abgebildete Leuchte: Reflektor-Ø 350 mm, aus veredeltem Stahlblech, außen Tiefschwarz (S/S), innen Reinweiß, schwarz-weißes Textil-Kabel (TSW), mit Metall-Baldachin Halbkugel Ø 80 mm</p> <p>Mit hochwertiger Porzellanfassung E27, für Glühlampen bis max. 100 Watt</p>	<p>Reflektor-Ø / Reflektorhöhe</p> <table border="0"> <tr><td>160 mm</td><td>/</td><td>92 mm</td></tr> <tr><td>200 mm</td><td>/</td><td>105 mm</td></tr> <tr><td>250 mm</td><td>/</td><td>108 mm</td></tr> <tr><td>300 mm</td><td>/</td><td>111 mm</td></tr> <tr><td>350 mm</td><td>/</td><td>116 mm</td></tr> <tr><td>400 mm</td><td>/</td><td>127 mm</td></tr> </table> <p>Sonderausführungen auf Anfrage</p>	160 mm	/	92 mm	200 mm	/	105 mm	250 mm	/	108 mm	300 mm	/	111 mm	350 mm	/	116 mm	400 mm	/	127 mm	<p>Lieferung bei allen Aufhängungen komplett mit klassischem Baldachin</p> 	  <p>E27 E27</p> <p>CE 230 V 50 Hz</p>  <p>IP 20</p>   <p>elektrische Bauteile geprüft</p>
160 mm	/	92 mm																			
200 mm	/	105 mm																			
250 mm	/	108 mm																			
300 mm	/	111 mm																			
350 mm	/	116 mm																			
400 mm	/	127 mm																			

Materialien - Oberflächen

Stahlblech beschichtet / lackiert

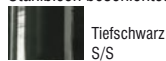

Sonderlackierung in RAL-Farbtönen möglich

Aluminium natur

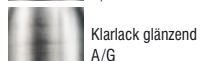
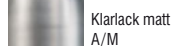

Stahlblech natur

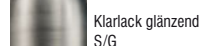
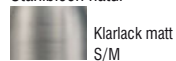

Kupfer natur



Aufhängungen: Kabel/Kupferkette

Aufhängungen



Kabel-Aufhängung
K/...



Alu-Gussaufhängung
mit vernickelter Kette
AGK/...



Alu-Gussaufhängung
mit Stahlseil
AGS/...



PVC-Kabel
schwarz.../PS



PVC-Kabel
weiß.../PW



Textil-Kabel
schwarz.../TS



Textil-Kabel
weiß.../TW

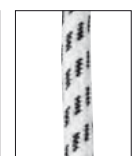





Textil-Kabel
schwarz-weiß.../TSW

Die optisch auf das Wesentliche reduzierte Leuchte mit flachem Reflektor und runder Kuppel besticht durch ihre elegante Klarheit.

Aus traditionell gefertigten Drückteilen sowie hochwertigen Porzellanelementen. Die Kombination mit dem Pendelrohr ergibt eine stabile Verbindung zur Decke.

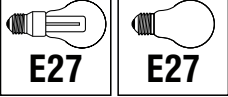

Josefstadt Pendelrohr

<p>Abgebildete Leuchte: Reflektor-Ø 350 mm, aus veredeltem Stahlblech, außen Tiefschwarz (S/S), innen Reinweiß, 1000 mm Pendelrohrabhängung Ø 16 mm, mit Metall-Baldachin Halbkugel Ø 80 mm</p> <p>Mit hochwertiger Porzellanfassung E27, für Glühlampen bis max. 100 Watt</p>	<p>Reflektor-Ø / Reflektorhöhe 160 mm / 92 mm 200 mm / 105 mm 250 mm / 108 mm 300 mm / 111 mm 350 mm / 116 mm 400 mm / 127 mm</p> <p>Pendelrohrlänge (ohne Leuchte) 500 mm 750 mm 1000 mm 1500 mm</p> <p>Extras • Sonderlängen des Pendelrohrs auf Wunsch</p> <p>Sonderausführungen auf Anfrage</p>	<p>Lieferung komplett mit klassischem Baldachin</p> 	 <p>E27 E27</p> <p>CE 230 V 50 Hz</p> <p> IP 20</p> <p>  elektrische Bauteile geprüft</p>
---	--	--	---

Materialien - Oberflächen

Stahlblech beschichtet / lackiert



Tiefschwarz
S/S



Reinweiß, RAL 9010
S/W

Sonderlackierung in RAL-Farbtönen möglich

Aluminium natur



ohne Lackierung
A/R



Klarlack matt
A/M



Klarlack glänzend
A/G

Stahlblech natur



Klarlack matt
S/M



Klarlack glänzend
S/G

Kupfer natur



ohne Lackierung
K/R



Klarlack matt
K/M



Klarlack glänzend
K/G



Josefstadt Gelenk

<p>Abgebildete Leuchte: Reflektor-Ø 350 mm, aus veredeltem Stahlblech, außen Tiefschwarz (S/S), innen Reinweiß, 500 mm Pendelrohrabhängung Ø 16 mm, Zahngelenke Messing vernickelt (Z/MN) am Reflektor (aR) und an Alu-Gussrossette (aG) Ø 100 mm</p> <p>Mit hochwertiger Porzellanfassung E27, für Glühlampen bis max. 100 Watt</p>	<p>Reflektor-Ø / Reflektorhöhe 160 mm / 92 mm 200 mm / 105 mm 250 mm / 108 mm 300 mm / 111 mm 350 mm / 116 mm 400 mm / 127 mm</p> <p>Pendelrohrlänge (ohne Leuchte) 250 mm 750 mm 500 mm 1000 mm</p> <p>Extras</p> <ul style="list-style-type: none"> • Sonderlängen der Pendelrohre auf Wunsch • Beliebig mit Zahngelenken kombinierbar <p>Sonderausführungen auf Anfrage</p>	<p>Rosette der Kupfer-Varianten</p> 	 <p>E27 E27</p>  <p>CE 230 V 50 Hz</p> <p>IP 20</p>  <p>VDE elektrische Bauteile geprüft</p>
---	---	--	--

Materialien - Oberflächen

Stahlblech beschichtet / lackiert

 Tiefschwarz
S/S

 Reinweiß, RAL 9010
S/W

Sonderlackierung in RAL-Farbtönen möglich

Aluminium natur

 ohne Lackierung
A/R

 Klarlack matt
A/M

 Klarlack glänzend
A/G

Stahlblech natur

 Klarlack matt
S/M

 Klarlack glänzend
S/G



Zahngelenk



Messing poliert
Z/MP



Messing vernickelt
Z/MN

Anordnung



am Reflektor .../aR



am Pendelrohr .../aP



an Gussrossette .../aG

Eine klassische Leuchte mit Reflektor in abgeflachter Kegelform. Aus traditionell gefertigten Guss- und Drückteilen sowie einzelnen Porzellanelementen. Die ausgeprägten Formen der in der Drück- und Sickingentechnik erzeugten Kubaturen verleihen ihr eine ganz besondere Ausdruckskraft.

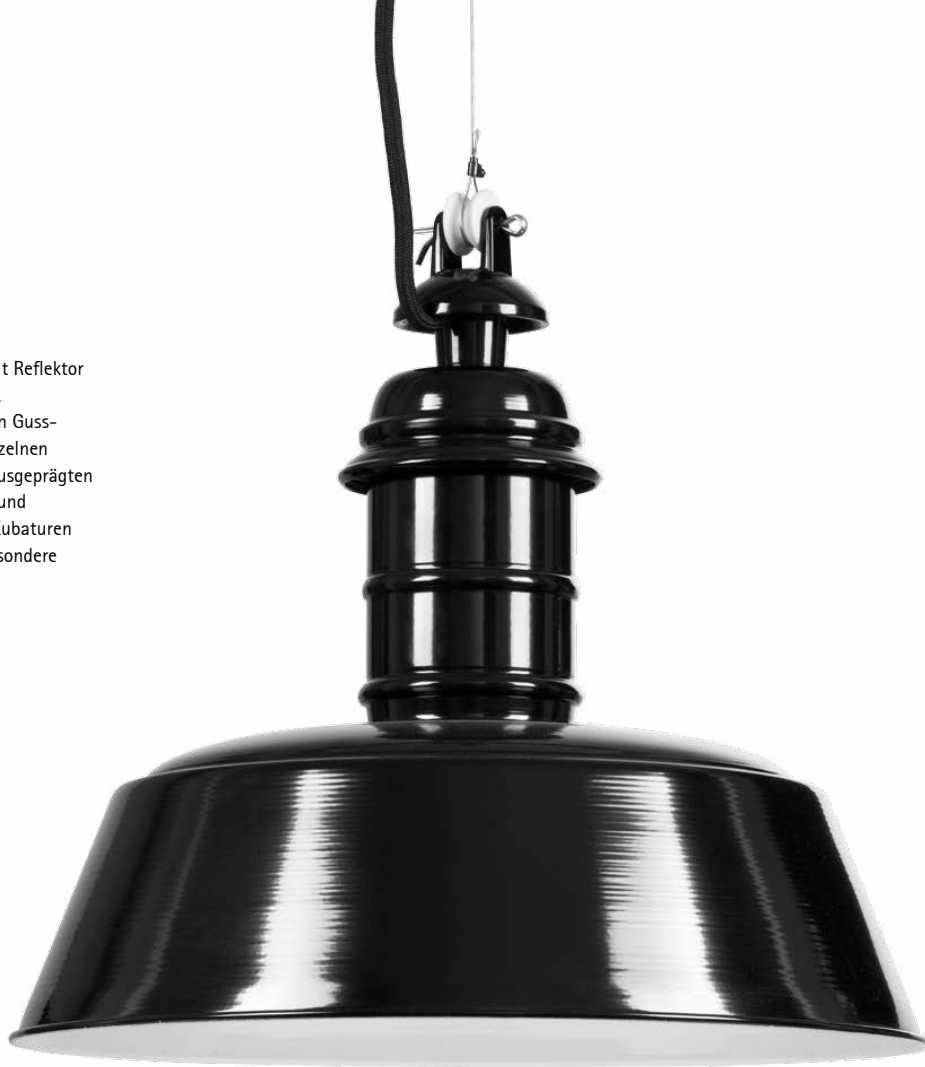

Korneuburg

<p>Abgebildete Leuchte: Reflektor-Ø 350 mm, aus veredeltem Stahlblech, außen Tiefschwarz (S/S), innen Reinweiß, Alu-Gussaufhängung mit Stahlseil (AGS), schwarzes Textil-Kabel (TS) 1,5 m lang, mit Metall-Baldachin Halbkugel Ø 80 mm</p> <p>Mit hochwertiger Porzellanfassung E27, für Glühlampen bis max. 100 Watt</p>	<p>Reflektor-Ø / Leuchtenhöhe 300 mm / 250 mm 350 mm / 260 mm</p> <p>Haupttype</p> <p>Sonderausführungen auf Anfrage</p>	<p>Lieferung bei allen Aufhängungen komplett mit klassischem Baldachin</p>	<p>E27 E27</p> <p>CE 230 V 50 Hz</p> <p>IP 20</p> <p>elektrische Bauteile geprüft</p>
--	---	--	---

Materialien - Oberflächen

Stahlblech beschichtet / lackiert

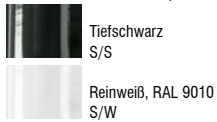

Sonderlackierung in RAL-Farbtönen möglich

Aluminium natur

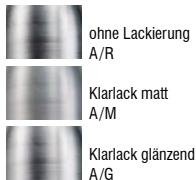

Stahlblech natur



Kupfer natur

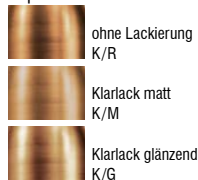

Aufhängungen: Kabel/Kupferkette

Aufhängungen



Kabel-Aufhängung K/...
Alu-Gussaufhängung mit vernickelter Kette AGK/...
Alu-Gussaufhängung mit Stahlseil AGS/...
Alu-Kabel-Box mit vernickelter Kette ABK/...
Alu-Kabel-Box mit Seilaufhänger ABS

Kabelvarianten zu den Aufhängungen

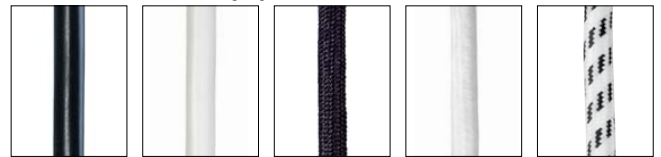

PVC-Kabel schwarz.../PS
PVC-Kabel weiß.../PW
Textil-Kabel schwarz.../TS
Textil-Kabel weiß.../TW
Textil-Kabel schwarz-weiß.../TSW

Die zeitlose Leuchte mit kegelförmigem Schirm und runder Kuppel besticht durch ihre klassische Eleganz. Aus traditionell gefertigten Drückteilen sowie hochwertigen Porzellanelementen. Die klare Form macht sie zu einem zeitlosen Klassiker.



Währing

<p>Abgebildete Leuchte: Reflektor-Ø 240 mm, aus veredeltem Stahlblech, außen Tiefschwarz (S/S), innen Reinweiß, schwarz-weißes Textil-Kabel (TSW), mit Metall-Baldachin Halbku- gel Ø 80 mm</p> <p>Mit hochwertiger Porzellanfassung E27, für Glühlampen bis max. 100 Watt</p>	<p>Reflektor-Ø / Reflektorhöhe 160 mm / 116 mm 200 mm / 129 mm 240 mm / 145 mm</p> <p>Sonderausführungen auf Anfrage</p>	<p>Lieferung bei allen Aufhängungen komplett mit klassischem Baldachin</p> 	 <p>E27 E27</p>  <p>230 V 50 Hz</p>  <p>IP 20</p>  <p>elektrische Bauteile geprüft</p>
---	---	---	---

Materialien - Oberflächen

Stahlblech beschichtet / lackiert



Tiefschwarz
S/S



Reinweiß, RAL 9010
S/W

Sonderlackierung in RAL-Farbtönen möglich

Aluminium natur



ohne Lackierung
A/R



Klarlack matt
A/M



Klarlack glänzend
A/G

Stahlblech natur



Klarlack matt
S/M



Klarlack glänzend
S/G

Kupfer natur



ohne Lackierung
K/R



Klarlack matt
K/M



Klarlack glänzend
K/G

Aufhängungen: Kabel/Kupferkette

Aufhängungen



Kabel-Aufhängung
K/...



Alu-Gussaufhängung
mit vernickelter Kette
AGK/...



Alu-Gussaufhängung
mit Stahlseil
AGS/...

Kabelvarianten zu den Aufhängungen



PVC-Kabel
schwarz.../PS



PVC-Kabel
weiß.../PW



Textil-Kabel
schwarz.../TS



Textil-Kabel
weiß.../TW



Textil-Kabel
schwarz-weiß.../TSW

Die zeitlose Leuchte mit kegelförmigem Schirm und runder Kuppel besticht durch ihre klassische Eleganz. Aus traditionell gefertigten Druckteilen sowie hochwertigen Porzellanelementen. Die Kombination mit dem Pendelrohr ergibt eine stabile Verbindung zur Decke.



Währing I

<p>Abgebildete Leuchte: Reflektor-Ø 240 mm, aus veredeltem Stahlblech, außen Tiefschwarz (S/S), innen Reinweiß, 1000 mm Pendelrohrabhängung Ø 16 mm, mit Metall-Baldachin Halbkugel Ø 80 mm</p> <p>Mit hochwertiger Porzellanfassung E27, für Glühlampen bis max. 100 Watt</p>	<p>Reflektor-Ø / Reflektorhöhe 160 mm / 116 mm 200 mm / 129 mm 240 mm / 145 mm</p> <p>Pendelrohrlänge (ohne Leuchte) 500 mm 750 mm 1000 mm 1500 mm</p> <p>Extras • Sonderlängen des Pendelrohrs auf Wunsch</p> <p>Sonderausführungen auf Anfrage</p>	<p>Lieferung komplett mit klassischem Baldachin</p> 	 <p>E27 E27</p>  <p>CE 230 V 50 Hz</p> <p>IP 20</p>  <p>VDE elektrische Bauteile geprüft</p>
---	---	--	--

Materialien - Oberflächen

Stahlblech beschichtet / lackiert



Tiefschwarz
S/S



Reinweiß, RAL 9010
S/W

Sonderlackierung in RAL-Farbtönen möglich

Stahlblech natur



Klarlack matt
S/M



Klarlack glänzend
S/G

Aluminium natur



ohne Lackierung
A/R



Klarlack matt
A/M



Klarlack glänzend
A/G

Kupfer natur



ohne Lackierung
K/R



Klarlack matt
K/M



Klarlack glänzend
K/G

Die zeitlose Leuchte mit kegelförmigem Schirm und runder Kuppel besticht durch ihre klassische Eleganz. Aus traditionell gefertigten Druckteilen sowie hochwertigen Porzellanelementen. Durch die Kombination von Pendelrohr(en) und Zahngelenk(en) ist ihr Neigungswinkel flexibel.



Währing I Gelenk

<p>Abgebildete Leuchte: Reflektor-Ø 240 mm, aus veredeltem Stahlblech, außen Tiefschwarz (S/S), innen Reinweiß, 500 mm Pendelrohrabhängung Ø 16 mm, Zahngelenk Messing vernickelt (Z/MN) am Reflektor (aR), mit Alu-Gussrossette Ø 100 mm</p> <p>Mit hochwertiger Porzellanfassung E27, für Glühlampen bis max. 100 Watt</p>	<p>Reflektor-Ø / Reflektorhöhe 160 mm / 116 mm 200 mm / 129 mm 240 mm / 145 mm</p> <p>Pendelrohrlänge (ohne Leuchte) 250 mm 500 mm 750 mm 1000 mm</p> <p>Extras</p> <ul style="list-style-type: none"> • Sonderlängen der Pendelrohre auf Wunsch • Beliebig mit Zahngelenken kombinierbar <p>Sonderausführungen auf Anfrage</p>	<p>Rosette der Kupfer-Varianten</p> 	 <p>E27 E27</p>  <p>CE 230 V 50 Hz</p> <p>IP 20</p>  <p>VDE elektrische Bauteile geprüft</p>
---	--	--	--

Materialien - Oberflächen

Stahlblech beschichtet / lackiert



Tiefschwarz
S/S



Reinweiß, RAL 9010
S/W

Sonderlackierung in RAL-Farbtönen möglich

Aluminium natur



ohne Lackierung
A/R



Klarlack matt
A/M



Klarlack glänzend
A/G

Stahlblech natur



Klarlack matt
S/M



Klarlack glänzend
S/G

Kupfer natur



ohne Lackierung
K/R



Klarlack matt
K/M



Klarlack glänzend
K/G

Zahngelenk



Messing poliert
Z/MP



Messing vernickelt
Z/MN

Anordnung



am Reflektor .../aR



am Pendelrohr .../aP



an Gussrossette .../aG

Die konstruktiv und optisch auf das Wesentliche reduzierte Leuchte mit flachem Reflektor und Bügelfassung besticht durch ihre einfache Klarheit. Aus traditionell gefertigten Metallteilen sowie hochwertigen Porzellanelementen. Das reizvolle Zusammenspiel von Porzellan und Metall macht sie zu einem schlichten Klassiker.



Wieden

<p>Abgebildete Leuchte: Reflektor-Ø 300 mm, aus veredeltem Stahlblech, außen Tiefschwarz (S/S), innen Reinweiß, Porzellanbügelfassung mit vernickelter Kette (PK), schwarzes Textil-Kabel (TS) 1,5 m lang, mit Metall-Baldachin Halbkugel Ø 80 mm</p> <p>Mit hochwertiger Porzellanfassung E27, für Glühlampen bis max. 100 Watt</p>	<p>Reflektor-Ø / Reflektorhöhe</p> <table border="0"> <tr><td>160 mm</td><td>/ 22 mm</td></tr> <tr><td>200 mm</td><td>/ 35 mm</td></tr> <tr><td>250 mm</td><td>/ 38 mm</td></tr> <tr><td>300 mm</td><td>/ 41 mm</td></tr> <tr><td>350 mm</td><td>/ 46 mm</td></tr> <tr><td>400 mm</td><td>/ 57 mm</td></tr> </table> <p>Sonderausführungen auf Anfrage</p>	160 mm	/ 22 mm	200 mm	/ 35 mm	250 mm	/ 38 mm	300 mm	/ 41 mm	350 mm	/ 46 mm	400 mm	/ 57 mm	<p>Lieferung bei allen Aufhängungen komplett mit klassischem Baldachin</p>	<p>E27 E27</p> <p>CE 230 V 50 Hz</p> <p> IP 20</p> <p> elektrische Bauteile geprüft</p>
160 mm	/ 22 mm														
200 mm	/ 35 mm														
250 mm	/ 38 mm														
300 mm	/ 41 mm														
350 mm	/ 46 mm														
400 mm	/ 57 mm														

Materialien - Oberflächen

Stahlblech beschichtet / lackiert



Sonderlackierung in RAL-Farbtönen möglich

Aluminium natur

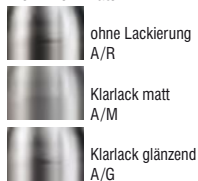

Stahlblech natur



Kupfer natur



Aufhängungen: Kabel/Kupferkette

Aufhängungen

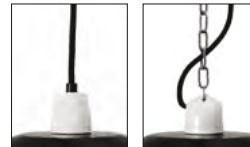

Porzellanfassung P/...

Porzellanbügelfassung mit Kette PK/...

Kabelvarianten zu den Aufhängungen

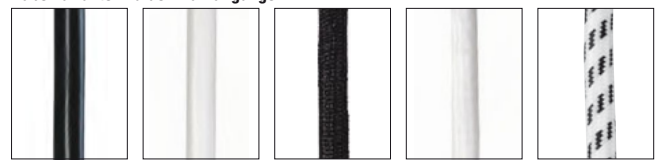

PVC-Kabel schwarz.../PS

PVC-Kabel weiß.../PW

Textil-Kabel schwarz.../TS

Textil-Kabel weiß.../TW

Textil-Kabel schwarz-weiß.../TSW

Die konstruktiv und optisch auf das Wesentliche reduzierte Leuchte mit flachem Reflektor und Pendelrohr besticht durch ihre einfache Klarheit. Aus traditionell gefertigten Metallteilen sowie hochwertigen Porzellanelementen. Das reizvolle Zusammenspiel von Porzellan und Metall macht sie zu einem schlichten Klassiker.



Wieden Pendelrohr

<p>Abgebildete Leuchte: Reflektor-Ø 160 mm, aus veredeltem Stahlblech, außen Tiefschwarz (S/S), innen Reinweiß, 1000 mm Pendelrohrabhängung Ø 13 mm, mit Metall-Baldachin Halbkugel Ø 80 mm</p> <p>Mit hochwertiger Porzellanfassung E27, für Glühlampen bis max. 100 Watt</p>	<p>Reflektor-Ø / Reflektorhöhe 160 mm / 22 mm 200 mm / 35 mm 250 mm / 38 mm 300 mm / 41 mm 350 mm / 46 mm 400 mm / 57 mm</p> <p>Abhängehöhe Decke bis Unterkante Reflektor 500 mm 750 mm 1000 mm 1500 mm</p> <p>Sonderausführungen auf Anfrage</p>	<p>Lieferung komplett mit klassischem Baldachin</p> 	 <p>E27 E27</p> <p>CE 230 V 50 Hz</p> <p> IP 20</p> <p> elektrische Bauteile geprüft</p>
---	--	--	---

Materialien - Oberflächen

Stahlblech beschichtet / lackiert

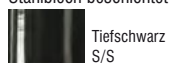

Sonderlackierung in RAL-Farbtönen möglich

Stahlblech natur

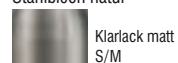

Die konstruktiv und optisch auf das Wesentliche reduzierte Leuchte mit zwei flachen Reflektoren und Pendelrohr besticht durch ihre einfache Klarheit.

Aus traditionell gefertigten Metallteilen sowie hochwertigen Porzellanelementen. Das reizvolle Zusammenspiel von Porzellan und Metall macht sie zu einem schlichten Klassiker.



Wieden II

<p>Abgebildete Leuchte: Reflektoren-Ø 160 mm, aus veredeltem Stahlblech, außen Tiefschwarz (S/S), innen Reinweiß, 1000 mm Pendelrohrabhängung Ø 13 mm, Verbindungsrohre zu den Fassungen Ø 10 mm, Fassungsabstand 400 mm, mit Metall-Baldachin Halbkugel Ø 80 mm</p> <p>Mit hochwertiger Porzellanfassung E27, für Glühlampen bis max. 100 Watt</p>	<p>Reflektor-Ø / Reflektorhöhe 160 mm / 22 mm 200 mm / 35 mm 250 mm / 38 mm 300 mm / 41 mm</p> <p>Abhängenhöhe Decke bis Unterkante Reflektor 500 mm 750 mm 1000 mm 1500 mm</p> <p>Sonderausführungen auf Anfrage</p>	<p>Lieferung komplett mit klassischem Baldachin</p> 	 <p>E27 E27</p>  <p>CE 230 V 50 Hz</p> <p>IP 20</p>  <p>VDE elektrische Bauteile geprüft</p>
--	---	--	--

Materialien - Oberflächen

Stahlblech beschichtet / lackiert



Tiefschwarz
S/S



Reinweiß, RAL 9010
S/W

Sonderlackierung in RAL-Farbtönen möglich

Stahlblech natur



Klarlack matt
S/M



Klarlack glänzend
S/G

Die konstruktiv und optisch auf das Wesentliche reduzierte Leuchte mit drei flachen Reflektoren und Pendelrohr besticht durch ihre einfache Klarheit. Aus traditionell gefertigten Metallteilen sowie hochwertigen Porzellanelementen. Das reizvolle Zusammenspiel von Porzellan und Metall macht sie zu einem schlichten Klassiker.



Wieden III

<p>Abgebildete Leuchte: Reflektoren-Ø 160 mm, aus veredeltem Stahlblech, außen Tiefschwarz (S/S), innen Reinweiß, 1000 mm Pendelrohrabhängung Ø 13 mm, Verbindungsrohre zu den Fassungen Ø 10 mm, Abstand vom Mittelrohr zu den Fassungen jeweils 200 mm, mit Metall-Baldachin Halbkugel Ø 80 mm</p> <p>Mit hochwertiger Porzellanfassung E27, für Glühlampen bis max. 100 Watt</p>	<p>Reflektor-Ø / Reflektorhöhe 160 mm / 22 mm 200 mm / 35 mm 250 mm / 38 mm 300 mm / 41 mm</p> <p>Abhängenhöhe Decke bis Unterkante Reflektor 500 mm 750 mm 1000 mm 1500 mm</p> <p>Sonderausführungen auf Anfrage</p>	<p>Lieferung komplett mit klassischem Baldachin</p> 	 <p>E27 E27</p> <p>CE 230 V 50 Hz</p> <p>IP 20</p> <p>elektrische Bauteile geprüft</p>
--	---	--	---

Materialien - Oberflächen

Stahlblech beschichtet / lackiert

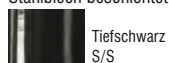

Sonderlackierung in RAL-Farbtönen möglich

Stahlblech natur

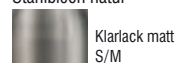

Eine zeitlose Leuchte mit kegel-
förmigem Schirm und Porzellanfassung.
Aus traditionell gefertigten
Drückteilen sowie hochwertigen
Porzellanen. Besonders in der
tiefschwarzen Variante besticht sie
durch ihre Klarheit in Form und Farbe.



Donaustadt

<p>Abgebildete Leuchte: Reflektor-Ø 240 mm, aus veredeltem Stahlblech, außen Tiefschwarz (S/S), innen Reinweiß, Porzellanfassung (P), schwarzes Textil-Kabel (TS) 1,5 m lang, mit Metall- Baldachin Halbkugel Ø 80 mm</p> <p>Mit hochwertiger Porzellanfassung E27, für Glühlampen bis max. 100 Watt</p>	<p>Reflektor-Ø / Reflektorhöhe 160 mm / 54 mm 200 mm / 67 mm 240 mm / 83 mm</p> <p>Sonderausführungen auf Anfrage</p>	<p>Lieferung bei allen Aufhängungen komplett mit klassischem Baldachin</p> 	  <p>E27 E27</p>  <p>230 V 50 Hz</p>  <p>IP 20</p>  <p>elektrische Bauteile geprüft</p>
---	--	---	---

Materialien - Oberflächen

Stahlblech beschichtet / lackiert

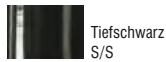

Sonderlackierung in RAL-Farbtönen möglich

Aluminium natur

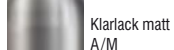

Stahlblech natur

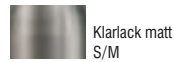

Kupfer natur

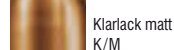
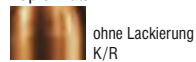

Aufhängungen: Kabel/Kupferkette

Aufhängungen



Kabelvarianten zu den Aufhängungen

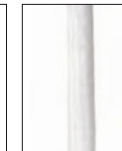
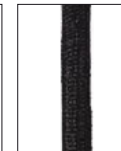

Eine schlichte Leuchte mit gewölbtem Schirm und Porzellanfassung. Aus traditionell gefertigten Drückteilen sowie hochwertigen Porzellanelementen. Besonders in der tiefschwarzen Variante besticht sie durch ihre Harmonie in Form und Farbe.



Floridsdorf

<p>Abgebildete Leuchte: Reflektor-Ø 260 mm, aus veredeltem Stahlblech, außen Tiefschwarz (S/S), innen Reinweiß, Porzellanfassung (P), schwarzes Textil-Kabel (TS) 1,5 m lang, mit Metall-Baldachin Halbkugel Ø 80 mm</p> <p>Mit hochwertiger Porzellanfassung E27, für Glühlampen bis max. 100 Watt</p>	<p>Reflektor-Ø / Reflektorhöhe 200 mm / 25 mm 260 mm / 60 mm</p> <p>Sonderausführungen auf Anfrage</p>	<p>Lieferung bei allen Aufhängungen komplett mit klassischem Baldachin</p>	<p>E27 E27</p> <p>CE 230 V 50 Hz</p> <p>IP 20</p> <p>elektrische Bauteile geprüft</p>
--	---	--	---

Materialien - Oberflächen

Stahlblech beschichtet / lackiert

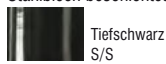

Sonderlackierung in RAL-Farbtönen möglich

Aluminium natur

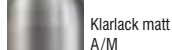

Stahlblech natur

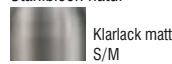

Kupfer natur

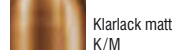
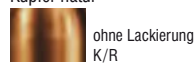

Aufhängungen: Kabel/Kupferkette

Aufhängungen



Porzellanfassung P/...



Porzellanbügelfassung mit Kette PK/...

Kabelvarianten zu den Aufhängungen



PVC-Kabel schwarz.../PS



PVC-Kabel weiß.../PW

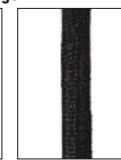

Textil-Kabel schwarz.../TS

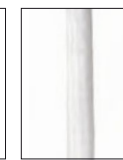

Textil-Kabel weiß.../TW



Textil-Kabel schwarz-weiß.../TSW

Eine universelle Leuchte mit flachem Reflektor und opalem Schraubglas in Kugelform.

Aus traditionell gefertigten Guss- und Drückteilen sowie einzelnen Porzellanelementen. Dort, wo noch Wert auf klassische Details gelegt wird, ist sie nicht wegzudenken.



Krems Kugel

<p>Abgebildete Leuchte: Reflektor-Ø 250 mm, aus veredeltem Stahlblech, außen Tiefschwarz (S/S), innen Reinweiß, opales Kugelglas bis 60 Watt, Alu-Gussaufhängung mit vernickelter Kette (AGK), schwarzes Textil-Kabel (TS) 1,5 m lang, mit Metall-Baldachin Halbkugel Ø 80 mm</p> <p>Mit hochwertiger Porzellanfassung E27, für Glühlampen bis max. 60/100 Watt</p>	<p>Reflektor-Ø 250 mm 300 mm 350 mm 400 mm</p> <p>Glas-Ø / Leuchtenhöhe mit Glas 160 mm / 200 mm (max. 60 Watt) 180 mm / 230 mm (max. 100 Watt)</p> <p>Sonderausführungen auf Anfrage</p>	<p>Lieferung bei allen Aufhängungen komplett mit klassischem Baldachin</p> 	  <p>E27 E27</p>  <p>230 V 50 Hz</p>  <p>IP 20</p>  <p>elektrische Bauteile geprüft</p>
--	---	---	--

Materialien - Oberflächen

Stahlblech beschichtet / lackiert

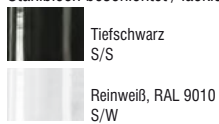

Sonderlackierung in RAL-Farbtönen möglich

Aluminium natur

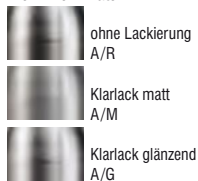

Stahlblech natur



Kupfer natur



Aufhängungen: Kabel/Kupferkette

Aufhängungen



Kabel-Aufhängung K/...
Alu-Gussaufhängung mit vernickelter Kette AGK/...
Alu-Gussaufhängung mit Stahlschlüssel AGS/...
Alu-Kabel-Box mit vernickelter Kette ABK/...
Alu-Kabel-Box mit Seilaufhänger ABS

Kabelvarianten zu den Aufhängungen

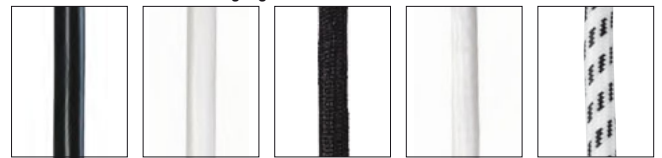

PVC-Kabel schwarz.../PS
PVC-Kabel weiß.../PW
Textil-Kabel schwarz.../TS
Textil-Kabel weiß.../TW
Textil-Kabel schwarz-weiß.../TSW

Eine robuste Leuchte mit flachem Reflektor und Schraubglas in Zylinderform.
 Aus traditionell gefertigten Guss- und Drückteilen sowie einzelnen Porzellanelementen. Dort, wo noch Wert auf stimmige Details gelegt wird, ist sie nicht wegzudenken.



Krems Zylinder

<p>Abgebildete Leuchte: Reflektor-Ø 250 mm, aus veredeltem Stahlblech, außen Tiefschwarz (S/S), innen Reinweiß, mattiertes Zylinderglas bis 60 Watt, Alu-Gussaufhängung mit vernickelter Kette (AGK), schwarzes Textil-Kabel (TS) 1,5 m lang, mit Metall-Baldachin Halbkugel Ø 80 mm</p> <p>Mit hochwertiger Porzellanfassung E27, für Glühlampen bis max. 60/100 Watt</p>	<p>Reflektor-Ø 250 mm 300 mm 350 mm 400 mm</p> <p>Glas-Ø / Leuchtenhöhe mit Glas 100 mm / 200 mm (max. 60 Watt) 110 mm / 230 mm (max. 100 Watt)</p> <p>Extras • Zylinderglas auch in Klar lieferbar</p> <p>Sonderausführungen auf Anfrage</p>	<p>Lieferung bei allen Aufhängungen komplett mit klassischem Baldachin</p> 	 <p>E27 E27</p>  <p>CE 230 V 50 Hz IP 20</p> <p>elektrische Bauteile geprüft</p>
--	---	---	--

Materialien - Oberflächen

Stahlblech beschichtet / lackiert

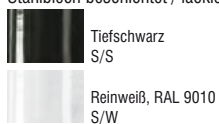

Sonderlackierung in RAL-Farbtönen möglich

Aluminium natur

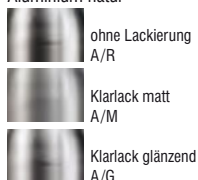

Stahlblech natur



Kupfer natur



Aufhängungen: Kabel/Kupferkette

Aufhängungen



Kabel-Aufhängung K/...
 Alu-Gussaufhängung mit vernickelter Kette AGK/...
 Alu-Gussaufhängung mit Stahlseil AGS/...
 Alu-Kabel-Box mit vernickelter Kette ABK/...
 Alu-Kabel-Box mit Seilaufhänger ABS

Kabelvarianten zu den Aufhängungen

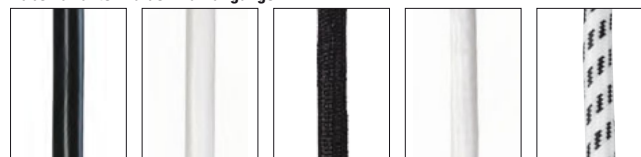

PVC-Kabel schwarz.../PS
 PVC-Kabel weiß.../PW
 Textil-Kabel schwarz.../TS
 Textil-Kabel weiß.../TW
 Textil-Kabel schwarz-weiß.../TSW

Eine robuste Leuchte mit zwei flachen Reflektoren mit Schraubgläsern in Zylinderform und Pendelrohrabhangung. Aus traditionell gefertigten Guss- und Drückteilen sowie einzelnen Porzellanelementen. Dort, wo noch Wert auf stimmige Details gelegt wird, ist sie nicht wegzudenken.



Krems Zylinder II

<p>Abgebildete Leuchte: Reflektoren-Ø 350 mm, aus veredeltem Stahlblech, außen Tiefschwarz (S/S), innen Reinweiß, klare Zylindergläser bis 100 Watt, 1000 mm Pendelrohrabhangung Ø 16 mm, Pendelarmbreite 1000 mm (PW1000), Gesamtbreite 1350 mm, Zahngelenk Messing poliert (Z/MP), mit Metall-Baldachin Halbkugel Ø 100 mm</p> <p>Mit hochwertiger Porzellanfassung E27, für Glühlampen bis max. 60/100 Watt</p>	<p>Reflektor-Ø 250 mm 350 mm 300 mm 400 mm</p> <p>Glas-Ø / Leuchtenhöhe mit Glas 100 mm / 200 mm (max. 60 Watt) 110 mm / 230 mm (max. 100 Watt)</p> <p>Abhängehöhe Decke bis Unterkante Leuchte 650 mm 1000 mm 750 mm 1500 mm</p> <p>Extras • Zylinderglas auch in Matt lieferbar • Sonderlängen der Pendelrohrabhangung möglich Sonderausführungen auf Anfrage</p>	<p>Lieferung komplett mit klassischem Baldachin</p> 	<table border="1"> <tr> <td> E27</td> <td> E27</td> </tr> <tr> <td></td> <td>230 V 50 Hz</td> </tr> <tr> <td></td> <td>IP 54</td> </tr> <tr> <td colspan="2">  elektrische Bauteile geprüft</td> </tr> </table>	 E27	 E27		230 V 50 Hz		IP 54	  elektrische Bauteile geprüft	
 E27	 E27										
	230 V 50 Hz										
	IP 54										
  elektrische Bauteile geprüft											

Materialien - Oberflächen

Stahlblech beschichtet / lackiert

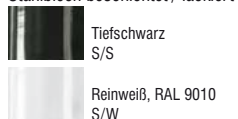

Sonderlackierung in RAL-Farbtönen möglich

Stahlblech natur



Aluminium natur

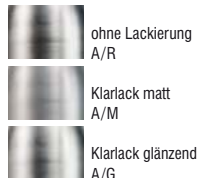

Kupfer natur

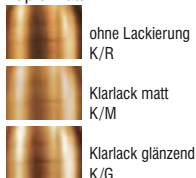

Mittelflansch: RAL (nach Wunsch)

Breite Best.-Nr. Wandarmausführungen

800 mm PW0800
 1000 mm PW1000
 1200 mm PW1200



Pendelarm waagrecht, mit Zahngelenk

Zahngelenk

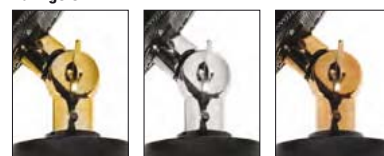

Messing poliert Z/MP

Messing vernickelt Z/MN

Messing verkupfert Z/MK

800 mm PB0800



Pendelarm geschwungen

Eine harmonische Funktionsleuchte mit kegelförmigem Gusskopf und opalem Schraubglas in Kugelform. In ihrer Reduktion auf die nötigsten Elemente besticht sie durch die Klarheit ihrer funktionalen Details.



Pulkau Kugel

<p>Abgebildete Leuchte: Leuchtenkopf Tiefschwarz (A/S), opales Kugelglas bis 60 Watt, Alu-Gussaufhängung mit vernickelter Kette (AGK), schwarzes Textil-Kabel (TS) 1,5 m lang, mit Metall-Baldachin Halbkugel Ø 80 mm</p> <p>Mit hochwertiger Porzellanfassung E27, für Glühlampen bis max. 60/100 Watt</p>	<p>Gusskopf-Ø 105 mm 120 mm</p> <p>Glas-Ø / Leuchtenhöhe mit Glas 160 mm / 200 mm (max. 60 Watt) 180 mm / 230 mm (max. 100 Watt)</p> <p>Sonderausführungen auf Anfrage</p>	<p>Lieferung bei allen Aufhängungen komplett mit klassischem Baldachin</p>	<p>E27 E27</p> <p>CE 230 V 50 Hz</p> <p>IP 20</p> <p>elektrische Bauteile geprüft</p>
--	--	--	--

Materialien - Oberflächen

Aluminium beschichtet / lackiert



Sonderlackierung in RAL-Farbtönen möglich

Aluminium natur

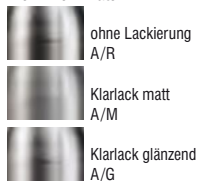

Kupfer natur



Aufhängungen: Kabel/Kupferkette

Aufhängungen



Kabel-Aufhängung K/...
Alu-Gussaufhängung mit vernickelter Kette AGK/...
Alu-Gussaufhängung mit Stahlsseil AGS/...
Alu-Kabel-Box mit vernickelter Kette ABK/...
Alu-Kabel-Box mit Seilaufhänger ABS

Kabelvarianten zu den Aufhängungen

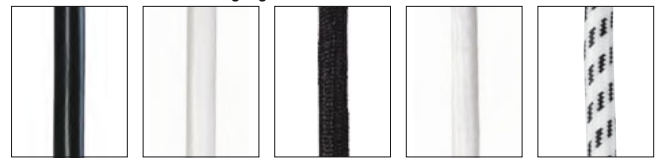

PVC-Kabel schwarz.../PS
PVC-Kabel weiß.../PW
Textil-Kabel schwarz.../TS
Textil-Kabel weiß.../TW
Textil-Kabel schwarz-weiß.../TSW

Eine einfache Funktionsleuchte mit kegelförmigem Gusskopf und Schraubglas in Zylinderform. In ihrer Reduktion auf die nötigsten Elemente besticht sie durch die Klarheit ihrer funktionalen Details.



Pulkau Zylinder

<p>Abgebildete Leuchte: Leuchtenkopf Tiefschwarz (A/S), klares Zylinderglas bis 60 Watt, Alu-Gussaufhängung mit vernickelter Kette (AGK), schwarzes Textil-Kabel (TS) 1,5 m lang, mit Metall-Baldachin Halbkugel Ø 80 mm</p> <p>Mit hochwertiger Porzellanfassung E27, für Glühlampen bis max. 60/100 Watt</p>	<p>Gusskopf-Ø 105 mm 120 mm</p> <p>Glas-Ø / Leuchtenhöhe mit Glas 100 mm / 200 mm (max. 60 Watt) 110 mm / 230 mm (max. 100 Watt)</p> <p>Extras • Zylinderglas auch in Matt lieferbar</p> <p>Sonderausführungen auf Anfrage</p>	<p>Lieferung bei allen Aufhängungen komplett mit klassischem Baldachin</p> 	 <p>E27 E27</p>  <p>CE 230 V 50 Hz IP 20</p> <p>elektrische Bauteile geprüft</p>
---	---	---	--

Materialien - Oberflächen

Aluminium beschichtet / lackiert



Sonderlackierung in RAL-Farbtönen möglich

Aluminium natur

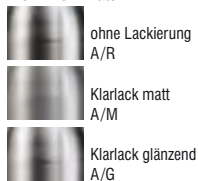

Kupfer natur



Aufhängungen: Kabel/Kupferkette

Aufhängungen



Kabel-Aufhängung K/...
Alu-Gussaufhängung mit vernickelter Kette AGK/...
Alu-Gussaufhängung mit Stahlsseil AGS/...
Alu-Kabel-Box mit vernickelter Kette ABK/...
Alu-Kabel-Box mit Seilaufhänger ABS

Kabelvarianten zu den Aufhängungen

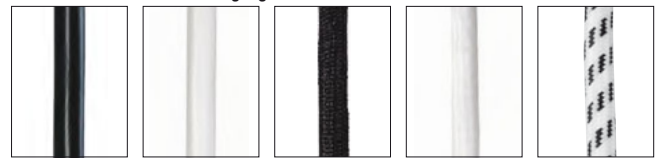

PVC-Kabel schwarz.../PS
PVC-Kabel weiß.../PW
Textil-Kabel schwarz.../TS
Textil-Kabel weiß.../TW
Textil-Kabel schwarz-weiß.../TSW

Eine von drei Richtungen anschließbare Funktionsleuchte mit kegelförmigem Gusskopf und Schraubglas in Zylinderform. In ihrer Reduktion auf die nötigsten Elemente besticht sie durch die Klarheit ihrer funktionalen Details.



Gols Zylinder

<p>Abgebildete Leuchte: Leuchtenkopf Tiefschwarz (A/S), mattiertes Zylinderglas bis 100 Watt, Alu-Gussaufhängung, seitlich mit Metall-Kabelverschraubungen PG 9 vernickelt</p> <p>Mit hochwertiger Porzellanfassung E27, für Glühlampen bis max. 100 Watt</p>	<p>Gusskopf-Ø 120 mm</p> <p>Glas-Ø / Leuchtenhöhe mit Glas 110 mm / 230 mm (max. 100 Watt)</p> <p>Spezial-Gussaufhänger Ø 80 mm, Höhe 110 mm</p> <p>Extras • Zylinderglas auch in Klar lieferbar</p> <p>Sonderausführungen auf Anfrage</p>	<p>Elektrischer Anschluss von drei Richtungen</p> 	 <p>E27 E27</p>  <p>CE 230 V 50 Hz</p> <p>IP 20</p>  <p>VDE elektrische Bauteile geprüft</p>
--	--	--	--

Materialien - Oberflächen

Aluminium beschichtet / lackiert

 Tiefschwarz
A/S

 Reinweiß, RAL 9010
A/W

Sonderlackierung in RAL-Farbtönen möglich

Eine der ersten geschlossenen Glühlampen-Leuchten, gefertigt aus veredeltem Stahlblech. Auffallend ist das sichtbar eingearbeitete Schraubgewinde für das Zylinderglas. Eine zeitlose Leuchte aus der Gründerzeit mit handwerklichem Charme. Die Form folgt hier der Funktion.



Melk Zylinder

<p>Abgebildete Leuchte: Leuchtenkopf aus veredeltem Stahlblech, Tiefschwarz (S/S), klares Zylinderglas bis 100 Watt, Alu-Gussaufhängung mit vernickelter Kette (AGK), schwarz-weißes Textil-Kabel (TSW) 1,5 m lang, mit Metall-Baldachin Halbkugel Ø 80 mm</p> <p>Mit hochwertiger Porzellanfassung E27, für Glühlampen bis max. 100 Watt</p>	<p>Leuchten-Ø 110 mm</p> <p>Glas-Ø / Leuchtenhöhe mit Glas 110 mm / 220 mm (max. 100 Watt)</p> <p>Extras • Zylinderglas auch in Matt lieferbar</p> <p>Sonderausführungen auf Anfrage</p>	<p>Lieferung bei allen Aufhängungen komplett mit klassischem Baldachin</p>	<p>E27</p> <p>E27</p> <p>CE 230 V 50 Hz</p> <p>IP 20</p> <p>elektrische Bauteile geprüft</p>
--	---	--	--

Materialien - Oberflächen

Stahlblech beschichtet / lackiert

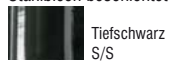

Sonderlackierung in RAL-Farbtönen möglich

Stahlblech natur

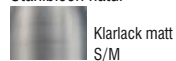

Aufhängungen



Kabel-Aufhängung K/...



Alu-Gussaufhängung mit vernickelter Kette AGK/...



Alu-Gussaufhängung mit Stahlseil AGS/...

Kabelvarianten zu den Aufhängungen



PVC-Kabel schwarz.../PS



PVC-Kabel weiß.../PW



Textil-Kabel schwarz.../TS



Textil-Kabel weiß.../TW



Textil-Kabel schwarz-weiß.../TSW

Die Leuchte mit ihrem verspielt geschwungenen Schirm gehört zu unseren besonderen Klassikern. Aus traditionell gefertigten Guss- und Drückteilen sowie hochwertigen Porzellanelementen. Die ausgeprägten Formen der in der Drück- und Sickttechnik erzeugten Kubaturen verleihen ihr eine ganz besondere Ausdruckskraft.



Schwechat

<p>Abgebildete Leuchte: Reflektor-Ø 350 mm, aus veredeltem Stahlblech, außen Tiefschwarz (S/S), innen Reinweiß, Alu-Gussaufhängung mit vernickelter Kette (AGK), schwarzes Textil-Kabel (TS) 1,5 m lang, mit Metall-Baldachin Halbkugel Ø 80 mm</p> <p>Mit hochwertiger Porzellanfassung E27, für Glühlampen bis max. 100 Watt</p>	<p>Reflektor-Ø / Leuchtenhöhe 350 mm / 270 mm</p>	<p>Lieferung bei allen Aufhängungen komplett mit klassischem Baldachin</p>	<p>E27 E27</p> <p>CE 230 V 50 Hz</p> <p>IP 20</p> <p>elektrische Bauteile geprüft</p>
<p>Sonderausführungen auf Anfrage</p>			

Materialien - Oberflächen

Stahlblech beschichtet / lackiert



Sonderlackierung in RAL-Farbtönen möglich

Aluminium natur

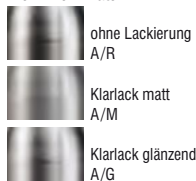

Stahlblech natur



Kupfer natur



Aufhängungen: Kabel/Kupferkette

Aufhängungen



Kabel-Aufhängung K/...
Alu-Gussaufhängung mit vernickelter Kette AGK/...
Alu-Gussaufhängung mit Stahlseil AGS/...
Alu-Kabel-Box mit vernickelter Kette ABK/...
Alu-Kabel-Box mit Seilaufhänger ABS

Kabelvarianten zu den Aufhängungen

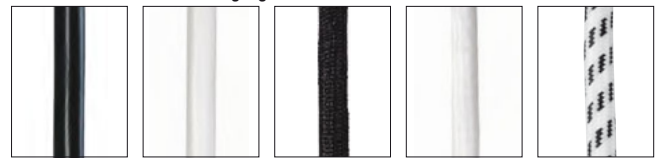

PVC-Kabel schwarz.../PS
PVC-Kabel weiß.../PW
Textil-Kabel schwarz.../TS
Textil-Kabel weiß.../TW
Textil-Kabel schwarz-weiß.../TSW

Eine dominante Leuchte mit Halbkugel-Schirm und erhöhtem Aufsatz. Aus traditionell gefertigten Guss- und Drückteilen sowie einzelnen Porzellanelementen. Sanft geschwungene konvex-konkave Formen und ihre funktionale Reduktion machen sie bis heute zu einem beliebten Klassiker für Hallen von Fertigung bis Showroom.



Klagenfurt Typ 2

<p>Abgebildete Leuchte: Reflektor-Ø 350 mm, aus veredeltem Stahlblech, außen Tiefschwarz (S/S), innen Reinweiß, Alu-Kabel-Box mit vernickelter Kette (ABK), schwarzes PVC-Kabel (PS) 1,5 m lang, mit Metall-Baldachin Halbkugel Ø 80 mm</p> <p>Mit hochwertiger Porzellanfassung E27, für Glühlampen bis max. 100 Watt</p>	<p>Reflektor-Ø / Leuchtenhöhe 300 mm / 325 mm 350 mm / 350 mm</p> <p>Extras</p> <ul style="list-style-type: none"> • Aufbau auch geeignet für Sonderbestückungen mit Vorschaltgeräten <p>Sonderausführungen auf Anfrage</p>	<p>Lieferung bei allen Aufhängungen komplett mit klassischem Baldachin</p>	<p>E27 E27</p> <p>CE 230 V 50 Hz</p> <p>IP 20</p> <p>elektrische Bauteile geprüft</p>
---	--	--	--

Materialien - Oberflächen

Stahlblech beschichtet / lackiert

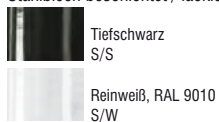

Sonderlackierung in RAL-Farbtönen möglich

Aluminium natur

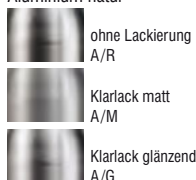

Stahlblech natur



Kupfer natur



Aufhängungen: Kabel/Kupferkette

Aufhängungen



Kabel-Aufhängung K/...
Alu-Gussaufhängung mit vernickelter Kette AGK/...
Alu-Gussaufhängung mit Stahlseil AGS/...
Alu-Kabel-Box mit vernickelter Kette ABK/...
Alu-Kabel-Box mit Seilaufhänger ABS

Kabelvarianten zu den Aufhängungen

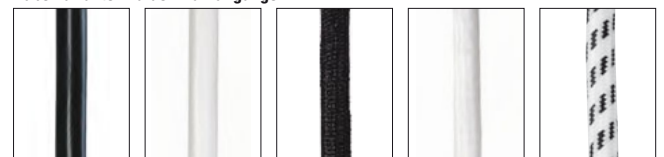

PVC-Kabel schwarz.../PS
PVC-Kabel weiß.../PW
Textil-Kabel schwarz.../TS
Textil-Kabel weiß.../TW
Textil-Kabel schwarz-weiß.../TSW

Die für ihre Zeit typische Leuchte legt ihren Schwerpunkt auf einfache Formen und Fügungen. Aus traditionell gefertigten Drückteilen sowie einzelnen Porzellanelementen. Auch wenn es nichts gibt, was nicht einer eindeutigen Funktion folgt, besteht diese Hängeleuchte gerade durch die Klarheit ihrer Form und Fertigung.



Penzing

<p>Abgebildete Leuchte: Reflektor-Ø 150 mm, aus veredeltem Stahlblech, außen Tiefschwarz (S/S), innen Reinweiß, schwarzes PVC-Kabel (PS) 1,5 m lang, mit Metall-Baldachin Halbkugel Ø 80 mm</p> <p>Mit hochwertiger Porzellanfassung E27, für Glühlampen bis max. 100 Watt</p>	<p>Reflektor-Ø / Leuchtenhöhe 150 mm / 150 mm</p> <p>Sonderausführungen auf Anfrage</p>	<p>Lieferung bei allen Aufhängungen komplett mit klassischem Baldachin</p> 	 E27  E27  230 V 50 Hz  IP 20   elektrische Bauteile geprüft
---	--	---	---

Materialien - Oberflächen

Stahlblech beschichtet / lackiert



Tiefschwarz
S/S



Reinweiß, RAL 9010
S/W

Sonderlackierung in RAL-Farbtönen möglich

Aluminium natur



ohne Lackierung
A/R



Klarlack matt
A/M



Klarlack glänzend
A/G

Stahlblech natur



Klarlack matt
S/M



Klarlack glänzend
S/G

Kupfer natur



ohne Lackierung
K/R



Klarlack matt
K/M



Klarlack glänzend
K/G

Aufhängungen: Kabel/Kupferkette

Aufhängungen



Kabel-Aufhängung
K/...



Alu-Gussaufhängung
mit vernickelter Kette
AGK/...



Alu-Gussaufhängung
mit Stahlseil
AGS/...

Kabelvarianten zu den Aufhängungen

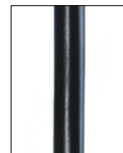

PVC-Kabel
schwarz.../PS



PVC-Kabel
weiß.../PW



Textil-Kabel
schwarz.../TS



Textil-Kabel
weiß.../TW



Textil-Kabel
schwarz-weiß.../TSW

Die für ihre Zeit typische Funktionsleuchte mit 2 schräg beschnittenen Reflektoren und Pendelrohren.
Aus traditionell gefertigten Guss- und Drückteilen sowie einzelnen Porzellanelementen. Durch die Gelenke ist diese Leuchte nach allen Seiten ganz besonders flexibel.



Penzing II Gelenk

<p>Abgebildete Leuchte: Reflektoren-Ø 150 mm, aus veredeltem Stahlblech, außen Tiefschwarz (S/S), innen Reinweiß, je 250 mm Pendelrohrabhängung Ø 16 mm, Kugelgelenke Messing vernickelt am Reflektor, Zahnengelenke Messing vernickelt (Z/MN) am Pendelrohr (aP) und an Alu-Gussrosette (aG) in Langform 175 x 55 mm</p> <p>Mit hochwertiger Porzellanfassung E27, für Glühlampen bis max. 100 Watt</p>	<p>Reflektor-Ø / Reflektorhöhe 150 mm / 150 mm</p> <p>Pendelrohrlänge (ohne Leuchte) 250 mm 500 mm 750 mm 1000 mm</p> <p>Extras</p> <ul style="list-style-type: none"> • Sonderlängen der Pendelrohre auf Wunsch • Beliebig mit Zahnengelenken kombinierbar <p>Sonderausführungen auf Anfrage</p>	<p>Mit Alu-Gussrosette in Langform</p> 	 E27  E27  230 V 50 Hz  IP 20   elektrische Bauteile geprüft
---	--	---	---

Materialien - Oberflächen

Stahlblech beschichtet / lackiert



Tiefschwarz
S/S

Reinweiß, RAL 9010
S/W

Sonderlackierung in RAL-Farbtönen möglich

Stahlblech natur



Klarlack matt
S/M

Klarlack glänzend
S/G

Zahngelenk



Messing poliert
Z/MP



Messing vernickelt
Z/MN

Anordnung



am Pendelrohr .../aP

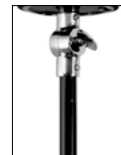

an Gussrosette .../aG

Die Leuchte mit Halbkugel-Reflektor und erhöhtem Kuppelaufsatz beeindruckt durch ihr Spiel mit Form und Größe.

Aus traditionell gefertigten Guss- und Drückteilen sowie einzelnen Porzellanelementen. Dort, wo in Zweckbauten und anderen großen Räumlichkeiten noch Wert auf stimmige Details gelegt wird, bietet sie eine prägnante Abrundung.



Klagenfurt Typ 1

<p>Abgebildete Leuchte: Reflektor-Ø 500 mm, aus veredeltem Stahlblech, außen Tiefschwarz (S/S), innen Reinweiß, Alu-Kabel-Box mit vernickelter Kette (ABK), schwarzes Textil-Kabel (TS) 1,5 m lang, mit Metall-Baldachin Halbkugel Ø 80 mm</p> <p>Mit hochwertiger Porzellanfassung E27, für Glühlampen bis max. 100 Watt</p>	<p>Reflektor-Ø / Leuchtenhöhe 350 mm / 375 mm 400 mm / 400 mm 500 mm / 450 mm Haupttypen</p> <p>Extras • E40 für Glühlampen bis 1000 Watt bei Ø 500 mm mit Kabel-Box • Aufbau auch geeignet für Sonderbestückungen mit Vorschaltgeräten</p> <p>Sonderausführungen auf Anfrage</p>	<p>Lieferung bei allen Aufhängungen komplett mit klassischem Baldachin</p>	
--	---	--	--

Materialien - Oberflächen

Stahlblech beschichtet / lackiert

	Tiefschwarz S/S
	Reinweiß, RAL 9010 S/W

Sonderlackierung in RAL-Farbtönen möglich

Aluminium natur

	ohne Lackierung A/R
	Klarlack matt A/M
	Klarlack glänzend A/G

Stahlblech natur

	Klarlack matt S/M
	Klarlack glänzend S/G

Kupfer natur

	ohne Lackierung K/R
	Klarlack matt K/M
	Klarlack glänzend K/G

Aufhängungen: Kabel/Kupferkette

Aufhängungen

Kabel-Aufhängung K/...	Alu-Gussaufhängung mit vernickelter Kette AGK/...	Alu-Gussaufhängung mit Stahlseil AGS/...	Alu-Kabel-Box mit vernickelter Kette ABK/...	Alu-Kabel-Box mit Seilaufhänger ABS

Kabelvarianten zu den Aufhängungen

PVC-Kabel schwarz.../PS	PVC-Kabel weiß.../PW	Textil-Kabel schwarz.../TS	Textil-Kabel weiß.../TW	Textil-Kabel schwarz-weiß.../TSW

Die Leuchte mit Reflektor rückt ihr elegantes opales Ring-Glas in den Vordergrund.

Aus traditionell gefertigten Guss- und Drückteilen sowie einzelnen Porzellanelementen. Das nach unten offene zylindrische Opalglas kontrastiert besonders schön in der tiefschwarzen Variante mit dem für die Entstehungszeit schlichten Aufbau.



Klagenfurt Glas Typ 3

<p>Abgebildete Leuchte: Reflektor-Ø 420 mm, aus veredeltem Stahlblech, außen Tiefschwarz (S/S), innen Reinweiß, Alu-Gussaufhängung mit vernickelter Kette (AGK), schwarzes PVC-Kabel (PS) 1,5 m lang, mit Metall-Baldachin Halbkugel Ø 80 mm</p> <p>Mit hochwertiger Porzellanfassung E27, für Glühlampen bis max. 100 Watt</p>	<p>Reflektor-Ø / Leuchtenhöhe mit Glas 420 mm / 410 mm</p> <p>Glas-Ø / Glashöhe 260 mm / 200 mm</p> <p>Extras</p> <ul style="list-style-type: none"> • E40 für Glühlampen bis 1000 Watt mit Kabel-Box • Aufbau auch geeignet für Sonderbestückungen mit Vorschaltgeräten <p>Sonderausführungen auf Anfrage</p>	<p>Lieferung bei allen Aufhängungen komplett mit klassischem Baldachin</p> 	   <p>elektrische Bauteile geprüft</p>
--	---	---	---

Materialien - Oberflächen

Stahlblech beschichtet / lackiert

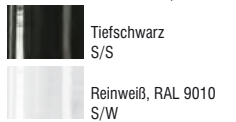

Sonderlackierung in RAL-Farbtönen möglich

Aluminium natur

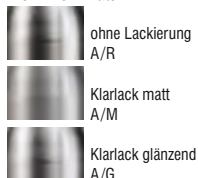

Stahlblech natur



Kupfer natur



Aufhängungen: Kabel/Kupferkette

Aufhängungen



Kabel-Aufhängung K/...
Alu-Gussaufhängung mit vernickelter Kette AGK/...
Alu-Gussaufhängung mit Stahlschlüssel AGS/...
Alu-Kabel-Box mit vernickelter Kette ABK/...
Alu-Kabel-Box mit Seilaufhänger ABS

Kabelvarianten zu den Aufhängungen

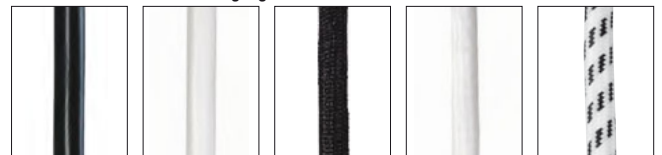

PVC-Kabel schwarz.../PS
PVC-Kabel weiß.../PW
Textil-Kabel schwarz.../TS
Textil-Kabel weiß.../TW
Textil-Kabel schwarz-weiß.../TSW

Eine offene Leuchte mit hutähnlichem Reflektor und großzügig ausgebildetem opalenem Ring-Glas.
 Aus traditionell gefertigten Guss- und Drückteilen sowie einzelnen Porzellanelementen. Besonders in der tiefschwarzen Variante kann der schlichte weiße Glasschirm seine Wirkung entfalten.



Klagenfurt Glas Typ 4

<p>Abgebildete Leuchte: Reflektor-Ø 420 mm, aus veredeltem Stahlblech, außen Tiefschwarz (S/S), innen Reinweiß, Alu-Kabel-Box mit vernickelter Kette (ABK), schwarzes Textil-Kabel (TS) 1,5 m lang, mit Metall-Baldachin Halbkugel Ø 80 mm</p> <p>Mit hochwertiger Porzellanfassung E27, für Glühlampen bis max. 100 Watt</p>	<p>Reflektor-Ø / Leuchtenhöhe mit Glas 420 mm / 385 mm</p> <p>Glas-Ø / Glashöhe 260 mm / 200 mm</p> <p>Extras</p> <ul style="list-style-type: none"> • E40 für Glühlampen bis 1000 Watt mit Kabel-Box • Aufbau auch geeignet für Sonderbestückungen mit Vorschaltgeräten <p>Sonderausführungen auf Anfrage</p>	<p>Lieferung bei allen Aufhängungen komplett mit klassischem Baldachin</p>	
---	---	--	--

Materialien - Oberflächen

Stahlblech beschichtet / lackiert

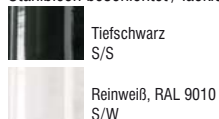

Sonderlackierung in RAL-Farbtönen möglich

Aluminium natur

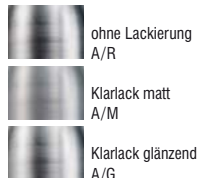

Stahlblech natur



Kupfer natur

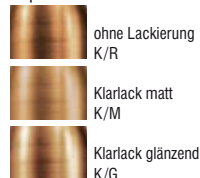

Aufhängungen: Kabel/Kupferkette

Aufhängungen



Kabel-Aufhängung K/...
 Alu-Gussaufhängung mit vernickelter Kette AGK/...
 Alu-Gussaufhängung mit Stahseil AGS/...
 Alu-Kabel-Box mit vernickelter Kette ABK/...
 Alu-Kabel-Box mit Seilaufhänger ABS

Kabelvarianten zu den Aufhängungen

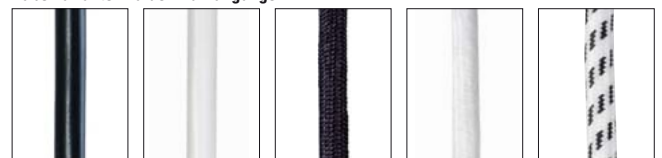

PVC-Kabel schwarz.../PS
 PVC-Kabel weiß.../PW
 Textil-Kabel schwarz.../TS
 Textil-Kabel weiß.../TW
 Textil-Kabel schwarz-weiß.../TSW

Die Leuchte mit ihrem eigenwilligen Reflektor und in den Vordergrund tretender Glühlampe ist ein besonderer Klassiker der Kollektion EBOLICHT. Optisch reduziert auf zwei traditionell gefertigte Druckteile mit sichtbaren Schraubverbindungen. Das schlichte Spiel des Doppelreflektors erlaubt es, in unterschiedlichsten Architektursprachen markante und doch zeitlose Akzente zu setzen.



Nußdorf

<p>Abgebildete Leuchte: Doppelreflektor-Ø 350 mm, aus veredeltem Stahlblech, Oberseite Tiefschwarz (S/S), Unterseite Reinweiß, schwarz-weißes Textil-Kabel (TSW) 1,5 m lang, mit Metall-Baldachin Halbkugel Ø 80 mm</p> <p>Mit hochwertiger Porzellanfassung E27, für Glühlampen bis max. 100 Watt</p>	<p>Reflektor-Ø / Leuchtenhöhe ohne Birne 300 mm / 85 mm 350 mm / 100 mm</p>	<p>Lieferung bei allen Aufhängungen komplett mit klassischem Baldachin</p>	<p>E27 E27</p> <p>CE 230 V 50 Hz</p> <p>IP 20</p> <p>elektrische Bauteile geprüft</p>
<p>Sonderausführungen auf Anfrage</p>			

Materialien - Oberflächen

Stahlblech beschichtet / lackiert

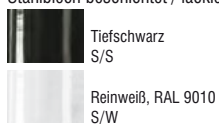

Sonderlackierung in RAL-Farbtönen möglich

Aluminium natur

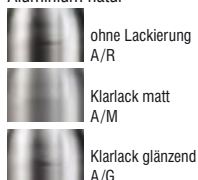

Stahlblech natur



Kupfer natur



Aufhängungen: Kabel/Kupferkette

Aufhängungen



Kabel-Aufhängung K/...
 Alu-Gussaufhängung mit vernickelter Kette AGK/...
 Alu-Gussaufhängung mit Stahlseil AGS/...

Kabelvarianten zu den Aufhängungen

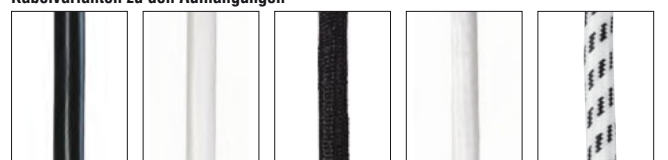

PVC-Kabel schwarz.../PS
 PVC-Kabel weiß.../PW
 Textil-Kabel schwarz.../TS
 Textil-Kabel weiß.../TW
 Textil-Kabel schwarz-weiß.../TSW

Eine klassische Hängeleuchte mit becherförmigem Reflektor und besonders filigranem Fassungs Aufbau. Aus traditionell gefertigten Druckteilen sowie einzelnen Porzellanelementen. Der tiefgezogene Reflektor sorgt für ein angenehmes und blendfreies Licht.



Döbling

<p>Abgebildete Leuchte: Reflektor-Ø 140 mm, aus veredeltem Stahlblech, außen Tiefschwarz (S/S), innen Reinweiß, schwarz-weißes Textil-Kabel (K/TSW) 1,5 m lang, mit Metall-Baldachin Halbkugel Ø 80 mm</p> <p>Mit hochwertiger Fassung E14, für Glühlampen bis max. 60 Watt</p>	<p>Reflektor-Ø / Leuchtenhöhe 140 mm / 160 mm</p> <p>Sonderausführungen auf Anfrage</p>	<p>Lieferung komplett mit klassischem Baldachin</p> 	<div style="display: flex; justify-content: space-around;"> <div style="text-align: center;">  E14 </div> <div style="text-align: center;">  E14 </div> </div> <div style="display: flex; justify-content: space-around; margin-top: 10px;"> <div style="text-align: center;">  230 V 50 Hz </div> <div style="text-align: center;">  IP 20 </div> </div> <div style="text-align: right; margin-top: 10px;">  elektrische Bauteile geprüft </div>
--	--	--	--

Materialien - Oberflächen

Stahlblech beschichtet / lackiert

 Tiefschwarz
S/S

 Reinweiß, RAL 9010
S/W

Sonderlackierung in RAL-Farbtönen möglich

Stahlblech natur

 Klarlack matt
S/M

 Klarlack glänzend
S/G

Kabelvarianten



PVC-Kabel
schwarz K/PS



PVC-Kabel
weiß K/PW



Textil-Kabel
schwarz K/TS



Textil-Kabel
weiß K/TW

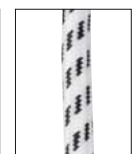

Textil-Kabel
schwarz-weiß K/TSW

Eine zeitlose Leuchte mit kegel-förmigem Schirm und Porzellanfassung. Aus traditionell gefertigten Drückteilen sowie hochwertigen Porzellanelementen. Besonders in der tiefschwarzen Variante besticht sie durch ihre Klarheit in Form und Farbe.



Leopoldau

<p>Abgebildete Leuchte: Reflektor-Ø 175 mm, aus veredeltem Stahlblech, außen Tiefschwarz (S/S), innen Reinweiß, schwarzes Textil-Kabel (TS) 1,5 m lang, mit Metall-Baldachin Halbku-gel Ø 80 mm</p> <p>Mit hochwertiger Porzellanfassung E27, für Glühlampen bis max. 100 Watt</p>	<p>Reflektor-Ø / Reflektorhöhe 175 mm / 280 mm</p> <p>Sonderausführungen auf Anfrage</p>	<p>Lieferung bei allen Aufhängungen komplett mit klassischem Baldachin</p>	 E27  E27  230 V 50 Hz  IP 20   elektrische Bauteile geprüft
---	---	--	---

Materialien - Oberflächen

Stahlblech beschichtet / lackiert



Sonderlackierung in RAL-Farbtönen möglich

Aluminium natur



Stahlblech natur

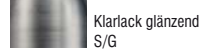
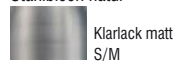

Kupfer natur

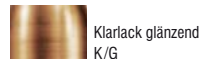
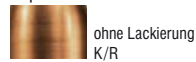

Aufhängungen: Kabel/Kupferkette

Aufhängungen



Kabel-Aufhängung
K/...



Alu-Gussaufhängung
mit vernickelter Kette
AGK/...



Alu-Gussaufhängung
mit Stahlseil
AGS/...

Kabelvarianten zu den Aufhängungen



PVC-Kabel
schwarz.../PS



PVC-Kabel
weiß.../PW



Textil-Kabel
schwarz.../TS



Textil-Kabel
weiß.../TW



Textil-Kabel
schwarz-weiß.../TSW

Eine offene Leuchte mit hutähnlichem Reflektor und großzügig ausgebildetem opalem Ring-Glas.
 Aus traditionell gefertigten Guss- und Drückteilen sowie einzelnen Porzellanelementen. Besonders in der tiefschwarzen Variante kann der schlichte weiße Glasschirm seine Wirkung entfalten.



Kapfenberg Typ 1

<p>Abgebildete Leuchte: Reflektor-Ø 400 mm, aus veredeltem Stahlblech, außen Tiefschwarz (S/S), innen Reinweiß, opales Glas, Alu-Gussaufhängung mit vernickelter Kette (AGK), schwarzes PVC-Kabel (PS) 1,5 m lang, mit Metall-Baldachin Halbkugel Ø 80 mm</p> <p>Mit hochwertiger Porzellanfassung E27, für Glühlampen bis max. 100 Watt</p>	<p>Reflektor-Ø / Leuchtenhöhe mit Glas 300mm / 230 mm 350 mm / 230 mm 400 mm / 230 mm</p> <p>Haupttypen</p> <p>Glas-Ø / Glashöhe 230 mm / 155 mm</p> <p>Sonderausführungen auf Anfrage</p>	<p>Lieferung bei allen Aufhängungen komplett mit klassischem Baldachin</p>	<p>E27 E27</p> <p>CE 230 V 50 Hz</p> <p>IP 20</p> <p>elektrische Bauteile geprüft</p>
--	--	--	---

Materialien - Oberflächen

Stahlblech beschichtet / lackiert



Sonderlackierung in RAL-Farbtönen möglich

Aluminium natur

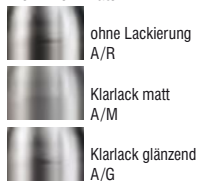

Stahlblech natur



Kupfer natur



Aufhängungen: Kabel/Kupferkette

Aufhängungen



Kabel-Aufhängung K/...
 Alu-Gussaufhängung mit vernickelter Kette AGK/...
 Alu-Gussaufhängung mit Stahlschlüssel AGS/...
 Alu-Kabel-Box mit vernickelter Kette ABK/...
 Alu-Kabel-Box mit Seilaufhänger ABS

Kabelvarianten zu den Aufhängungen

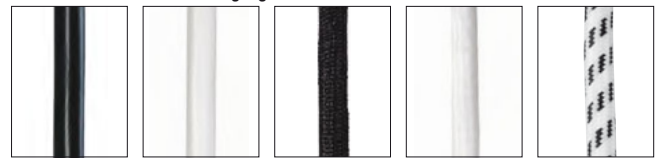

PVC-Kabel schwarz.../PS
 PVC-Kabel weiß.../PW
 Textil-Kabel schwarz.../TS
 Textil-Kabel weiß.../TW
 Textil-Kabel schwarz-weiß.../TSW

Eine kompakte Leuchte mit hutähnlichem Reflektor und unten offenem Spitzzylinder-Glas. Aus traditionell gefertigten Guss- und Drückteilen sowie einzelnen Porzellanelementen. Als Nutzleuchte überzeugt sie durch ihre ausgewogenen Proportionen.



Kapfenberg Typ 2

<p>Abgebildete Leuchte: Reflektor-Ø 400 mm, aus veredeltem Stahlblech, außen Tiefschwarz (S/S), innen Reinweiß, klares Spitzzylinder-Glas, Alu-Gussaufhängung mit vernickelter Kette (AGK), schwarzes PVC-Kabel (PS) 1,5 m lang, mit Metall-Baldachin Halbkugel Ø 80 mm</p> <p>Mit hochwertiger Porzellanfassung E27, für Glühlampen bis max. 100 Watt</p>	<p>Reflektor-Ø / Leuchtenhöhe mit Glas 300 mm / 230 mm 350 mm / 230 mm 400 mm / 230 mm</p> <p>Haupttypen</p> <p>Glas-Ø / Glashöhe 150 mm / 155 mm</p> <p>Extras • Spitzzylinder-Glas auch opalen lieferbar</p> <p>Sonderausführungen auf Anfrage</p>	<p>Lieferung bei allen Aufhängungen komplett mit klassischem Baldachin</p>	<p>E27 E27</p> <p>CE 230 V 50 Hz</p> <p>IP 20</p> <p>elektrische Bauteile geprüft</p>
--	---	--	---

Materialien - Oberflächen

Stahlblech beschichtet / lackiert



Sonderlackierung in RAL-Farbtönen möglich

Aluminium natur

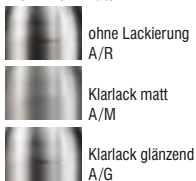

Stahlblech natur



Kupfer natur



Aufhängungen: Kabel/Kupferkette

Aufhängungen



Kabel-Aufhängung K/...
 Alu-Gussaufhängung mit vernickelter Kette AGK/...
 Alu-Gussaufhängung mit Stahlschlüssel AGS/...
 Alu-Kabel-Box mit vernickelter Kette ABK/...
 Alu-Kabel-Box mit Seilaufhänger ABS

Kabelvarianten zu den Aufhängungen

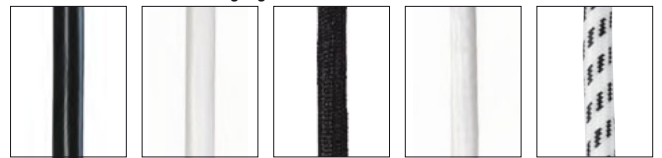

PVC-Kabel schwarz.../PS
 PVC-Kabel weiß.../PW
 Textil-Kabel schwarz.../TS
 Textil-Kabel weiß.../TW
 Textil-Kabel schwarz-weiß.../TSW

Die technisch geprägte Leuchte mit Halbkugel-Schirm und großem zylindrischem Aufsatz. Aus traditionell gefertigten Guss- und Drückteilen sowie einzelnen Porzellanelementen. In der Variante aus Aluminium ist ihr industrieller Charme besonders präsent.



Freudenau

<p>Abgebildete Leuchte: Reflektor-Ø 400 mm, aus Aluminium natur, allseits mit Klarlack matt geschützt (A/M), Alu-Kabel-Box mit vernickelter Kette (ABK), schwarz-weißes Textil-Kabel (TSW) 1,5 m lang, mit Metall-Baldachin Halbkugel Ø 80 mm</p> <p>Mit hochwertiger Porzellanfassung E27, für Glühlampen bis max. 100 Watt</p>	<p>Reflektor-Ø / Leuchtenhöhe 400 mm / 390 mm 500 mm / 440 mm</p> <p>Extras</p> <ul style="list-style-type: none"> • E40 für Glühlampen bis 1000 Watt bei Ø 500 mm mit Kabel-Box • Besonders großer Aufbau auch geeignet für Sonderbestückung mit Vorschalt- und Zündgeräten <p>Sonderausführungen auf Anfrage</p>	<p>Lieferung bei allen Aufhängungen komplett mit klassischem Baldachin</p>	<p>elektrische Bauteile geprüft</p>
---	--	--	-------------------------------------

Materialien - Oberflächen

Stahlblech beschichtet / lackiert



Sonderlackierung in RAL-Farbtönen möglich

Aluminium natur

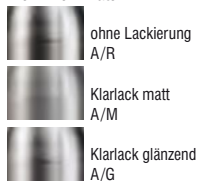

Stahlblech natur



Kupfer natur



Aufhängungen: Kabel/Kupferkette

Aufhängungen



Kabel-Aufhängung K/...
Alu-Gussaufhängung mit vernickelter Kette AGK/...
Alu-Gussaufhängung mit Stahlseil AGS/...
Alu-Kabel-Box mit vernickelter Kette ABK/...
Alu-Kabel-Box mit Seilaufhänger ABS

Kabelvarianten zu den Aufhängungen

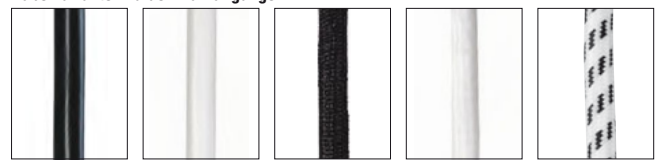

PVC-Kabel schwarz.../PS
PVC-Kabel weiß.../PW
Textil-Kabel schwarz.../TS
Textil-Kabel weiß.../TW
Textil-Kabel schwarz-weiß.../TSW

Die Leuchte mit Halbkugel-Schirm und runder Kuppel besticht durch ihr expressives Volumen. Aus traditionell gefertigten Guss- und Drückteilen sowie einzelnen Porzellanelementen. Durch den stark gewölbten Reflektor verbreitet die Leuchte ein besonders angenehmes und blendfreies Licht.

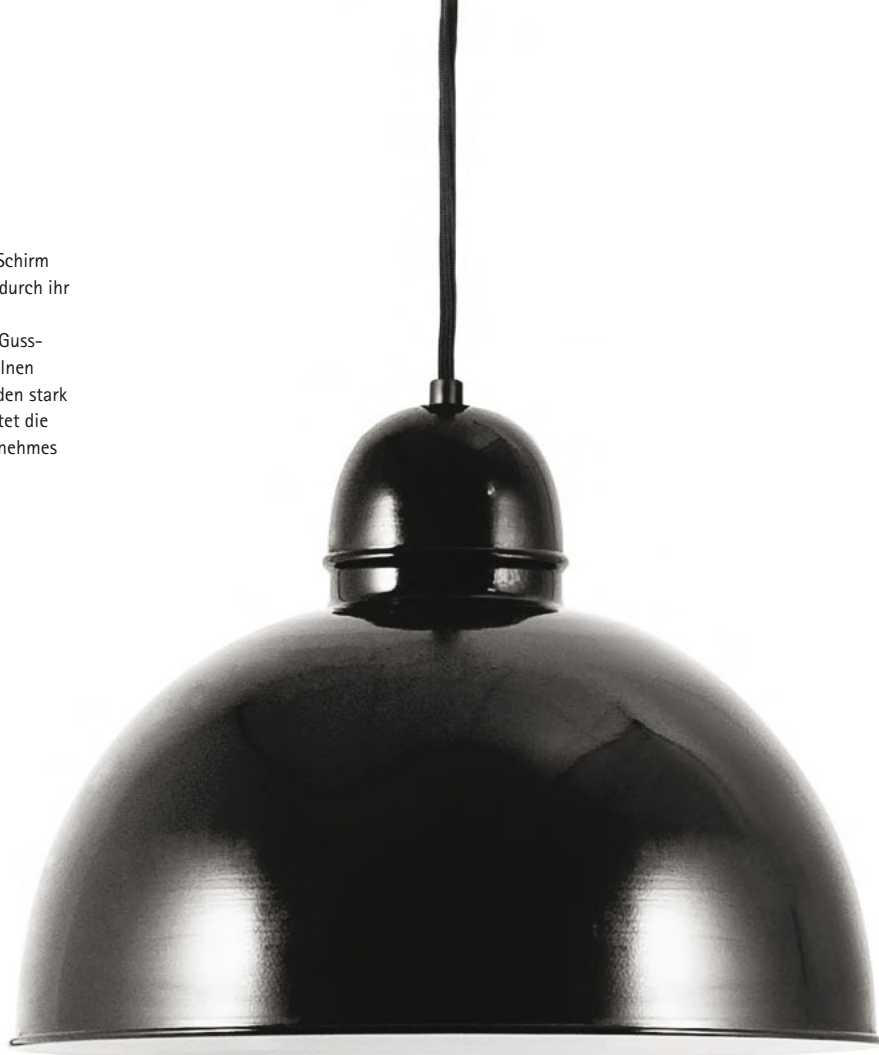

Penzing

<p>Abgebildete Leuchte: Reflektor-Ø 350 mm, aus veredeltem Stahlblech, außen Tiefschwarz (S/S), innen Reinweiß, schwarzes Textil-Kabel (TS) 1,5 m lang, mit Metall-Baldachin Halbkugel Ø 80 mm</p> <p>Mit hochwertiger Porzellanfassung E27, für Glühlampen bis max. 100 Watt</p>	<p>Reflektor-Ø / Leuchtenhöhe</p> <table border="0"> <tr><td>250 mm</td><td>/</td><td>180 mm</td></tr> <tr><td>300 mm</td><td>/</td><td>240 mm</td></tr> <tr><td>350 mm</td><td>/</td><td>255 mm</td></tr> <tr><td>400 mm</td><td>/</td><td>270 mm</td></tr> <tr><td>500 mm</td><td>/</td><td>320 mm</td></tr> </table> <p>Haupttypen</p> <p>Extras</p> <ul style="list-style-type: none"> E40 für Glühlampen bis 1000 Watt bei Ø 500 mm mit Kabel-Box <p>Sonderausführungen auf Anfrage</p>	250 mm	/	180 mm	300 mm	/	240 mm	350 mm	/	255 mm	400 mm	/	270 mm	500 mm	/	320 mm	<p>Lieferung bei allen Aufhängungen komplett mit klassischem Baldachin</p>	<table border="0"> <tr> <td> E27</td> <td> E27</td> </tr> <tr> <td> E40</td> <td> E40</td> </tr> <tr> <td> CE</td> <td> 230 V 50 Hz</td> </tr> <tr> <td> IP 20</td> <td> IP 20</td> </tr> <tr> <td colspan="2"> elektrische Bauteile geprüft</td> </tr> </table>	 E27	 E27	 E40	 E40	 CE	 230 V 50 Hz	 IP 20	 IP 20	elektrische Bauteile geprüft	
250 mm	/	180 mm																										
300 mm	/	240 mm																										
350 mm	/	255 mm																										
400 mm	/	270 mm																										
500 mm	/	320 mm																										
 E27	 E27																											
 E40	 E40																											
 CE	 230 V 50 Hz																											
 IP 20	 IP 20																											
elektrische Bauteile geprüft																												

Materialien - Oberflächen

Stahlblech beschichtet / lackiert

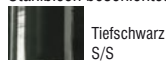

Sonderlackierung in RAL-Farbtönen möglich

Aluminium natur

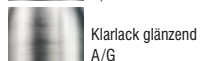
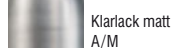

Stahlblech natur

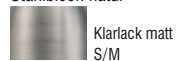

Kupfer natur



Aufhängungen: Kabel/Kupferkette

Aufhängungen



Kabel-Aufhängung K/...



Alu-Gussaufhängung mit vernickelter Kette AGK/...



Alu-Gussaufhängung mit Stahlseil AGS/...



Alu-Kabel-Box mit vernickelter Kette ABK/...



Alu-Kabel-Box mit Seilaufhänger ABS

Kabelvarianten zu den Aufhängungen



PVC-Kabel schwarz.../PS



PVC-Kabel weiß.../PW



Textil-Kabel schwarz.../TS



Textil-Kabel weiß.../TW



Textil-Kabel schwarz-weiß.../TSW

Eine eigenwillige Leuchte mit gewölbtem Reflektor und dominantem opalem Ring-Glas.
Aus traditionell gefertigten Guss- und Drückteilen sowie einzelnen Porzellanelementen. Diese Leuchte diente früher als klassische Hofleuchte.



Leoben

<p>Abgebildete Leuchte: Reflektor-Ø 250 mm, aus veredeltem Stahlblech mit Gusskopf, außen Tiefschwarz (S/S), innen Reinweiß, opalenes Glas, Alu-Gussaufhängung mit vernickelter Kette (AGK), schwarzes Textil-Kabel (TS) 1,5 m lang, mit Metall-Baldachin Halbkugel Ø 80 mm</p> <p>Mit hochwertiger Porzellanfassung E27, für Glühlampen bis max. 100 Watt</p>	<p>Reflektor-Ø / Leuchtenhöhe mit Glas 250 mm / 180 mm 300 mm / 225 mm</p> <p>Glas-Ø / Glashöhe 170 mm / 160 mm 230 mm / 225 mm</p> <p>Sonderausführungen auf Anfrage</p>	<p>Lieferung bei allen Aufhängungen komplett mit klassischem Baldachin</p>	<p>E27 E27</p> <p>elektrische Bauteile geprüft</p>
---	---	--	--

Materialien - Oberflächen

Stahlblech beschichtet / lackiert

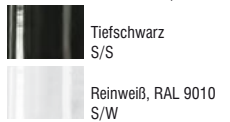

Sonderlackierung in RAL-Farbtönen möglich

Aluminium natur

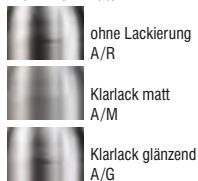

Stahlblech natur



Kupfer natur



Aufhängungen: Kabel/Kupferkette

Aufhängungen



Kabel-Aufhängung K/...
Alu-Gussaufhängung mit vernickelter Kette AGK/...
Alu-Gussaufhängung mit Stahlschlüssel AGS/...
Alu-Kabel-Box mit vernickelter Kette ABK/...
Alu-Kabel-Box mit Seilaufhänger ABS

Kabelvarianten zu den Aufhängungen

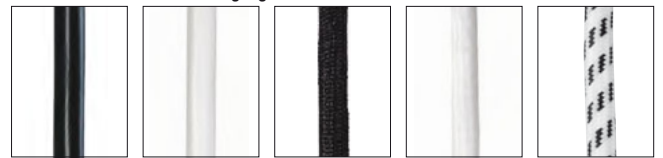

PVC-Kabel schwarz.../PS PVC-Kabel weiß.../PW Textil-Kabel schwarz.../TS Textil-Kabel weiß.../TW Textil-Kabel schwarz-weiß.../TSW

Die Leuchte mit Halbkugel-Schirm und zylindrischer Kuppel besticht durch ihr expressives Volumen. Aus traditionell gefertigten Drückteilen und einzelnen Porzellanelementen. Durch den stark gewölbten Reflektor verbreitet die Leuchte ein besonders angenehmes und blendfreies Licht.



Ottakring

<p>Abgebildete Leuchte: Reflektor-Ø 300 mm, aus veredeltem Stahlblech, außen Tiefschwarz (S/S), innen Reinweiß, schwarzes Textil-Kabel (TS) 1,5 m lang, mit Metall-Baldachin Halbkugel Ø 80 mm</p> <p>Mit hochwertiger Porzellanfassung E27, für Glühlampen bis max. 100 Watt</p>	<p>Reflektor-Ø / Leuchtenhöhe</p> <table border="0"> <tr><td>200 mm</td><td>/ 200 mm</td></tr> <tr><td>250 mm</td><td>/ 220 mm</td></tr> <tr><td>300 mm</td><td>/ 280 mm</td></tr> <tr><td>350 mm</td><td>/ 325 mm</td></tr> <tr><td>400 mm</td><td>/ 355 mm</td></tr> <tr><td>500 mm</td><td>/ 400 mm</td></tr> </table> <p>■ Haupttypen</p> <p>Extras</p> <ul style="list-style-type: none"> • E40 für Glühlampen bis 1000 Watt bei Ø 500 mm mit Kabel-Box <p>Sonderausführungen auf Anfrage</p>	200 mm	/ 200 mm	250 mm	/ 220 mm	300 mm	/ 280 mm	350 mm	/ 325 mm	400 mm	/ 355 mm	500 mm	/ 400 mm	<p>Lieferung bei allen Aufhängungen komplett mit klassischem Baldachin</p> 	<table border="0"> <tr> <td> E27</td> <td> E27</td> </tr> <tr> <td> E40</td> <td> E40</td> </tr> <tr> <td> 230 V 50 Hz</td> <td> IP 20</td> </tr> <tr> <td colspan="2">  elektrische Bauteile geprüft</td> </tr> </table>	 E27	 E27	 E40	 E40	 230 V 50 Hz	 IP 20	  elektrische Bauteile geprüft	
200 mm	/ 200 mm																						
250 mm	/ 220 mm																						
300 mm	/ 280 mm																						
350 mm	/ 325 mm																						
400 mm	/ 355 mm																						
500 mm	/ 400 mm																						
 E27	 E27																						
 E40	 E40																						
 230 V 50 Hz	 IP 20																						
  elektrische Bauteile geprüft																							

Materialien - Oberflächen

Stahlblech beschichtet / lackiert



Tiefschwarz
S/S



Reinweiß, RAL 9010
S/W

Sonderlackierung in RAL-Farbtönen möglich

Aluminium natur



ohne Lackierung
A/R



Klarlack matt
A/M



Klarlack glänzend
A/G

Stahlblech natur



Klarlack matt
S/M



Klarlack glänzend
S/G

Kupfer natur



ohne Lackierung
K/R



Klarlack matt
K/M



Klarlack glänzend
K/G

Aufhängungen: Kabel/Kupferkette

Aufhängungen



Kabel-Aufhängung
K/...



Alu-Gussaufhängung
mit vernickelter Kette
AGK/...



Alu-Gussaufhängung
mit Stahlseil
AGS/...



Alu-Kabel-Box
mit vernickelter Kette
ABK/...



Alu-Kabel-Box
mit Seilaufhänger
ABS

Kabelvarianten zu den Aufhängungen



PVC-Kabel
schwarz.../PS



PVC-Kabel
weiß.../PW



Textil-Kabel
schwarz.../TS



Textil-Kabel
weiß.../TW



Textil-Kabel
schwarz-weiß.../TSW

Eine klassisch-elegante Leuchte mit gewölbtem Schirm und opalem Schraubglas in Kugelform. Aus traditionell gefertigten Guss- und Drückteilen sowie einzelnen Porzellanelementen. Besonders in der tiefschwarzen Variante besticht sie durch die Harmonie von Form und Farbe.



Retz Kugel

<p>Abgebildete Leuchte: Reflektor-Ø 260 mm, aus veredeltem Stahlblech, außen Tiefschwarz (S/S), innen Reinweiß, opales Kugelglas bis 60 Watt, Alu-Gussaufhängung mit vernickelter Kette (AGK), schwarzes Textil-Kabel (TS) 1,5 m lang, mit Metall-Baldachin Halbkugel Ø 80 mm</p> <p>Mit hochwertiger Porzellanfassung E27, für Glühlampen bis max. 60/100 Watt</p>	<p>Reflektor-Ø 260 mm</p> <p>Glas-Ø / Leuchtenhöhe mit Glas 160 mm / 200 mm (max. 60 Watt) 180 mm / 230 mm (max. 100 Watt)</p> <p>Sonderausführungen auf Anfrage</p>	<p>Lieferung bei allen Aufhängungen komplett mit klassischem Baldachin</p>	<p>E27 E27</p> <p>CE 230 V 50 Hz</p> <p> IP 20</p> <p> elektrische Bauteile geprüft</p>
--	--	--	--

Materialien - Oberflächen

Stahlblech beschichtet / lackiert



Sonderlackierung in RAL-Farbtönen möglich

Aluminium natur

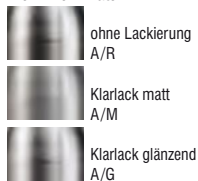

Stahlblech natur



Kupfer natur



Aufhängungen: Kabel/Kupferkette

Aufhängungen



Kabel-Aufhängung K/...
Alu-Gussaufhängung mit vernickelter Kette AGK/...
Alu-Gussaufhängung mit Stahlseil AGS/...
Alu-Kabel-Box mit vernickelter Kette ABK/...
Alu-Kabel-Box mit Seilaufhänger ABS

Kabelvarianten zu den Aufhängungen

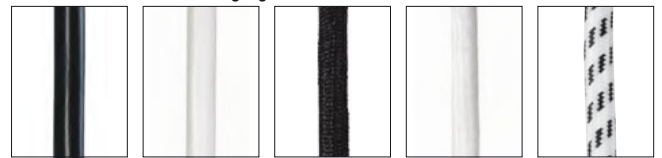

PVC-Kabel schwarz.../PS PVC-Kabel weiß.../PW Textil-Kabel schwarz.../TS Textil-Kabel weiß.../TW Textil-Kabel schwarz-weiß.../TSW

Eine schlichte Leuchte mit gewölbtem Schirm und Schraubglas in Zylinderform.
 Aus traditionell gefertigten Guss- und Drückteilen sowie einzelnen Porzellanelementen. Besonders in der tiefschwarzen Variante besticht sie durch ihre Klarheit in Form und Farbe.



Retz Zylinder

<p>Abgebildete Leuchte: Reflektor-Ø 260 mm, aus veredeltem Stahlblech, außen Tiefschwarz (S/S), innen Reinweiß, klares Zylinderglas bis 60 Watt, Alu-Gussaufhängung mit vernickelter Kette (AGK), schwarzes Textil-Kabel (TS) 1,5 m lang, mit Metall-Baldachin Halbkugel Ø 80 mm</p> <p>Mit hochwertiger Porzellanfassung E27, für Glühlampen bis max. 60/100 Watt</p>	<p>Reflektor-Ø 260 mm</p> <p>Glas-Ø / Leuchtenhöhe mit Glas 100 mm / 200 mm (max. 60 Watt) 110 mm / 230 mm (max. 100 Watt)</p> <p>Extras • Zylinderglas auch in Matt lieferbar</p> <p>Sonderausführungen auf Anfrage</p>	<p>Lieferung bei allen Aufhängungen komplett mit klassischem Baldachin</p> 	 <p>E27 E27</p>  <p>CE 230 V 50 Hz IP 20</p> <p>elektrische Bauteile geprüft</p>
--	---	---	--

Materialien - Oberflächen

Stahlblech beschichtet / lackiert

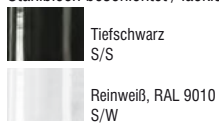

Sonderlackierung in RAL-Farbtönen möglich

Aluminium natur

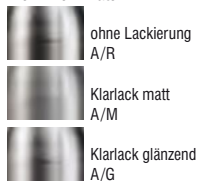

Stahlblech natur



Kupfer natur



Aufhängungen: Kabel/Kupferkette

Aufhängungen



Kabel-Aufhängung K/...
 Alu-Gussaufhängung mit vernickelter Kette AGK/...
 Alu-Gussaufhängung mit Stahlseil AGS/...
 Alu-Kabel-Box mit vernickelter Kette ABK/...
 Alu-Kabel-Box mit Seilaufhänger ABS

Kabelvarianten zu den Aufhängungen

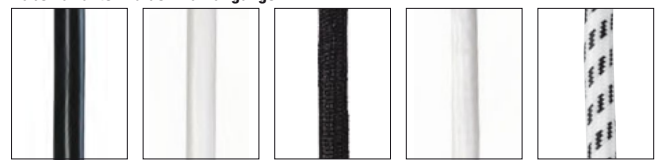



PVC-Kabel schwarz.../PS PVC-Kabel weiß.../PW Textil-Kabel schwarz.../TS Textil-Kabel weiß.../TW Textil-Kabel schwarz-weiß.../TSW

Eine schlichte einflammige Leuchte mit bewährter Standardleuchtstoffröhre. Eine der ersten Neonleuchten aus traditionell gefertigten Metallkomponenten. Durch ihre außergewöhnliche Formensprache ist sie überall dort gefragt, wo ein außergewöhnlicher Akzent zu setzen ist. In großen Räumen kommt sie ganz besonders in stringenter Reihung zur Geltung.

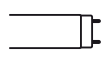
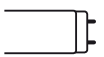

Lugeck I

<p>Abgebildete Leuchte: Leuchte 20 Watt, Metallteile aus veredeltem Stahlblech, Rohre Ø 16 mm, Tiefschwarz (S/S), 500 mm Pendelrohrabhangung Ø 16 mm, Elektrik mit verlustarmem Vorschaltgerat und Starter im Baldachin</p>	<p>Leuchtenlange / Rohrenlange 900 mm / 590 mm (20 Watt) 1510 mm / 1200 mm (40 Watt) 1810 mm / 1500 mm (65 Watt)</p> <p>Abhangehohe Decke bis Unterkante Leuchte 500 mm / 750 mm 1000 mm / 1500 mm</p>	 <p>Durch hochwertiges vernickeltes Zahn-gelenk zur Seite verstellbar</p>	<div style="display: flex; justify-content: space-around;"> <div style="border: 1px solid black; padding: 5px; text-align: center;">  T8 </div> <div style="border: 1px solid black; padding: 5px; text-align: center;">  T12 </div> </div> <div style="margin-top: 10px;"> <p>CE 230 V 50 Hz</p> <p>IP 20</p> <p> elektrische Bauteile gepruft</p> </div>
<p>Extras</p> <ul style="list-style-type: none"> • Sonderlangen der Pendelrohrabhangung moglich • Die Leuchtstoffrohre T12, Ø 38 mm, Warmton, kann mitbestellt werden <p>Sonderausfuhungen auf Anfrage</p>			

Materialien - Oberflachen

Stahlblech beschichtet / lackiert



Tiefschwarz
S/S



Reinwei, RAL 9010
S/W

Sonderlackierung in RAL-Farbtonen moglich

Stahlblech natur



Klarlack matt
S/M







Klarlack glanzend
S/G

Eine zweckbetonte zweiflämmige Variante mit bewährten Standardleuchtstoffröhren. Eine der ersten Neonleuchten aus traditionell gefertigten Metallkomponenten. Durch ihre außergewöhnliche Formensprache ist sie überall dort gefragt, wo ein außergewöhnlicher Akzent zu setzen ist. In großen Räumen kommt sie ganz besonders in stringenter Reihung zur Geltung.

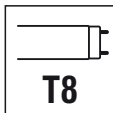
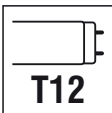

Lugeck II

<p>Abgebildete Leuchte: Leuchte 2 x 20 Watt, Metallteile aus veredeltem Stahlblech, Rohre Ø 16 mm, Tiefschwarz (S/S), 750 mm Pendelrohrabhängung Ø 16 mm, Elektrik mit verlustarmem Vorschaltgerät und Starter im Baldachin</p>	<p>Leuchtenlänge / Röhrenlänge 820 mm / 590 mm (2 x 20 Watt) 1430 mm / 1200 mm (2 x 40 Watt) 1730 mm / 1500 mm (2 x 65 Watt)</p> <p>Abhängehöhe Decke bis Unterkante Leuchte 500 mm / 750 mm 1000 mm / 1500 mm</p> <p>Extras</p> <ul style="list-style-type: none"> • Sonderlängen der Pendelrohrabhängung möglich • Die Leuchtstoffröhren T12, Ø 38 mm, Warmton, können mitbestellt werden <p>Sonderausführungen auf Anfrage</p>	 <p>Durch hochwertiges vernickeltes Zahn-gelenk zur Seite verstellbar</p>	<div style="display: flex; justify-content: space-around;"> <div style="text-align: center;">  T8 </div> <div style="text-align: center;">  T12 </div> </div> <div style="margin-top: 20px;">  230 V 50 Hz </div> <div style="margin-top: 10px;">  IP 20 </div> <div style="margin-top: 10px;">  elektrische Bauteile geprüft </div>
--	--	---	---

Materialien - Oberflächen

Stahlblech beschichtet / lackiert



Tiefschwarz
S/S



Reinweiß, RAL 9010
S/W

Sonderlackierung in RAL-Farbtönen möglich

Stahlblech natur



Klarlack matt
S/M



Klarlack glänzend
S/G

Die extravagante zweiflämmige Leuchte verschmilzt zwei verschieden lange Standardleuchtstoffröhren. Eine außergewöhnliche, unkonventionelle Lichtlösung, gefertigt aus einer der ersten Neonleuchten. Durch ihre Formensprache ist sie überall dort gefragt, wo ein besonderer Akzent zu setzen ist.



Lugeck Kreuz

<p>Abgebildete Leuchte: Leuchte 20 + 40 Watt, Metallteile aus veredeltem Stahlblech, Rohre Ø 16 mm, Tiefschwarz (S/S), 750 mm Pendelrohrabhängung Ø 16 mm, Elektrik mit verlustarmen Vorschaltgeräten und Starter im Baldachin</p>	<p>Leuchtenlänge / Leuchtenbreite 900 mm / 1510 mm (20 + 40 Watt) 900 mm / 1810 mm (20 + 65 Watt) 1510 mm / 1810 mm (40 + 65 Watt)</p> <p>Abhängehöhe Decke bis Unterkante Leuchte 650 mm / 750 mm 1000 mm / 1500 mm</p> <p>Extras</p> <ul style="list-style-type: none"> • Sonderlängen der Pendelrohrabhängung möglich • Die Leuchtstoffröhren T12, Ø 38 mm, Warmton, können mitbestellt werden <p>Sonderausführungen auf Anfrage</p>	<p>Durch hochwertige vernickelte Gelenke zur Seite verstellbar und zusätzlich zueinander stufenlos drehbar</p> 	<div style="display: flex; justify-content: space-around;"> <div style="border: 1px solid black; padding: 5px; text-align: center;">  T8 </div> <div style="border: 1px solid black; padding: 5px; text-align: center;">  T12 </div> </div> <div style="margin-top: 20px;">   </div> <div style="margin-top: 10px;">  </div> <div style="margin-top: 10px;">   elektrische Bauteile geprüft </div>
---	--	---	--

Materialien - Oberflächen

Stahlblech beschichtet / lackiert



Tiefschwarz
S/S



Reinweiß, RAL 9010
S/W

Sonderlackierung in RAL-Farbtönen möglich

Stahlblech natur



Klarlack matt
S/M



Klarlack glänzend
S/G

Die extravagante zweiflämmige Leuchte verschmilzt zwei gleich lange Standardleuchtstoffröhren. Eine außergewöhnliche, unkonventionelle Lichtlösung, gefertigt aus einer der ersten Neonleuchten. Durch ihre Formensprache ist sie überall dort gefragt, wo ein besonderer Akzent zu setzen ist.



Lugeck Plus

<p>Abgebildete Leuchte: Leuchte 2 x 20 Watt, Metallteile aus veredeltem Stahlblech, Rohre Ø 16 mm, Tiefschwarz (S/S), 750 mm Pendelrohrabhangung Ø 16 mm, Elektrik mit verlustarmem Vorschaltgerät und Starter im Baldachin</p>	<p>Leuchtenlänge / Leuchtenbreite 900 mm / 900 mm (2 x 20 Watt) 1510 mm / 1510 mm (2 x 40 Watt) 1810 mm / 1810 mm (2 x 65 Watt)</p> <p>Abhängehöhe Decke bis Unterkante Leuchte 650 mm / 750 mm 1000 mm / 1500 mm</p> <p>Extras</p> <ul style="list-style-type: none"> • Sonderlängen der Pendelrohrabhangung möglich • Die Leuchtstoffröhren T12, Ø 38 mm, Warmton, können mitbestellt werden <p>Sonderausführungen auf Anfrage</p>	<p>Durch hochwertige vernickelte Gelenke zur Seite verstellbar und zusätzlich zueinander stufenlos drehbar</p> 	<div style="display: flex; justify-content: space-around;"> <div style="border: 1px solid black; padding: 5px; text-align: center;">  T8 </div> <div style="border: 1px solid black; padding: 5px; text-align: center;">  T12 </div> </div> <div style="display: flex; justify-content: space-around; margin-top: 10px;"> <div style="border: 1px solid black; padding: 2px;">  </div> <div style="border: 1px solid black; padding: 2px;"> 230 V 50 Hz </div> </div> <div style="display: flex; justify-content: space-around; margin-top: 10px;"> <div style="border: 1px solid black; padding: 2px;">  </div> <div style="border: 1px solid black; padding: 2px;"> IP 20 </div> </div> <div style="display: flex; justify-content: space-around; margin-top: 10px;">   </div> <p style="font-size: small; text-align: right;">elektrische Bauteile geprüft</p>
--	---	---	--

Materialien - Oberflächen

Stahlblech beschichtet / lackiert



Tiefschwarz
S/S



Reinweiß, RAL 9010
S/W

Sonderlackierung in RAL-Farbtönen möglich

Stahlblech natur



Klarlack matt
S/M



Klarlack glänzend
S/G

Die extravagante sternförmige Leuchte mit acht gleich langen Standardleuchtstoffröhren.
Eine unkonventionelle Lichtlösung, gefertigt auf Basis einer der ersten Neonleuchten. Durch ihre Formensprache ist sie überall dort gefragt, wo ein besonderer Akzent zu setzen ist und viel Platz zur Verfügung steht.



Lugeck Stern

<p>Abgebildete Leuchte: Leuchte 8 x 20 Watt, Metallteile aus veredeltem Stahlblech, Röhre Ø 16 mm, Tiefschwarz (S/S), 750 mm Pendelrohrabhängung Ø 25 mm, Elektrik mit verlustarmem Vorschaltgerät und Starter im Baldachin</p>	<p>Leuchten-Ø / Röhrenlänge 1800 mm / 590 mm (8 x 20 Watt) Gestängehöhe 250 mm</p> <p>Abhängenhöhe Decke bis Unterkante Leuchte 500 mm 750 mm 1000 mm 1500 mm</p> <p>Extras</p> <ul style="list-style-type: none"> • Elektronische Vorschaltgeräte • Sonderlängen der Pendelrohrabhängung möglich • Die Leuchtstoffröhren T12, Ø 38 mm, Warmton, können mitbestellt werden <p>Sonderausführungen auf Anfrage</p>	<p>Baldachin als Drückteil gefertigt, Ø 500 mm, Höhe 120 mm</p> 	 <p>T8 T12</p>  <p>CE 230 V 50 Hz</p> <p>IP 20</p>  <p>elektrische Bauteile geprüft</p>
--	---	--	--

Materialien - Oberflächen

Stahlblech beschichtet / lackiert



Tiefschwarz
S/S



Reinweiß, RAL 9010
S/W

Sonderlackierung in RAL-Farbtönen möglich

Stahlblech natur



Klarlack matt
S/M



Klarlack glänzend
S/G

Eine schlichte einflammige Leuchte mit bewährter Standardleuchtstoffröhre. Eine der ersten Neonleuchten aus traditionell gefertigten Metallkomponenten. Durch ihre außergewöhnliche Formensprache ist sie überall dort gefragt, wo ein außergewöhnlicher Akzent zu setzen ist. In großen Räumen kommt sie ganz besonders in stringenter Reihung zur Geltung.



Lugeck I Hänger

<p>Abgebildete Leuchte: Leuchte T8, (18 Watt), Metallteile aus veredeltem Stahlblech, Rohr Ø16 mm, Tiefschwarz (S/S), 1500 mm schwarzes Textilkabel (TS), Elektrik mit verlustarmem Vorschaltgerät und Starter in Rechteckgehäuse als Deckenhalterung</p>	<p>Leuchtenlänge / Röhrenlänge (T12/T8) 900 mm / 590 mm (20/18 Watt) 1510 mm / 1200 mm (40/36 Watt) 1810 mm / 1500 mm (65/58 Watt)</p> <p>Rechteckgehäuse 500 x 60 x 35 mm (20/18 Watt) 730 x 60 x 35 mm (40/36 Watt) 730 x 60 x 35 mm (65/58 Watt)</p> <p>Extras</p> <ul style="list-style-type: none"> • Sonderlängen der Kabelabhängung möglich • mit elektronischen Vorschaltgeräten (EVGs), auch Dim.1-10 Volt oder Dali-Dim. möglich • Die Leuchtstoffröhre T12, Ø38 mm kann mitbestellt werden <p>Sonderausführungen auf Anfrage</p>	<p>Standardausführung Fassungshülse für Leuchtstoffröhre T12, Ø38 mm</p>  <p>Optional bestellbar Fassungshülse für Leuchtstoffröhre T8, Ø26 mm</p> 	 <p>T8 T12</p> <p>CE 230 V 50 Hz</p> <p> IP 20</p> <p> elektrische Bauteile geprüft</p>
--	---	---	---

Materialien - Oberflächen

Stahlblech beschichtet / lackiert



Tiefschwarz
S/S



Reinweiß, RAL 9010
S/W

Sonderlackierung in RAL-Farbtönen möglich

Stahlblech natur



Klarlack matt
S/M



Klarlack glänzend
S/G

Kabelvarianten zu den Aufhängungen



PVC-Kabel
schwarz.../PS

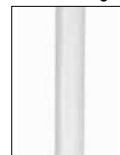

PVC-Kabel
weiß.../PW



Textil-Kabel
schwarz.../TS

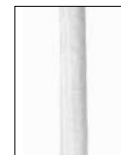

Textil-Kabel
weiß.../TW

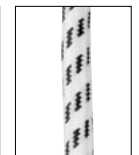

Textil-Kabel
schwarz-weiß.../TSW

Eine zweckbetonte zweiflämmige Variante mit bewährten Standardleuchtstoffröhren.
Durch das hochwertige Zahngelenk ist ihr Neigungswinkel flexibel. Durch ihre außergewöhnliche Formensprache ist sie überall dort gefragt, wo ein außergewöhnlicher Akzent zu setzen ist. In hohen Räumen kommt sie ganz besonders zur Geltung.



Lugeck Pfeil II

<p>Abgebildete Leuchte: Leuchte T12 (2 x 20 Watt), Metallteile aus veredeltem Stahlblech, Röhre Ø 16 mm, Tiefschwarz (S/S), 1300 mm Pendelrohr-abhängung Ø 16 mm, Zahngelenk vernickelt (Z/MN), Elektrik mit verlustarmem Vorschaltgerät und Starter im zylindrischen Baldachin Ø 130 mm, Höhe 200 mm</p>	<p>Leuchtenbreite / Röhrenlänge (T12/T8) 500 mm / 590 mm (2 x 20/18 Watt) Gestängehöhe 930 mm</p> <p>Abhängehöhe Decke bis Unterkante Leuchte 1300 mm 1500 mm 1750 mm 2000 mm</p> <p>Extras</p> <ul style="list-style-type: none"> • Sonderlängen der Pendelrohrabhängung möglich • mit elektronischen Vorschaltgeräten (EVGs), auch Dim.1-10 Volt oder Dali-Dim. möglich • Die Leuchtstoffröhre T12, Ø38 mm kann mitbestellt werden <p>Sonderausführungen auf Anfrage</p>	<p>Baldachin bei Dim.1-10 Volt oder Dali-Dim. Halbrundbaldachin Ø 400 mm, Höhe 80 mm</p>  <p>Optional bestellbar Fassungshülse für Leuchtstoffröhre T8, Ø 26 mm</p> 	 <p>T8 T12</p> <p>CE 230 V 50 Hz</p> <p> IP 20</p> <p>  elektrische Bauteile geprüft</p>
--	--	--	--

Materialien - Oberflächen

Stahlblech beschichtet / lackiert



Tiefschwarz
S/S



Reinweiß, RAL 9010
S/W

Sonderlackierung in RAL-Farbtönen möglich

Stahlblech natur



Klarlack matt
S/M



Klarlack glänzend
S/G

Zahngelenk



Messing poliert
Z/MP



Messing vernickelt
Z/MN

Eine zweckbetonte vierflammige Variante mit bewährten Standardleuchtstoffröhren.

Eine der ersten Neonleuchten aus traditionell gefertigten Metallkomponenten. Durch ihre außergewöhnliche Formensprache ist sie überall dort gefragt, wo ein außergewöhnlicher Akzent zu setzen ist. In hohen Räumen kommt sie ganz besonders zur Geltung.



Lugeck Pfeil IV

<p>Abgebildete Leuchte: Leuchte T12 (4 x 20 Watt), Metallteile aus veredeltem Stahlblech, Röhre Ø 16 mm, Tiefschwarz (S/S), 1250 mm Pendelrohr-abhängung Ø 16 mm, Elektrik mit verlustarmem Vorschaltgerät und Starter im Halbrundbaldachin Ø 400 mm, Höhe 80 mm</p>	<p>Leuchten-Ø / Röhrenlänge (T12/T8) 500 mm / 590 mm (4 x 20/18 Watt) Gestängehöhe 1080 mm</p> <p>Abhängehöhe Decke bis Unterkante Leuchte 1250 mm 1500 mm 1750 mm 2000 mm</p> <p>Extras</p> <ul style="list-style-type: none"> • Sonderlängen der Pendelrohrabhängung möglich • mit elektronischen Vorschaltgeräten (EVGs), auch Dim.1-10 Volt oder Dali-Dim. möglich • Die Leuchtstoffröhre T12, Ø38 mm kann mitbestellt werden <p>Sonderausführungen auf Anfrage</p>	<p>Baldachin bei allen Vorschaltgeräten Halbrundbaldachin Ø 400 mm, Höhe 80 mm</p>  <p>Optional bestellbar Fassungshülse für Leuchtstoffröhre T8, Ø 26 mm</p> 	  <p>T8 T12</p> <p>CE 230 V 50 Hz</p> <p> IP 20</p> <p>  elektrische Bauteile geprüft</p>
---	---	--	---

Materialien - Oberflächen

Stahlblech beschichtet / lackiert



Tiefschwarz
S/S



Reinweiß, RAL 9010
S/W

Sonderlackierung in RAL-Farbtönen möglich

Stahlblech natur



Klarlack matt
S/M



Klarlack glänzend
S/G

Eine zweckbetonte achtflammige Variante mit bewährten Standardleuchtstoffröhren.

Eine der ersten Neonleuchten aus traditionell gefertigten Metallkomponenten. Durch ihre außergewöhnliche Formensprache ist sie überall dort gefragt, wo ein außergewöhnlicher Akzent zu setzen ist. In hohen Räumen kommt sie ganz besonders zur Geltung.



Lugeck Pfeil VIII

<p>Abgebildete Leuchte: Leuchte T8 (8 x 18 Watt), Metallteile aus veredeltem Stahlblech, Röhre Ø 16 mm, Tiefschwarz (S/S), 1250 mm Pendelrohr-abhängung Ø 25 mm, Elektrik mit verlustarmem Vorschaltgerät und Starter im Halbrundbaldachin Ø 400 mm, Höhe 80 mm</p>	<p>Leuchten-Ø / Röhrenlänge (T12/T8) 500 mm / 590 mm (8 x 18/20 Watt) Gestängehöhe 1080 mm</p> <p>Abhängehöhe Decke bis Unterkante Leuchte 1250 mm 1500 mm 1750 mm 2000 mm</p> <p>Extras</p> <ul style="list-style-type: none"> • Sonderlängen der Pendelrohrabhängung möglich • mit elektronischen Vorschaltgeräten (EVGs), auch Dim.1-10 Volt oder Dali-Dim. möglich • Die Leuchtstoffröhre T12, Ø38 mm kann mitbestellt werden <p>Sonderausführungen auf Anfrage</p>	<p>Baldachin bei allen Vorschaltgeräten Halbrundbaldachin Ø 400 mm, Höhe 80 mm</p>  <p>Standard bestellbar Fassungshülse für Leuchtstoffröhre T12, Ø38 mm</p> 	 <p>T8 T12</p>  <p>CE 230 V 50 Hz</p> <p>IP 20</p> <p>elektrische Bauteile geprüft</p>
--	---	--	--

Materialien - Oberflächen

Stahlblech beschichtet / lackiert



Tiefschwarz
S/S



Reinweiß, RAL 9010
S/W

Sonderlackierung in RAL-Farbtönen möglich

Stahlblech natur



Klarlack matt
S/M



Klarlack glänzend
S/G

Die Leuchte mit ihrer vollkommenen Kugelform aus opalem Echglas gehört bis heute zu den oft kopierten Klassikern der Leuchtenwelt. Aus traditionell gefertigten Drückteilen und hochwertigem Glas. Durch ihre klare, zeitlose Form eignet sie sich besonders zur stilvollen Ausleuchtung sowohl privater als auch öffentlicher Räume.



Inzersdorf

<p>Abgebildete Leuchte: Kugel-Ø350 mm, verchromt (S/C), 1000 mm Pendelrohrabhängung Ø 16 mm (PR), mit Baldachin Ø 100 mm</p> <p>Mit hochwertiger Porzellanfassung E27, für Glühlampen bis max. 100 Watt</p>	<p>Durchmesser 250 mm 300 mm 350 mm 400 mm</p> <p>Pendelrohrlänge (ohne Kugel) 500 mm 1000 mm 1500 mm</p> <p>Kabelabhängung 1500 mm</p> <p>Extras • Sonderlängen des Pendelrohrs auf Wunsch</p> <p>Sonderausführungen auf Anfrage</p>	<p>Lieferung bei allen Aufhängungen komplett mit klassischem Baldachin</p> 	 E27  E27  230 V 50 Hz  IP 20  elektrische Bauteile geprüft
--	---	---	--

Materialien - Oberflächen

Stahlblech beschichtet / lackiert



Tiefschwarz
S/S



Reinweiß, RAL 9010
S/W

Sonderlackierung in RAL-Farbtönen möglich

Stahlblech natur



Klarlack matt
S/M



Klarlack glänzend
S/G

Stahlblech verchromt



verchromt
S/C

Aufhängungen



Pendelrohr
PR/...



PVC-Kabel mit
Stahlseele
PKS/...

Kabelvarianten zu den Aufhängungen



PVC-Kabel
schwarz.../PS



PVC-Kabel
weiß.../PW

Die tropfenförmige Leuchte besteht durch ihr zweigeteiltes opales Glas, welche mittels eines Doppelrings verbunden werden.

Aus traditionell gefertigten Drückteilen, hochwertigem Glas sowie handgefertigtem Verbindungsring aus Metall. Mit ihrer eleganten Form und den Metallbeschlägen eignet sie sich als stilsichere Ergänzung sowohl in privaten als auch in öffentlichen, repräsentativen Räumlichkeiten.



Heiligenstadt II

<p>Abgebildete Leuchte: Metallteile verchromt (S/C), 1000 mm Pendelrohrabhangung Ø10 mm (PR), mit Baldachin Ø115 mm</p> <p>Mit hochwertiger Porzellanfassung E27, für Glühlampen bis max. 100 Watt</p>	<p>Leuchten-Ø / Leuchtenhöhe 260 mm / 310 mm</p> <p>Pendelrohrlänge (ohne Leuchte) 500 mm 1000 mm 1500 mm</p> <p>Kabelabhangung 1500 mm</p> <p>Extras • Sonderlängen des Pendelrohrs auf Wunsch</p> <p>Sonderausführungen auf Anfrage</p>	<p>Lieferung bei allen Aufhängungen komplett mit klassischem Baldachin in gewellter Kegelform</p> 	 E27  E27  230 V 50 Hz  IP 20   elektrische Bauteile geprüft
---	---	--	---

Materialien - Oberflächen

Stahlblech beschichtet / lackiert



Tiefschwarz
S/S



Reinweiß, RAL 9010
S/W

Sonderlackierung in RAL-Farbtönen möglich

Messing natur



ohne Lackierung
M/R

Stahlblech natur



Klarlack matt
S/M



Klarlack glänzend
S/G

Stahlblech verchromt



verchromt
S/C

Kupfer mit Patina



Patina
K/P

Aufhängungen



Pendelrohr
PR/...



PVC-Kabel mit
Stahlseele
PKS/...

Kabelvarianten zu den Aufhängungen



PVC-Kabel
schwarz.../PS



PVC-Kabel
weiß.../PW

Die tropfenförmige Leuchte besteht durch die stilsichere Kombination von opalem und ätzmattem Glas. Aus traditionell gefertigten Druckteilen, hochwertigem Glas sowie handgefertigtem Verbindungsring aus Metall. Mit ihrer eleganten Form und den Metallbeschlägen eignet sie sich als stilsichere Ergänzung sowohl in privaten als auch in öffentlichen, repräsentativen Räumlichkeiten.



Heiligenstadt

<p>Abgebildete Leuchte: Metallteile verchromt (S/C), 1000 mm Pendelrohrabhangung Ø16 mm (PR), mit Baldachin Ø115 mm</p> <p>Mit hochwertiger Porzellanfassung E27, für Glühlampen bis max. 100 Watt</p>	<p>Leuchten-Ø / Leuchtenhöhe 330 mm / 340 mm</p> <p>Pendelrohrlänge (ohne Leuchte) 500 mm 1000 mm 1500 mm</p> <p>Kabelabhangung 1500 mm</p> <p>Extras • Sonderlängen des Pendelrohrs auf Wunsch</p> <p>Sonderausführungen auf Anfrage</p>	<p>Lieferung bei allen Aufhängungen komplett mit klassischem Baldachin in gewellter Kegelform</p> 	  <p>E27 E27</p> <p>CE 230 V 50 Hz</p>  <p>IP 20</p>  <p>elektrische Bauteile geprüft</p>
---	---	--	---

Materialien - Oberflächen

Stahlblech beschichtet / lackiert

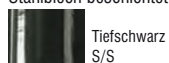

Sonderlackierung in RAL-Farbtönen möglich

Messing natur



Stahlblech natur

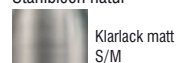

Stahlblech verchromt



Kupfer mit Patina

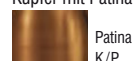

Aufhängungen



Pendelrohr
PR/...



PVC-Kabel mit
Stahlseele
PKS/...

Kabelvarianten zu den Aufhängungen



PVC-Kabel
schwarz.../PS



PVC-Kabel
weiß.../PW

Die formschöne Leuchte mit Halbkugel-Reflektor und runder Kuppel zeigt eindrucksvoll, was in der handwerklichen Formtechnik möglich ist. Aus traditionell gefertigten Druckteilen sowie einzelnen Porzellanelementen. Das reiche Wechselspiel von Halbkugel-, Zylinder- und Kegelelementen macht die Leuchte zu einem typischen Vertreter des jungen 20. Jahrhunderts.



Murau Aufbau gerade

<p>Abgebildete Leuchte: Reflektor-Ø 315 mm, aus veredeltem Stahlblech, außen Tiefschwarz (S/S), innen Reinweiß, Alu-Gussaufhängung mit vernickelter Kette (AGK), schwarzes Textil-Kabel (TS) 1,5 m lang, mit Metall-Baldachin Halbkugel Ø 80 mm</p> <p>Mit hochwertiger Porzellanfassung E27, für Glühlampen bis max. 100 Watt</p>	<p>Reflektor-Ø / Leuchtenhöhe 315 mm / 220 mm</p> <p>Sonderausführungen auf Anfrage</p>	<p>Lieferung bei allen Aufhängungen komplett mit klassischem Baldachin</p> 	 E27  E27  230 V 50 Hz  IP 20  elektrische Bauteile geprüft
---	--	---	--

Materialien - Oberflächen

Stahlblech beschichtet / lackiert

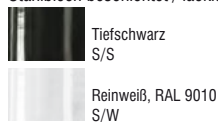

Sonderlackierung in RAL-Farbtönen möglich

Aluminium natur

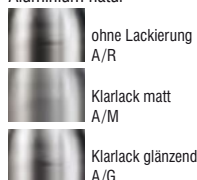

Stahlblech natur



Kupfer natur



Aufhängungen: Kabel/Kupferkette

Aufhängungen



Kabel-Aufhängung K/...

Alu-Gussaufhängung mit vernickelter Kette AGK/...

Alu-Gussaufhängung mit Stahlseil AGS/...

Alu-Kabel-Box mit vernickelter Kette ABK/...

Alu-Kabel-Box mit Seilaufhänger ABS

Kabelvarianten zu den Aufhängungen

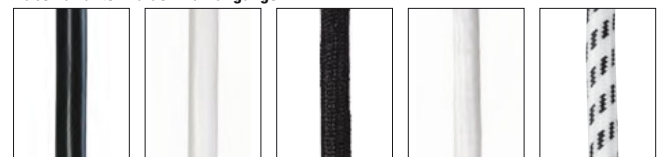

PVC-Kabel schwarz.../PS

PVC-Kabel weiß.../PW

Textil-Kabel schwarz.../TS

Textil-Kabel weiß.../TW

Textil-Kabel schwarz-weiß.../TSW

Die formschöne Leuchte mit schrägem Reflektor, der nahtlos in eine Halbkugel übergeht.
Aus traditionell gefertigten Drückteilen sowie einzelnen Porzellanelementen.
Der Wechsel von schräg zu rund in einer Einheit gefertigt ist eine Besonderheit in der handwerklichen Druckkunst.

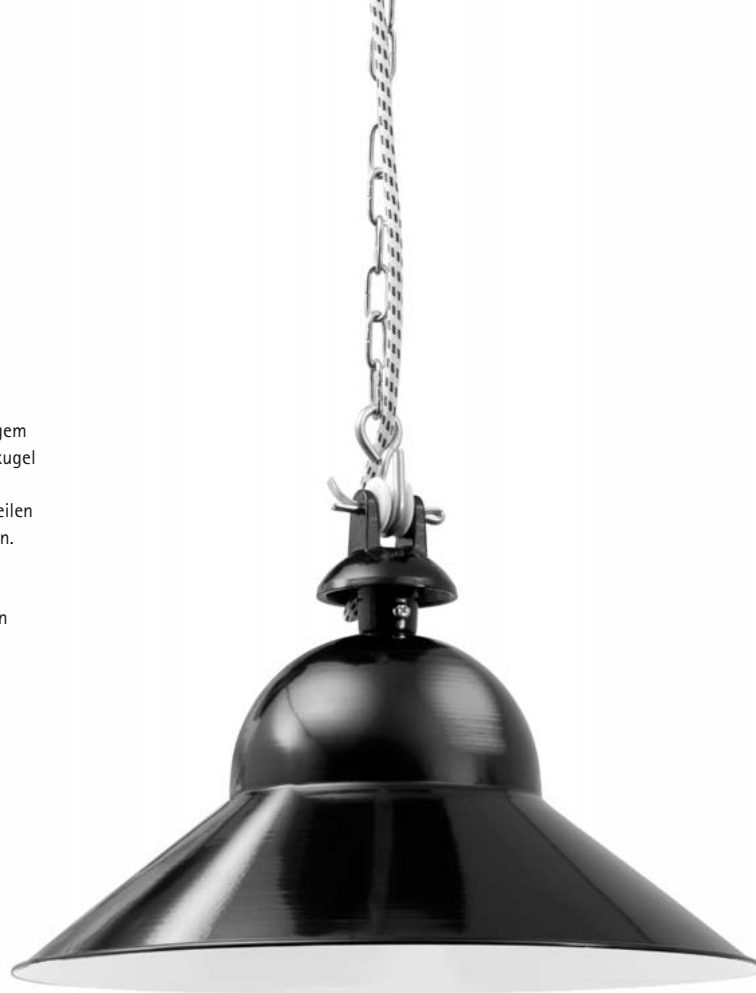

Murau kurz

<p>Abgebildete Leuchte: Reflektor-Ø 315 mm, aus veredeltem Stahlblech, außen Tiefschwarz (S/S), innen Reinweiß, Alu-Gussaufhängung mit vernickelter Kette (AGK), schwarz-weißes Textil-Kabel (TSW) 1,5 m lang, mit Metall-Baldachin Halbkugel Ø 80 mm</p> <p>Mit hochwertiger Porzellanfassung E27, für Glühlampen bis max. 100 Watt</p>	<p>Reflektor-Ø / Leuchtenhöhe 315 mm / 150 mm</p>	<p>Lieferung bei allen Aufhängungen komplett mit klassischem Baldachin</p> 	 E27  E27  230 V 50 Hz  IP 20   elektrische Bauteile geprüft
Sonderausführungen auf Anfrage			

Materialien - Oberflächen

Stahlblech beschichtet / lackiert



Tiefschwarz
S/S



Reinweiß, RAL 9010
S/W

Sonderlackierung in RAL-Farbtönen möglich

Aluminium natur



ohne Lackierung
A/R



Klarlack matt
A/M



Klarlack glänzend
A/G

Stahlblech natur



Klarlack matt
S/M



Klarlack glänzend
S/G

Kupfer natur



ohne Lackierung
K/R



Klarlack matt
K/M



Klarlack glänzend
K/G

Aufhängungen: Kabel/Kupferkette

Aufhängungen



Kabel-Aufhängung
K/...



Alu-Gussaufhängung
mit vernickelter Kette
AGK/...



Alu-Gussaufhängung
mit Stahlseil
AGS/...



Alu-Kabel-Box
mit vernickelter Kette
ABK/...



Alu-Kabel-Box
mit Seilaufhänger
ABS

Kabelvarianten zu den Aufhängungen



PVC-Kabel
schwarz.../PS



PVC-Kabel
weiß.../PW



Textil-Kabel
schwarz.../TS



Textil-Kabel
weiß.../TW

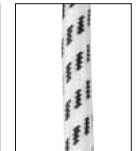

Textil-Kabel
schwarz-weiß.../TSW

Eine kraftvolle Leuchte mit rundlichem Schirm und Breitzylinder-Glas.
 Aus traditionell gefertigten Guss- und Drückteilen sowie einzelnen Porzellanelementen. Der harmonische Übergang vom weichen Schirm zum geschwungenen Ansatz des Breitzylinder-Glases verleiht ihr ein stimmiges Äußeres.



Wels Breitzylinder

<p>Abgebildete Leuchte: Reflektor-Ø 450 mm, aus veredeltem Stahlblech, außen Tiefschwarz (S/S), innen Reinweiß, mit klarem Breitzylinder-Glas, Alu-Gussaufhängung mit vernickelter Kette (AGK), schwarz-weißes Textil-Kabel (TSW) 1,5 m lang, mit Metall-Baldachin Halbkugel Ø 80 mm</p> <p>Mit hochwertiger Porzellanfassung E27, für Glühlampen bis max. 100 Watt</p>	<p>Reflektor-Ø / Leuchtenhöhe mit Glas 450 mm / 370 mm</p> <p>Glas-Ø / Glashöhe 260 mm / 200mm</p> <p>Extras • Breitzylinder-Glas auch opalen lieferbar</p> <p>Sonderausführungen auf Anfrage</p>	<p>Lieferung bei allen Aufhängungen komplett mit klassischem Baldachin</p> 	  <p>E27 E27</p> <p>CE 230 V 50 Hz</p> <p> IP 20</p> <p> elektrische Bauteile geprüft</p>
---	---	---	--

Materialien - Oberflächen

Stahlblech beschichtet / lackiert



Sonderlackierung in RAL-Farbtönen möglich

Aluminium natur

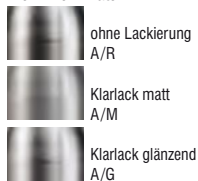

Stahlblech natur



Kupfer natur



Aufhängungen: Kabel/Kupferkette

Aufhängungen



Kabel-Aufhängung K/... Alu-Gussaufhängung mit vernickelter Kette AGK/... Alu-Gussaufhängung mit Stahlschlüssel AGS/... Alu-Kabel-Box mit vernickelter Kette ABK/... Alu-Kabel-Box mit Seilaufhänger ABS

Kabelvarianten zu den Aufhängungen

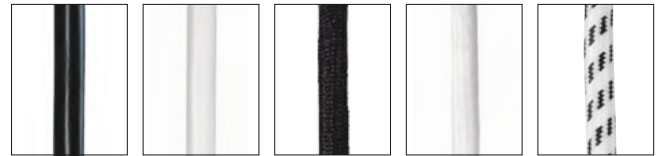

PVC-Kabel schwarz.../PS PVC-Kabel weiß.../PW Textil-Kabel schwarz.../TS Textil-Kabel weiß.../TW Textil-Kabel schwarz-weiß.../TSW

Eine elegante Leuchte mit rundlichem Schirm und opalem Kugelglas.
 Aus traditionell gefertigten Guss- und Drückteilen sowie einzelnen Porzellanelementen. Das Spiel der Rundungen von Schirm und Kugelglas verleiht der Leuchte ihr unverkennbares Äußeres.



Wels Kugel

<p>Abgebildete Leuchte: Reflektor-Ø 350 mm, aus veredeltem Stahlblech, außen Tiefschwarz (S/S), innen Reinweiß, mit opalem Kugelglas. Alu-Gussaufhängung mit vernickelter Kette (AGK), schwarz-weißes Textil-Kabel (TSW) 1,5 m lang, mit Metall-Baldachin Halbkugel Ø 80 mm</p> <p>Mit hochwertiger Porzellanfassung E27, für Glühlampen bis max. 100 Watt</p>	<p>Reflektor-Ø / Leuchtenhöhe mit Glas 350 mm / 270 mm 450 mm / 310 mm</p> <p>Glas-Ø / Glashöhe 180 mm / 180 mm (max. 100 Watt) 215 mm / 215 mm (max. 200 Watt)</p> <p>Sonderausführungen auf Anfrage</p>	<p>Lieferung bei allen Aufhängungen komplett mit klassischem Baldachin</p>	<p>E27 E27</p> <p>CE 230 V 50 Hz</p> <p>IP 20</p> <p>elektrische Bauteile geprüft</p>
---	---	--	---

Materialien - Oberflächen

Stahlblech beschichtet / lackiert



Sonderlackierung in RAL-Farbtönen möglich

Aluminium natur

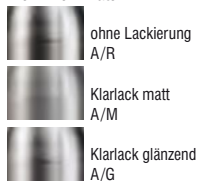

Stahlblech natur



Kupfer natur



Aufhängungen: Kabel/Kupferkette

Aufhängungen



Kabel-Aufhängung K/...
 Alu-Gussaufhängung mit vernickelter Kette AGK/...
 Alu-Gussaufhängung mit Stahlschlüssel AGS/...
 Alu-Kabel-Box mit vernickelter Kette ABK/...
 Alu-Kabel-Box mit Seilaufhänger ABS

Kabelvarianten zu den Aufhängungen

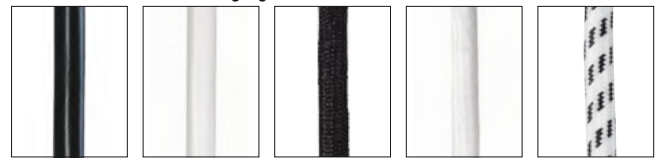

PVC-Kabel schwarz.../PS
 PVC-Kabel weiß.../PW
 Textil-Kabel schwarz.../TS
 Textil-Kabel weiß.../TW
 Textil-Kabel schwarz-weiß.../TSW

Eine vornehme Leuchte mit rundlichem Schirm und Spitzzylinder-Glas.
Aus traditionell gefertigten Guss- und Drückteilen sowie einzelnen Porzellanelementen. Besonders der Kontrast zwischen der weichen Form des Schirms und dem kantigeren Spitzzylinder-Glas verleiht ihr das außergewöhnliche Äußere.



Wels Spitzzylinder

<p>Abgebildete Leuchte: Reflektor-Ø 450 mm, aus veredeltem Stahlblech, außen Tiefschwarz (S/S), innen Reinweiß, mit opalem Spitzzylinder-Glas, Alu-Gussaufhängung mit vernickelter Kette (AGK), schwarz-weißes Textil-Kabel (TSW) 1,5 m lang, mit Metall-Baldachin Halbkugel Ø 80 mm</p> <p>Mit hochwertiger Porzellanfassung E27, für Glühlampen bis max. 100 Watt</p>	<p>Reflektor-Ø / Leuchtenhöhe mit Glas 450 mm / 410 mm</p> <p>Glas-Ø / Glashöhe 220 mm / 240 mm</p> <p>Extras • Spitzzylinder-Glas auch in Klar erhältlich</p> <p>Sonderausführungen auf Anfrage</p>	<p>Lieferung bei allen Aufhängungen komplett mit klassischem Baldachin</p> 	  <p>E27 E27</p> <p>CE 230 V 50 Hz</p> <p> IP 20</p> <p> elektrische Bauteile geprüft</p>
--	---	---	---

Materialien - Oberflächen

Stahlblech beschichtet / lackiert



Tiefschwarz
S/S



Reinweiß, RAL 9010
S/W

Sonderlackierung in RAL-Farbtönen möglich

Aluminium natur



ohne Lackierung
A/R



Klarlack matt
A/M



Klarlack glänzend
A/G

Stahlblech natur



Klarlack matt
S/M



Klarlack glänzend
S/G

Kupfer natur



ohne Lackierung
K/R



Klarlack matt
K/M



Klarlack glänzend
K/G

Aufhängungen: Kabel/Kupferkette

Aufhängungen



Kabel-Aufhängung
K/...



Alu-Gussaufhängung
mit vernickelter Kette
AGK/...



Alu-Gussaufhängung
mit Stahlschl
AGS/...



Alu-Kabel-Box
mit vernickelter Kette
ABK/...



Alu-Kabel-Box
mit Seilaufhänger
ABS

Kabelvarianten zu den Aufhängungen



PVC-Kabel
schwarz.../PS



PVC-Kabel
weiß.../PW



Textil-Kabel
schwarz.../TS



Textil-Kabel
weiß.../TW



Textil-Kabel
schwarz-weiß.../TSW

Die formschöne Leuchte mit Halbkugel-Schirm und runder Kuppel zeichnet sich aus durch ausdrucksstarke Formen und homogene Oberflächen.
 Aus traditionell gefertigten Drückteilen sowie einzelnen Porzellanelementen. Wie bei vielen ihrer Geschwister erlaubt ihr zeitloses Design einen besonders vielseitigen Einsatz.



Spittelberg

<p>Abgebildete Leuchte: Reflektor-Ø 350 mm, aus veredeltem Stahlblech, außen Tiefschwarz (S/S), innen Reinweiß, schwarz-weißes Textil-Kabel (TSW) 1,5 m lang, mit Metall-Baldachin Halbkugel Ø 80 mm</p> <p>Mit hochwertiger Porzellanfassung E27, für Glühlampen bis max. 100 Watt</p>	<p>Reflektor-Ø / Leuchtenhöhe 300 mm / 180 mm 350 mm / 210 mm 400 mm / 250 mm</p> <p>Sonderausführungen auf Anfrage</p>	<p>Lieferung bei allen Aufhängungen komplett mit klassischem Baldachin</p>	<p>E27</p> <p>E27</p> <p>CE 230 V 50 Hz</p> <p>IP 20</p> <p> elektrische Bauteile geprüft</p>
---	---	--	---

Materialien - Oberflächen

Stahlblech beschichtet / lackiert

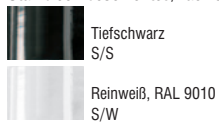

Sonderlackierung in RAL-Farbtönen möglich

Aluminium natur

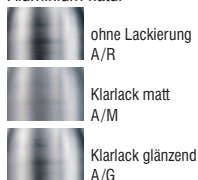

Stahlblech natur



Kupfer natur



Aufhängungen: Kabel/Kupferkette

Aufhängungen



Kabel-Aufhängung K/...
 Alu-Gussaufhängung mit vernickelter Kette AGK/...
 Alu-Gussaufhängung mit Stahlseil AGS/...
 Alu-Kabel-Box mit vernickelter Kette ABK/...
 Alu-Kabel-Box mit Seilaufhänger ABS

Kabelvarianten zu den Aufhängungen

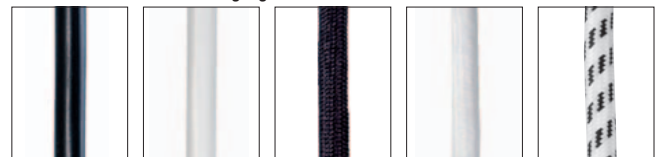

PVC-Kabel schwarz.../PS
 PVC-Kabel weiß.../PW
 Textil-Kabel schwarz.../TS
 Textil-Kabel weiß.../TW
 Textil-Kabel schwarz-weiß.../TSW

Eine elegante Leuchte mit flachem Schirm und opalenem Schraubglas in Kugelform.

Aus traditionell gefertigten Guss- und Drückteilen. Die eigenwillige Schichtung der in der Drück- und Sicken-technik gearbeiteten Kubatur, verleiht ihr ein besonders extravagantes Äußeres.



Salzburg Kugel

<p>Abgebildete Leuchte: Reflektor-Ø 350 mm, aus veredeltem Stahlblech, außen Tiefschwarz (S/S), innen Reinweiß, opalenes Kugelglas, Alu-Gussaufhängung mit vernickelter Kette (AGK), schwarzes Textil-Kabel (TS) 1,5 m lang, mit Metall-Baldachin Halbkugel Ø 80 mm</p> <p>Mit hochwertiger Porzellanfassung E27, für Glühlampen bis max. 100 Watt</p>	<p>Reflektor-Ø / Leuchtenhöhe mit Glas 300 mm / 320 mm 350 mm / 320 mm 400 mm / 320 mm</p> <p>Glas-Ø / Glashöhe 180 mm / 180 mm</p> <p>Sonderausführungen auf Anfrage</p>	<p>Lieferung bei allen Aufhängungen komplett mit klassischem Baldachin</p> 	 E27  E27  230 V 50 Hz  IP 20  elektrische Bauteile geprüft
---	---	---	---

Materialien - Oberflächen

Stahlblech beschichtet / lackiert



Tiefschwarz
S/S



Reinweiß, RAL 9010
S/W

Sonderlackierung in RAL-Farbtönen möglich

Aluminium natur



ohne Lackierung
A/R



Klarlack matt
A/M



Klarlack glänzend
A/G

Stahlblech natur



Klarlack matt
S/M



Klarlack glänzend
S/G

Kupfer natur



ohne Lackierung
K/R



Klarlack matt
K/M



Klarlack glänzend
K/G

Aufhängungen: Kabel/Kupferkette

Aufhängungen



Kabel-Aufhängung
K/...



Alu-Gussaufhängung
mit vernickelter Kette
AGK/...



Alu-Gussaufhängung
mit Stahlschl
AGS/...



Alu-Kabel-Box
mit vernickelter Kette
ABK/...



Alu-Kabel-Box
mit Seilaufhänger
ABS

Kabelvarianten zu den Aufhängungen



PVC-Kabel



PVC-Kabel



Textil-Kabel



Textil-Kabel



Textil-Kabel

Eine verspielt gearbeitete Leuchte mit flachem Schirm und opalemem Ring-Glas.
 Aus traditionell gefertigten Guss- und Drückteilen sowie einzelnen Porzellanelementen. Die eigenwillige Schichtung der in der Drück- und Sicketechnik gearbeiteten Kubatur verleiht ihr ein besonders extravagantes Äußeres.





Salzburg Ring

<p>Abgebildete Leuchte: Reflektor-Ø 300 mm, aus veredeltem Stahlblech, außen Tiefschwarz (S/S), innen Reinweiß, opales Glas, Alu-Gussaufhängung mit vernickelter Kette (AGK), schwarzes Textil-Kabel (TS) 1,5 m lang, mit Metall-Baldachin Halbkugel Ø 80 mm</p> <p>Mit hochwertiger Porzellanfassung E27, für Glühlampen bis max. 100 Watt</p>	<p>Reflektor-Ø / Leuchtenhöhe mit Glas 300 mm / 300 mm 350 mm / 300 mm 400 mm / 300 mm</p> <p>Glas-Ø / Glashöhe 230 mm / 155 mm</p> <p>Sonderausführungen auf Anfrage</p>	<p>Lieferung bei allen Aufhängungen komplett mit klassischem Baldachin</p> 	 E27  E27  230 V 50 Hz  IP 20   elektrische Bauteile geprüft
---	---	---	---



Materialien - Oberflächen

Stahlblech beschichtet / lackiert

-  Tiefschwarz S/S
-  Reinweiß, RAL 9010 S/W

Sonderlackierung in RAL-Farbtönen möglich

Aluminium natur

-  ohne Lackierung A/R
-  Klarlack matt A/M
-  Klarlack glänzend A/G

Stahlblech natur

-  Klarlack matt S/M
-  Klarlack glänzend S/G

Kupfer natur





-  ohne Lackierung K/R
-  Klarlack matt K/M
-  Klarlack glänzend K/G

Aufhängungen: Kabel/Kupferkette

Aufhängungen

-  Kabel-Aufhängung K/...
-  Alu-Gussaufhängung mit vernickelter Kette AGK/...
-  Alu-Gussaufhängung mit Stahlseil AGS/...
-  Alu-Kabel-Box mit vernickelter Kette ABK/...
-  Alu-Kabel-Box mit Seilaufhänger ABS

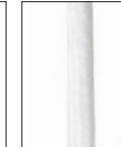
Kabelvarianten zu den Aufhängungen

-  PVC-Kabel schwarz.../PS
-  PVC-Kabel weiß.../PW
-  Textil-Kabel schwarz.../TS
-  Textil-Kabel weiß.../TW
-  Textil-Kabel schwarz-weiß.../TSW

Eine verspielt gearbeitete Leuchte mit zwei flachen Schirmen mit opalenen Ring-Gläsern und Pendelrohrabhangung. Aus traditionell gefertigten Guss- und Druckteilen sowie einzelnen Porzellanelementen. Die eigenwillige Schichtung der in der Druck- und Sicken-technik gearbeiteten Kubatur verleiht ihr ein besonders extravagantes Aueres.



Salzburg Ring II

<p>Abgebildete Leuchte: Reflektoren-Ø 300 mm, aus veredeltem Stahlblech, außen Tiefschwarz (S/S), innen Reinwei, opalene Glaser, 1000 mm Pendelrohrabhangung Ø 16 mm, Pendelarmbreite 800 mm (PB0800), Gesamtbreite 1100 mm, mit Metall-Baldachin Halbkugel Ø 100 mm</p> <p>Mit hochwertiger Porzellanfassung E27, fur Gluhlampen bis max. 100 Watt</p>	<p>Reflektor-Ø / Leuchtenhohe mit Glas 300 mm / 300 mm 350 mm / 300 mm 400 mm / 300 mm</p> <p>Glas-Ø / Glashohe 230 mm / 155 mm</p> <p>Abhangehohe Decke bis Unterkante Leuchte 650 mm 1000 mm 750 mm 1500 mm</p> <p>Extras • Sonderlanglen der Pendelrohrabhangung moglich</p> <p>Sonderausfuhungen auf Anfrage</p>	<p>Lieferung komplett mit klassischem Baldachin</p> 	<table border="1"> <tr> <td> E27</td> <td> E27</td> </tr> <tr> <td></td> <td>230 V 50 Hz</td> </tr> <tr> <td></td> <td>IP 20</td> </tr> <tr> <td colspan="2">  elektrische Bauteile gepruft</td> </tr> </table>	 E27	 E27		230 V 50 Hz		IP 20	  elektrische Bauteile gepruft	
 E27	 E27										
	230 V 50 Hz										
	IP 20										
  elektrische Bauteile gepruft											



Materialien - Oberflachen

Stahlblech beschichtet / lackiert

-  Tiefschwarz S/S
-  Reinwei, RAL 9010 S/W

Sonderlackierung in RAL-Farbtonen moglich

Aluminium natur

-  ohne Lackierung A/R
-  Klarlack matt A/M
-  Klarlack glanzend A/G

Stahlblech natur

-  Klarlack matt S/M
-  Klarlack glanzend S/G

Kupfer natur

-  ohne Lackierung K/R
-  Klarlack matt K/M
-  Klarlack glanzend K/G

Mittelflansch: RAL (nach Wunsch)

Breite Best.-Nr. Wandarmausfuhungen

- 800 mm PW0800
- 1000 mm PW1000
- 1200 mm PW1200



Pendelarm waagrecht, mit Zahngelenk

Zahngelenk



Messing poliert Z/MP

Messing vernickelt Z/MN

Messing verkupfert Z/MK

800 mm PB0800



Pendelarm geschwungen

Eine verspielt gearbeitete Leuchte mit flachem Schirm und opalem Spitzzylinder-Glas.
Aus traditionell gefertigten Guss- und Drückteilen sowie einzelnen Porzellanelementen. Die eigenwillige Schichtung der in der Drück- und Sicketechnik gearbeiteten Kubatur, verleiht ihr ein besonders extravagantes Äußeres.



Salzburg Spitzzylinder

<p>Abgebildete Leuchte: Reflektor-Ø 300 mm, aus veredeltem Stahlblech, außen Tiefschwarz (S/S), innen Reinweiß, opalesnes Spitzzylinder-Glas, Alu-Gussaufhängung mit vernickelter Kette (AGK), schwarzes Textil-Kabel (TS) 1,5 m lang, mit Metall-Baldachin Halbkugel Ø 80 mm</p> <p>Mit hochwertiger Porzellanfassung E27, für Glühlampen bis max. 100 Watt</p>	<p>Reflektor-Ø / Leuchtenhöhe mit Glas 300 mm / 300 mm 350 mm / 300 mm 400 mm / 300 mm</p> <p>Glas-Ø / Glashöhe 200 mm / 170 mm</p> <p>Extras • Zylinderglas auch in Klar lieferbar</p> <p>Sonderausführungen auf Anfrage</p>	<p>Lieferung bei allen Aufhängungen komplett mit klassischem Baldachin</p> 	 E27  E27  230 V 50 Hz  IP 20   elektrische Bauteile geprüft
---	--	---	---

Materialien - Oberflächen

Stahlblech beschichtet / lackiert



Tiefschwarz
S/S



Reinweiß, RAL 9010
S/W

Sonderlackierung in RAL-Farbtönen möglich

Aluminium natur



ohne Lackierung
A/R



Klarlack matt
A/M



Klarlack glänzend
A/G

Stahlblech natur



Klarlack matt
S/M



Klarlack glänzend
S/G

Kupfer natur



ohne Lackierung
K/R



Klarlack matt
K/M



Klarlack glänzend
K/G

Aufhängungen: Kabel/Kupferkette

Aufhängungen



Kabel-Aufhängung
K/...



Alu-Gussaufhängung
mit vernickelter Kette
AGK/...



Alu-Gussaufhängung
mit Stahlseil
AGS/...



Alu-Kabel-Box
mit vernickelter Kette
ABK/...



Alu-Kabel-Box
mit Seilaufhänger
ABS

Kabelvarianten zu den Aufhängungen



PVC-Kabel



PVC-Kabel



Textil-Kabel



Textil-Kabel







Textil-Kabel

Die Leuchte gehört mit der prägnanten Form des gleichwinkligen Kegelreflektors zu den unverwechselbaren Klassikern. Auch im Aufbau besticht sie durch Kompromisslosigkeit: Sichtbar ist nur der gedrückte Schirm – die Porzellanfassung und das Leuchtmittel treten zurück. Dabei verstärken die durch den Fertigungsprozess bedingten sichtbaren Spuren im Metall den eigenständigen Charakter der Leuchte.



Tuchlauben

<p>Abgebildete Leuchte: Reflektor-Ø 400 mm, aus Aluminium natur, allseits mit Klarlack matt geschützt (A/M), schwarzes PVC-Kabel (PS) 1,5 m lang, mit Metall-Baldachin in Kegelform Ø 100 mm</p> <p>Mit hochwertiger Porzellanfassung E27, für Glühlampen bis max. 100 Watt</p>	<p>Reflektor-Ø / Leuchtenhöhe</p> <table border="0"> <tr><td>200 mm</td><td>/ 150 mm</td></tr> <tr><td>250 mm</td><td>/ 190 mm</td></tr> <tr><td>300 mm</td><td>/ 235 mm</td></tr> <tr><td>350 mm</td><td>/ 280 mm</td></tr> <tr><td>400 mm</td><td>/ 320 mm</td></tr> </table> <p>Haupttypen</p> <p>Sonderausführungen auf Anfrage</p>	200 mm	/ 150 mm	250 mm	/ 190 mm	300 mm	/ 235 mm	350 mm	/ 280 mm	400 mm	/ 320 mm	<p>Lieferung bei allen Aufhängungen komplett mit Baldachin in Kegelform</p> 	  <p>E27 E27</p> <p>CE 230 V 50 Hz</p>  <p>IP 20</p>  <p>elektrische Bauteile geprüft</p>
200 mm	/ 150 mm												
250 mm	/ 190 mm												
300 mm	/ 235 mm												
350 mm	/ 280 mm												
400 mm	/ 320 mm												

Materialien - Oberflächen

Stahlblech beschichtet / lackiert

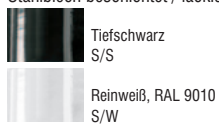

Sonderlackierung in RAL-Farbtönen möglich

Aluminium natur

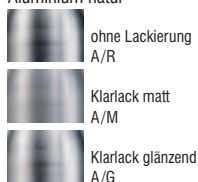

Stahlblech natur



Kupfer natur



Aufhängungen: Kabel/Kupferkette

Aufhängungen



Kabel-Aufhängung K/...

Alu-Gussaufhängung mit vernickelter Kette AGK/...

Alu-Gussaufhängung mit Stahlseil AGS/...

Alu-Kabel-Box mit vernickelter Kette ABK/...

Alu-Kabel-Box mit Seilaufhänger ABS

Kabelvarianten zu den Aufhängungen

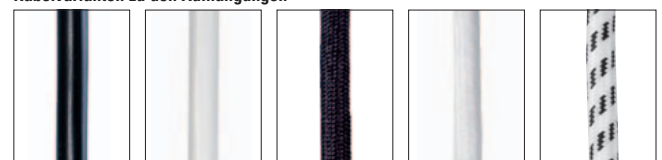

PVC-Kabel schwarz.../PS

PVC-Kabel weiß.../PW

Textil-Kabel schwarz.../TS

Textil-Kabel weiß.../TW

Textil-Kabel schwarz-weiß.../TSW



Wandleuchten



Eine klassische Leuchte mit Reflektor in abgeflachter Kegelform und Wandarm.

Aus traditionell gefertigten Guss- und Drückteilen sowie einzelnen Porzellanelementen. Sie zeichnet sich aus durch ihr zeitloses Design und ihre besonders breit gefächerten Einsatzmöglichkeiten.

Sievering Wand

<p>Abgebildete Leuchte: Reflektor-Ø 400 mm, aus hochwertigem rostfreiem Aluminium, außen Tiefschwarz (A/S), innen Reinweiß, komplett mit Alu-Wandarm Doppelrohr senkrecht 400 mm (W340), in die Alu-Gussrosette anschlussfertig verdrahtet</p> <p>Mit hochwertiger Porzellanfassung E27, für Glühlampen bis max. 100 Watt</p>	<p>Reflektor-Ø / Leuchtenhöhe ohne Wandarm</p> <table border="0"> <tr><td>■ 250 mm</td><td>/ 190 mm</td></tr> <tr><td>■ 300 mm</td><td>/ 210 mm</td></tr> <tr><td>■ 350 mm</td><td>/ 240 mm</td></tr> <tr><td>■ 400 mm</td><td>/ 280 mm</td></tr> <tr><td>450 mm</td><td>/ 330 mm</td></tr> <tr><td>500 mm</td><td>/ 350 mm</td></tr> <tr><td>600 mm</td><td>/ 365 mm</td></tr> </table> <p>■ Haupttypen</p> <p>Extras</p> <ul style="list-style-type: none"> • Schutzkorb aus Stahldraht, verzinkt, Ø 300 mm, Ø 400 mm, Ø 500 mm • E40 für Glühlampen bis 1000 Watt bei Ø 500 mm, Ø 600 mm <p>Sonderausführungen auf Anfrage</p>	■ 250 mm	/ 190 mm	■ 300 mm	/ 210 mm	■ 350 mm	/ 240 mm	■ 400 mm	/ 280 mm	450 mm	/ 330 mm	500 mm	/ 350 mm	600 mm	/ 365 mm	<p>Einrohrige Alu-Wandarme auch als Ecktype möglich (Best.-Nr. + Eck)</p>  <p>Rosette der Kupfer-Varianten</p> 	<table border="1"> <tr> <td> E27</td> <td> E27</td> </tr> <tr> <td> E40</td> <td> E40</td> </tr> <tr> <td> 230 V 50 Hz</td> <td> IP 20</td> </tr> <tr> <td></td> <td> Außenbereich</td> </tr> <tr> <td colspan="2"> elektrische Bauteile geprüft</td> </tr> </table>	 E27	 E27	 E40	 E40	 230 V 50 Hz	 IP 20		 Außenbereich	 elektrische Bauteile geprüft	
■ 250 mm	/ 190 mm																										
■ 300 mm	/ 210 mm																										
■ 350 mm	/ 240 mm																										
■ 400 mm	/ 280 mm																										
450 mm	/ 330 mm																										
500 mm	/ 350 mm																										
600 mm	/ 365 mm																										
 E27	 E27																										
 E40	 E40																										
 230 V 50 Hz	 IP 20																										
	 Außenbereich																										
 elektrische Bauteile geprüft																											

Materialien - Oberflächen

Aluminium beschichtet / lackiert

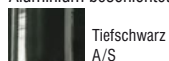

Sonderlackierung in RAL-Farbtönen möglich

Aluminium natur

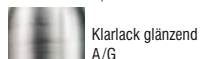
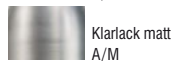

Kupfer natur

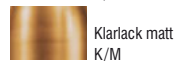

Länge Best.-Nr. Wandarmausführungen

300 mm	W330
350 mm	W335
■ 400 mm	W340
■ 450 mm	W345
■ 500 mm	W350
600 mm	W360
700 mm	W370



■ 300 mm	W130
■ 350 mm	W135
■ 400 mm	W140
■ 450 mm	W145
■ 500 mm	W150
600 mm	W160
700 mm	W170



■ 370 mm	W1600
----------	-------

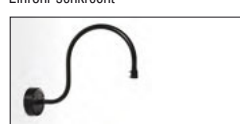

■ Haupttypen



Eine geschlossene Leuchte mit Reflektor in abgeflachter Kegelform, Verschluss aus klarem Glas und Wandarm.

Aus traditionell gefertigten Guss- und Drückteilen sowie einzelnen Porzellanelementen. Sie zeichnet sich aus durch ihr zeitloses Design und ihre besonders breit gefächerten Einsatzmöglichkeiten. Der Glasverschluss verleiht der Leuchte eine besonders kompakte Optik und schafft ein angenehm diffuses Licht.

Sievering Glas Wand

<p>Abgebildete Leuchte: Reflektor-Ø 315 mm, aus hochwertigem rostfreiem Aluminium, außen Tiefschwarz (A/S), innen Reinweiß, mit klarer Glasabdeckung, komplett mit Alu-Wandarm Doppelrohr senkrecht 400 mm (W340), in die Alu-Gussrosette anschlussfertig verdrahtet</p> <p>Mit hochwertiger Porzellanfassung E27, für Glühlampen bis max. 100 Watt</p>	<p>Reflektor-Ø / Leuchtenhöhe ohne Wandarm 315 mm / 270 mm 415 mm / 375 mm</p> <p>Glas-Ø 300 mm 400 mm</p> <p>Extras • Schutzkorb aus Stahldraht, verzinkt, Ø 350 mm, Ø 450 mm</p> <p>Sonderausführungen auf Anfrage</p>	<p>Einrohrige Alu-Wandarme auch als Ecktype möglich (Best.-Nr. + Eck)</p> <p>Rosette der Kupfer-Varianten</p>	 E27  E27  230 V 50 Hz  IP 20  Außenbereich   elektrische Bauteile geprüft
--	---	---	---

Materialien - Oberflächen

Aluminium beschichtet / lackiert

 Tiefschwarz
A/S

 Reinweiß, RAL 9010
A/W

Sonderlackierung in RAL-Farbtönen möglich

Aluminium natur

 ohne Lackierung
A/R

 Klarlack matt
A/M

 Klarlack glänzend
A/G

Kupfer natur

 ohne Lackierung
K/R

 Klarlack matt
K/M

 Klarlack glänzend
K/G

Länge Best.-Nr. Wandarmausführungen

300 mm W330
350 mm W335
400 mm W340
450 mm W345
500 mm W350
600 mm W360
700 mm W370



300 mm W130
350 mm W135
400 mm W140
450 mm W145
500 mm W150
600 mm W160
700 mm W170



370 mm W1600









■ Haupttypen



Eine klassische Leuchte mit Reflektor in abgeflachter Kegelform plus opalem Schraubglas in Kugelform und Wandarm.

Aus traditionell gefertigten Guss- und Drückteilen sowie einzelnen Porzellanelementen. Sie zeichnet sich aus durch ihr zeitloses Design und ist mit eingebautem Gusskopf mit Dichtung und Schraubglas spritzwassergeschützt.

Sievering Kugel Wand

<p>Abgebildete Leuchte: Reflektor-Ø 450 mm, aus hochwertigem rostfreiem Aluminium, außen Tiefschwarz (A/S), innen Reinweiß, opales Kugelglas bis 100 Watt, komplett mit Alu-Wandarm Doppelrohr senkrecht 400 mm (W340), in die Alu-Gussrosette anschlussfertig verdrahtet</p> <p>Mit hochwertiger Porzellanfassung E27, für Glühlampen bis max. 60/100 Watt</p>	<p>Reflektor-Ø / -höhe mit Glas 350 mm / 285 mm (max. 60 Watt) 400 mm / 305 mm (max. 60 Watt) 450 mm / 360 mm (max. 100 Watt) 500 mm / 360 mm (max. 100 Watt) 600 mm / 365 mm (max. 100 Watt)</p> <p>Glas-Ø 160 mm (max. 60 Watt) 180 mm (max. 100 Watt)</p> <p>Sonderausführungen auf Anfrage</p>	<p>Einrohrige Alu-Wandarme auch als Ecktype möglich (Best.-Nr. + Eck)</p> 	 E27  E27
		<p>Rosette der Kupfer-Varianten</p> 	 230 V 50 Hz  IP 54 Außenbereich  elektrische Bauteile geprüft

Materialien - Oberflächen

Aluminium beschichtet / lackiert

 Tiefschwarz A/S

 Reinweiß, RAL 9010 A/W

Sonderlackierung in RAL-Farbtönen möglich

Aluminium natur

 ohne Lackierung A/R

 Klarlack matt A/M

 Klarlack glänzend A/G

Kupfer natur

 ohne Lackierung K/R

 Klarlack matt K/M

 Klarlack glänzend K/G

Länge Best.-Nr. Wandarmausführungen

300 mm W330
350 mm W335
400 mm W340
450 mm W345
500 mm W350
600 mm W360
700 mm W370



300 mm W130
350 mm W135
400 mm W140
450 mm W145
500 mm W150
600 mm W160
700 mm W170



370 mm W1600

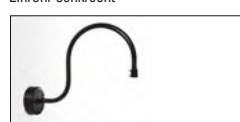



■ Haupttypen



Eine klassische Leuchte mit Reflektor in abgeflachter Kegelform plus Schraubglas in Zylinderform und Wandarm.

Aus traditionell gefertigten Guss- und Drückteilen sowie einzelnen Porzellanelementen. Sie zeichnet sich aus durch ihr zeitloses Design und ist mit eingebautem Gusskopf mit Dichtung und Schraubglas spritzwassergeschützt.

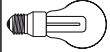
Sievering Zylinder Wand

<p>Abgebildete Leuchte: Reflektor-Ø 450 mm, aus hochwertigem rostfreiem Aluminium, außen Tiefschwarz (A/S), innen Reinweiß, klares Zylinderglas bis 100 Watt, komplett mit Alu-Wandarm Doppelrohr senkrecht 400 mm (W340), in die Alu-Gussrosette anschlussfertig verdrahtet</p> <p>Mit hochwertiger Porzellanfassung E27, für Glühlampen bis max. 60/100 Watt</p>	<p>Reflektor-Ø / -höhe mit Glas 350 mm / 285 mm (max. 60 Watt) 400 mm / 305 mm (max. 60 Watt) 450 mm / 360 mm (max. 100 Watt) 500 mm / 360 mm (max. 100 Watt) 600 mm / 365 mm (max. 100 Watt)</p> <p>Glas-Ø 100 mm (max. 60 Watt) 110 mm (max. 100 Watt)</p> <p>Extras • Zylinderglas auch in Matt lieferbar</p> <p>Sonderausführungen auf Anfrage</p>	<p>Einrohrige Alu-Wandarme auch als Ecktype möglich (Best.-Nr. + Eck)</p> <p>Rosette der Kupfer-Varianten</p>	 E27  E27  230 V 50 Hz  IP 54 Außenbereich   elektrische Bauteile geprüft
---	---	---	---

Materialien - Oberflächen

Aluminium beschichtet / lackiert

 Tiefschwarz
A/S

 Reinweiß, RAL 9010
A/W

Sonderlackierung in RAL-Farbtönen möglich

Aluminium natur

 ohne Lackierung
A/R

 Klarlack matt
A/M

 Klarlack glänzend
A/G

Kupfer natur

 ohne Lackierung
K/R

 Klarlack matt
K/M

 Klarlack glänzend
K/G

Länge Best.-Nr. Wandarmausführungen

300 mm W330
350 mm W335
400 mm W340
450 mm W345
500 mm W350
600 mm W360
700 mm W370



Doppelrohr senkrecht (nur Aluminium)

300 mm W130
350 mm W135
400 mm W140
450 mm W145
500 mm W150
600 mm W160
700 mm W170



Einrohr senkrecht

370 mm W1600

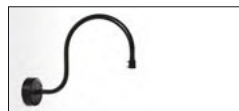

Einrohr geschwungen groß

■ Haupttypen



Eine zurückhaltende Leuchte in doppelter Kegelform und Wandarm. Aus traditionell gefertigten Guss- und Drückteilen sowie einzelnen Porzellanelementen. Ihre reduzierte, klare Form verleiht ihr eine zeitlose Wirkung und erlaubt den Einsatz in unterschiedlichsten Bereichen.

Passau Wand

<p>Abgebildete Leuchte: Reflektor-Ø 350 mm, aus hochwertigem rostfreiem Aluminium, außen Tiefschwarz (A/S), innen Reinweiß, komplett mit Alu-Wandarm Doppelrohr senkrecht 400 mm (W340), in die Alu-Gussrosette anschlussfertig verdrahtet</p> <p>Mit hochwertiger Porzellanfassung E27, für Glühlampen bis max. 100 Watt</p>	<p>Reflektor-Ø / Leuchtenhöhe ohne Wandarm 350 mm / 230 mm 450 mm / 300 mm</p> <p>Sonderausführungen auf Anfrage</p>	<p>Einrohrige Alu-Wandarme auch als Ecktype möglich (Best.-Nr. + Eck)</p>  <p>Rosette der Kupfer-Varianten</p> 	 E27  E27  230 V 50 Hz  IP 20 Außenbereich   elektrische Bauteile geprüft
--	---	---	---

Materialien - Oberflächen

Aluminium beschichtet / lackiert

 Tiefschwarz
A/S

 Reinweiß, RAL 9010
A/W

Sonderlackierung in RAL-Farbtönen möglich

Aluminium natur

 ohne Lackierung
A/R

 Klarlack matt
A/M

 Klarlack glänzend
A/G

Kupfer natur

 ohne Lackierung
K/R

 Klarlack matt
K/M

 Klarlack glänzend
K/G

Länge Best.-Nr. Wandarmausführungen

300 mm W330
350 mm W335
400 mm W340
450 mm W345
500 mm W350
600 mm W360
700 mm W370



300 mm W130
350 mm W135
400 mm W140
450 mm W145
500 mm W150
600 mm W160
700 mm W170



370 mm W1600



■ Haupttypen



Diese klassische Leuchte wird in einer Einheit als Fassungsdom mit gerundetem Übergang zum bauchigen Reflektor nahtlos auf einer Form gedrückt.

Eine Reflektorleuchte mit zeitlosen Rundungen in einer besonderen Formensprache.

Baden Wand

<p>Abgebildete Leuchte: Reflektor-Ø 400 mm, aus hochwertigem rostfreiem Aluminium, außen Tiefschwarz (A/S), innen Reinweiß, komplett mit Alu-Wandarm Doppelrohr senkrecht 400 mm (W340), in die Alu-Gussrosette anschlussfertig verdrahtet</p> <p>Mit hochwertiger Porzellanfassung E27, für Glühlampen bis max. 100 Watt</p>	<p>Reflektor-Ø / Leuchtenhöhe ohne Wandarm 300 mm / 200 mm 400 mm / 320 mm</p>	<p>Einrohrige Alu-Wandarme auch als Ecktype möglich (Best.-Nr. + Eck)</p> 	 E27  E27  230 V 50 Hz  IP 20 Außenbereich   elektrische Bauteile geprüft
--	---	--	---

Sonderausführungen auf Anfrage

Materialien - Oberflächen

Aluminium beschichtet / lackiert



Tiefschwarz
A/S



Reinweiß, RAL 9010
A/W

Sonderlackierung in RAL-Farbtönen möglich

Aluminium natur



ohne Lackierung
A/R



Klarlack matt
A/M



Klarlack glänzend
A/G

Länge Best.-Nr. Wandarmausführungen

300 mm	W330
350 mm	W335
400 mm	W340
450 mm	W345
500 mm	W350
600 mm	W360
700 mm	W370



Doppelrohr senkrecht (nur Aluminium)

300 mm	W130
350 mm	W135
400 mm	W140
450 mm	W145
500 mm	W150
600 mm	W160
700 mm	W170



Einrohr senkrecht

370 mm	W1600
--------	-------

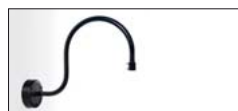









Einrohr geschwungen groß

■ Haupttypen



Die optisch auf das Wesentliche reduzierte Leuchte mit flachem Reflektor und runder Kuppel besticht durch ihre elegante Klarheit. Aus traditionell gefertigten Druckteilen sowie hochwertigen Porzellanelementen. Die reduzierte Form macht sie zu einem Klassiker.

Josefstadt Wand

<p>Abgebildete Leuchte: Reflektor-Ø 350 mm, aus hochwertigem rostfreiem Aluminium, außen Tiefschwarz (A/S), innen Reinweiß, komplett mit Alu-Wandarm Einrohr schräg 400 mm (W240), in die Alu-Gussrosette anschlussfertig verdrahtet</p> <p>Mit hochwertiger Porzellanfassung E27, für Glühlampen bis max. 100 Watt</p>	<p>Reflektor-Ø / Reflektorhöhe</p> <p>160 mm / 92 mm 200 mm / 105 mm 250 mm / 108 mm 300 mm / 111 mm 350 mm / 116 mm 400 mm / 127 mm</p> <p>Sonderausführungen auf Anfrage</p>	<p>Einrohrige Alu-Wandarme auch als Ecktype möglich (Best.-Nr.+Eck)</p>  <p>Rosette der Kupfer-Varianten</p> 	 E27  E27  230 V 50 Hz  IP 20   elektrische Bauteile geprüft
--	---	--	---

Materialien - Oberflächen

Aluminium beschichtet / lackiert

Tiefschwarz
A/S

Reinweiß, RAL 9010
A/W

Sonderlackierung in RAL-Farbtönen möglich

Aluminium natur

ohne Lackierung
A/R

Klarlack matt
A/M

Klarlack glänzend
A/G

Kupfer natur

ohne Lackierung
K/R

Klarlack matt
K/M

Klarlack glänzend
K/G

Länge Best.-Nr. Wandarmausführungen

300 mm W130
350 mm W135
400 mm W140
450 mm W145
500 mm W150
600 mm W160
700 mm W170



Einrohr senkrecht



Einrohr geschwungen groß

Haupttypen

Länge Best.-Nr. Wandarmausführungen

300 mm W230
350 mm W235
400 mm W240
450 mm W245
500 mm W250
600 mm W260
700 mm W270



Einrohr schräg









Einrohr geschwungen klein

Haupttypen



Die zeitlose Leuchte mit kegel-
förmigem Schirm und runder Kuppel
besticht durch ihre klassische Eleganz.
Aus traditionell gefertigten
Drückteilen sowie hochwertigen
Porzellanelementen. Die klare Form
macht sie zu einem zeitlosen Klassiker.

Währing Wand

<p>Abgebildete Leuchte: Reflektor-Ø 240 mm, aus hochwertigem rostfreiem Aluminium, außen Tiefschwarz (A/S), innen Reinweiß, komplett mit Alu-Wandarm Einrohr schräg 400 mm (W240), in die Alu-Gussrosette anschlussfertig verdrahtet</p> <p>Mit hochwertiger Porzellanfassung E27, für Glühlampen bis max. 100 Watt</p>	<p>Reflektor-Ø / Reflektorhöhe 160 mm / 116 mm 200 mm / 129 mm 240 mm / 145 mm</p> <p>Sonderausführungen auf Anfrage</p>	<p>Einrohrige Alu-Wandarme auch als Ecktype möglich (Best.-Nr. + Eck)</p> 	 E27  E27
		<p>Rosette der Kupfer-Varianten</p> 	<p>CE 230 V 50 Hz</p> <p>IP 20</p> <p>  elektrische Bauteile geprüft</p>

Materialien - Oberflächen

Aluminium beschichtet / lackiert

 Tiefschwarz
A/S

 Reinweiß, RAL 9010
A/W

Sonderlackierung in RAL-Farbtönen möglich

Aluminium natur

 ohne Lackierung
A/R

 Klarlack matt
A/M

 Klarlack glänzend
A/G

Kupfer natur

 ohne Lackierung
K/R

 Klarlack matt
K/M

 Klarlack glänzend
K/G

Länge Best.-Nr. Wandarmausführungen

■ 300 mm W130
■ 350 mm W135
■ 400 mm W140
■ 450 mm W145
■ 500 mm W150
■ 600 mm W160
■ 700 mm W170



Einrohr senkrecht

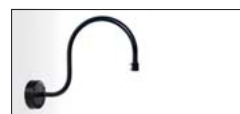

Einrohr geschwungen groß

■ Haupttypen

Länge Best.-Nr. Wandarmausführungen

■ 300 mm W230
■ 350 mm W235
■ 400 mm W240
■ 450 mm W245
■ 500 mm W250
■ 600 mm W260
■ 700 mm W270



Einrohr schräg



Einrohr geschwungen klein







■ Haupttypen



Die konstruktiv und optisch auf das Wesentliche reduzierte Leuchte mit flachem Reflektor, Bügelfassung und Wandarm besticht durch ihre einfache Klarheit.

Aus traditionell gefertigten Metallteilen sowie hochwertigen Porzellanelementen. Das reizvolle Zusammenspiel von Porzellan und Metall macht sie zu einem schlichten Klassiker.

Wieden Wand

<p>Abgebildete Leuchte: Reflektor-Ø 300 mm, aus hochwertigem rostfreiem Aluminium, außen Tiefschwarz (A/S), innen Reinweiß, komplett mit Alu-Wandarm Einrohr schräg 400 mm (W240), in die Alu-Gussrosette anschlussfertig verdrahtet</p> <p>Mit hochwertiger Porzellanfassung E27, für Glühlampen bis max. 100 Watt</p>	<p>Reflektor-Ø / Reflektorhöhe</p> <table border="0"> <tr><td>160 mm</td><td>/ 22 mm</td></tr> <tr><td>200 mm</td><td>/ 35 mm</td></tr> <tr><td>250 mm</td><td>/ 38 mm</td></tr> <tr><td>300 mm</td><td>/ 41 mm</td></tr> <tr><td>350 mm</td><td>/ 46 mm</td></tr> <tr><td>400 mm</td><td>/ 57 mm</td></tr> </table> <p>Sonderausführungen auf Anfrage</p>	160 mm	/ 22 mm	200 mm	/ 35 mm	250 mm	/ 38 mm	300 mm	/ 41 mm	350 mm	/ 46 mm	400 mm	/ 57 mm	<p>Einrohrige Alu-Wandarme auch als Ecktype möglich (Best.-Nr. + Eck)</p>  <p>Rosette der Kupfer-Varianten</p> 	  <p>E27 E27</p> <p>CE 230 V 50 Hz</p> <p> IP 20</p> <p>  elektrische Bauteile geprüft</p>
160 mm	/ 22 mm														
200 mm	/ 35 mm														
250 mm	/ 38 mm														
300 mm	/ 41 mm														
350 mm	/ 46 mm														
400 mm	/ 57 mm														

Materialien - Oberflächen

Aluminium beschichtet / lackiert

Tiefschwarz
A/S

Reinweiß, RAL 9010
A/W

Sonderlackierung in RAL-Farbtönen möglich

Aluminium natur

ohne Lackierung
A/R

Klarlack matt
A/M

Klarlack glänzend
A/G

Kupfer natur

ohne Lackierung
K/R

Klarlack matt
K/M

Klarlack glänzend
K/G

Länge Best.-Nr. Wandarmausführungen

■ 300 mm	W130
■ 350 mm	W135
■ 400 mm	W140
■ 450 mm	W145
■ 500 mm	W150
■ 600 mm	W160
■ 700 mm	W170

■ 370 mm W1600

■ Haupttypen



Einrohr senkrecht

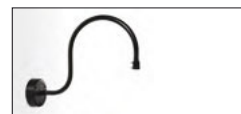

Einrohr geschwungen groß

Länge Best.-Nr. Wandarmausführungen

■ 300 mm	W230
■ 350 mm	W235
■ 400 mm	W240
■ 450 mm	W245
■ 500 mm	W250
■ 600 mm	W260
■ 700 mm	W270

■ 220 mm W1500

■ Haupttypen



Einrohr schräg









Einrohr geschwungen klein



Eine zeitlose Leuchte mit kegel-
förmigem Schirm, Porzellanfassung
und Wandarm.

Aus traditionell gefertigten
Drückteilen sowie hochwertigen
Porzellanelementen. Besonders in der
tiefschwarzen Variante besticht sie
durch ihre Klarheit in Form und Farbe.

Donaustadt Wand

<p>Abgebildete Leuchte: Reflektor-Ø 240 mm, aus hochwertigem rostfreiem Aluminium, außen Tiefschwarz (A/S), innen Reinweiß, komplett mit Alu- Wandarm Einrohr schräg 400 mm (W240), in die Alu-Gussrosette anschlussfertig verdrahtet</p> <p>Mit hochwertiger Porzellanfassung E27, für Glühlampen bis max. 100 Watt</p>	<p>Reflektor-Ø / Reflektorhöhe 160 mm / 54 mm 200 mm / 67 mm 240 mm / 83 mm</p>	<p>Einrohrige Alu-Wandarme auch als Ecktype möglich (Best.-Nr. + Eck)</p>  <p>Rosette der Kupfer-Varianten</p> 	  <p>E27 E27</p> <p>CE 230 V 50 Hz</p> <p> IP 20</p> <p>  elektrische Bauteile geprüft</p>
Sonderausführungen auf Anfrage			

Materialien - Oberflächen

Aluminium beschichtet / lackiert



Tiefschwarz
A/S



Reinweiß, RAL 9010
A/W

Sonderlackierung in RAL-Farbtönen möglich

Aluminium natur



ohne Lackierung
A/R



Klarlack matt
A/M



Klarlack glänzend
A/G

Kupfer natur



ohne Lackierung
K/R



Klarlack matt
K/M



Klarlack glänzend
K/G

Länge Best.-Nr. Wandarmausführungen

■ 300 mm	W130
■ 350 mm	W135
■ 400 mm	W140
■ 450 mm	W145
■ 500 mm	W150
■ 600 mm	W160
■ 700 mm	W170



Einrohr senkrecht

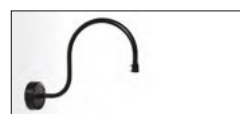

Einrohr geschwungen groß

■ Haupttypen

Länge Best.-Nr. Wandarmausführungen

■ 300 mm	W230
■ 350 mm	W235
■ 400 mm	W240
■ 450 mm	W245
■ 500 mm	W250
■ 600 mm	W260
■ 700 mm	W270



Einrohr schräg











Einrohr geschwungen klein

■ Haupttypen



Eine schlichte Leuchte mit gewölbtem Schirm, Porzellanfassung und Wandarm.
Aus traditionell gefertigten Drückteilen sowie hochwertigen Porzellanelementen. Besonders in der tiefschwarzen Variante besticht sie durch ihre Harmonie in Form und Farbe.

Floridsdorf Wand

<p>Abgebildete Leuchte: Reflektor-Ø 260 mm, aus hochwertigem rostfreiem Aluminium, außen Tiefschwarz (A/S), innen Reinweiß, komplett mit Alu-Wandarm Einrohr gerade 400 mm (W140), in die Alu-Gussrosette anschlussfertig verdrahtet</p> <p>Mit hochwertiger Porzellanfassung E27, für Glühlampen bis max. 100 Watt</p>	<p>Reflektor-Ø / Reflektorhöhe 200 mm / 25 mm 260 mm / 60 mm</p> <p>Sonderausführungen auf Anfrage</p>	<p>Einrohrige Alu-Wandarme auch als Ecktype möglich (Best.-Nr. + Eck)</p>  <p>Rosette der Kupfer-Varianten</p> 	 E27  E27  230 V 50 Hz  IP 20   elektrische Bauteile geprüft
--	---	---	---

Materialien - Oberflächen

Aluminium beschichtet / lackiert

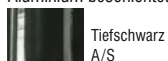

Tiefschwarz
A/S



Reinweiß, RAL 9010
A/W

Sonderlackierung in RAL-Farbtönen möglich

Aluminium natur



ohne Lackierung
A/R

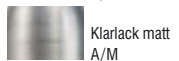

Klarlack matt
A/M

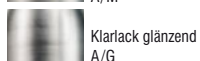

Klarlack glänzend
A/G

Kupfer natur

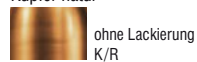

ohne Lackierung
K/R

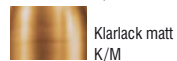

Klarlack matt
K/M

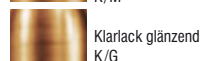

Klarlack glänzend
K/G

Länge Best.-Nr. Wandarmausführungen

■ 300 mm	W130
■ 350 mm	W135
■ 400 mm	W140
■ 450 mm	W145
■ 500 mm	W150
■ 600 mm	W160
■ 700 mm	W170



Einrohr senkrecht

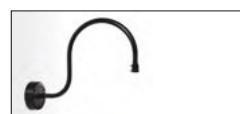

Einrohr geschwungen groß

■ Haupttypen

Länge Best.-Nr. Wandarmausführungen

■ 300 mm	W230
■ 350 mm	W235
■ 400 mm	W240
■ 450 mm	W245
■ 500 mm	W250
■ 600 mm	W260
■ 700 mm	W270



Einrohr schräg



Einrohr geschwungen klein

■ Haupttypen

Eine universelle Leuchte mit Gelenk, flachem Reflektor und opalem Schraubglas in Kugelform. Aus traditionell gefertigten Guss- und Drückteilen sowie einzelnen Porzellanelementen. Durch das hochwertige Zahngelenk ist ihr Neigungswinkel flexibel. Dort, wo noch Wert auf klassische Details gelegt wird, ist sie nicht wegzudenken.



Krems Kugel Gelenk Wand

<p>Abgebildete Leuchte: Reflektor-Ø 300 mm, aus hochwertigem rostfreiem Aluminium, außen Tiefschwarz (A/S), innen Reinweiß, opales Kugelglas bis 60 Watt, vernickeltes Zahngelenk, in die Alu-Gussrossette anschlussfertig verdrahtet</p> <p>Mit hochwertiger Porzellanfassung E27, für Glühlampen bis max. 60/100 Watt</p>	<p>Reflektor-Ø 250 mm 300 mm 350 mm 400 mm</p> <p>Glas-Ø / Leuchtenhöhe mit Rosette 160 mm / 295 mm (max. 60 Watt) 180 mm / 325 mm (max. 100 Watt)</p> <p>Sonderausführungen auf Anfrage</p>	<p>Auch als Ecktype möglich (Best.-Nr. +Eck)</p>  <p>Rosette der Kupfer-Varianten</p> 	 E27  E27  230 V 50 Hz  IP 20 überdächter Außenbereich   elektrische Bauteile geprüft
--	--	---	--

Materialien - Oberflächen

Aluminium beschichtet / lackiert



Tiefschwarz
A/S



Reinweiß, RAL 9010
A/W

Sonderlackierung in RAL-Farbtönen möglich

Aluminium natur



ohne Lackierung
A/R



Klarlack matt
A/M



Klarlack glänzend
A/G

Kupfer natur



ohne Lackierung
K/R



Klarlack matt
K/M



Klarlack glänzend
K/G

Zahngelenk



Messing poliert
Z/MP



Messing vernickelt
Z/MN

Eine universelle Leuchte mit flachem Reflektor, opalem Schraubglas in Kugelform und Wandarm.
 Aus traditionell gefertigten Guss- und Drückteilen sowie einzelnen Porzellanelementen. Dort, wo noch Wert auf klassische Details gelegt wird, ist sie nicht wegzudenken.





Krems Kugel Wand

<p>Abgebildete Leuchte: Reflektor-Ø 300 mm, aus hochwertigem rostfreiem Aluminium, außen Tiefschwarz (A/S), innen Reinweiß, opales Kugelglas bis 60 Watt, komplett mit Alu-Wandarm Einrohr geschwungen 370 mm (W1600), in die Alu-Gussrosette anschlussfertig verdrahtet</p> <p>Mit hochwertiger Porzellanfassung E27, für Glühlampen bis max. 60/100 Watt</p>	<p>Reflektor-Ø 250 mm 300 mm 350 mm 400 mm</p> <p>Glas-Ø / Leuchtenhöhe ohne Wandarm 160 mm / 200 mm (max. 60 Watt) 180 mm / 230 mm (max. 100 Watt)</p> <p>Sonderausführungen auf Anfrage</p>	<p>Einrohrige Alu-Wandarme auch als Ecktype möglich (Best.-Nr. + Eck)</p>  <p>Rosette der Kupfer-Varianten</p> 	 E27  E27  230 V 50 Hz  IP 54 Außenbereich   elektrische Bauteile geprüft
--	---	--	---



Materialien - Oberflächen

Aluminium beschichtet / lackiert

-  Tiefschwarz A/S
-  Reinweiß, RAL 9010 A/W

Sonderlackierung in RAL-Farbtönen möglich

Aluminium natur

-  ohne Lackierung A/R
-  Klarlack matt A/M
-  Klarlack glänzend A/G

Kupfer natur

-  ohne Lackierung K/R
-  Klarlack matt K/M
-  Klarlack glänzend K/G

Länge Best.-Nr. Wandarmausführungen

- 300 mm W330
- 350 mm W335
- 400 mm W340
- 450 mm W345
- 500 mm W350
- 600 mm W360
- 700 mm W370



- 300 mm W130
- 350 mm W135
- 400 mm W140
- 450 mm W145
- 500 mm W150
- 600 mm W160
- 700 mm W170

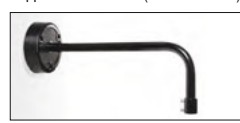

- 370 mm W1600

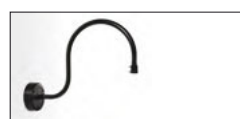

■ Haupttypen

Länge Best.-Nr. Wandarmausführungen

- 300 mm W430
- 350 mm W435
- 400 mm W440
- 450 mm W445
- 500 mm W450
- 600 mm W460
- 700 mm W470

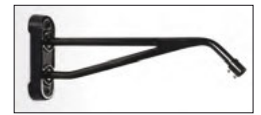

- 300 mm W230
- 350 mm W235
- 400 mm W240
- 450 mm W245
- 500 mm W250
- 600 mm W260
- 700 mm W270

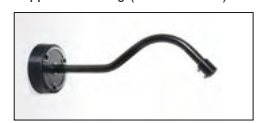

- 220 mm W1500



■ Haupttypen

Eine robuste Leuchte mit Gelenk, flachem Reflektor und Schraubglas in Zylinderform.

Aus traditionell gefertigten Guss- und Drückteilen sowie einzelnen Porzellanelementen. Durch das hochwertige Zahngelenk ist ihr Neigungswinkel flexibel. Dort, wo noch Wert auf stimmige Details gelegt wird, ist sie nicht wegzudenken.



Krems Zylinder Gelenk Wand

<p>Abgebildete Leuchte: Reflektor-Ø 350 mm, aus hochwertigem rostfreiem Aluminium, außen Tiefschwarz (A/S), innen Reinweiß, klares Zylinderglas bis 100 Watt, vernickeltes Zahngelenk, in die Alu-Gussrossette anschlussfertig verdrahtet</p> <p>Mit hochwertiger Porzellanfassung E27, für Glühlampen bis max. 60/100 Watt</p>	<p>Reflektor-Ø 250 mm 300 mm 350 mm 400 mm</p> <p>Glas-Ø / Leuchtenhöhe mit Rosette 100 mm / 295 mm (max. 60 Watt) 110 mm / 325 mm (max. 100 Watt)</p> <p>Extras • Zylinderglas auch in Matt lieferbar</p> <p>Sonderausführungen auf Anfrage</p>	<p>Auch als Ecktype möglich (Best.-Nr. +Eck)</p>  <p>Rosette der Kupfer-Varianten</p> 	 E27  E27  230 V 50 Hz  IP 20 überdächter Außenbereich   elektrische Bauteile geprüft
--	---	---	---

Materialien - Oberflächen

Aluminium beschichtet / lackiert

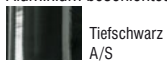

Tiefschwarz
A/S



Reinweiß, RAL 9010
A/W

Sonderlackierung in RAL-Farbtönen möglich

Aluminium natur



ohne Lackierung
A/R



Klarlack matt
A/M



Klarlack glänzend
A/G

Kupfer natur

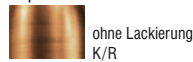

ohne Lackierung
K/R

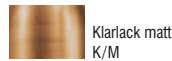

Klarlack matt
K/M



Klarlack glänzend
K/G

Zahngelenk



Messing poliert
Z/MP



Messing vernickelt
Z/MN

Eine robuste Leuchte mit flachem Reflektor, Schraubglas in Zylinderform und Wandarm.
 Aus traditionell gefertigten Guss- und Drückteilen sowie einzelnen Porzellanelementen. Dort, wo noch Wert auf stimmige Details gelegt wird, ist sie nicht wegzudenken.



Krems Zylinder Wand

<p>Abgebildete Leuchte: Reflektor-Ø 250 mm, aus hochwertigem rostfreiem Aluminium, außen Tiefschwarz (A/S), innen Reinweiß, mattiertes Zylinder- glas bis 60 Watt, komplett mit Alu-Wand- arm Einrohr geschwungen 220 mm (W1500), in die Alu-Gussrosette an- schlussfertig verdrahtet</p> <p>Mit hochwertiger Porzellanfassung E27, für Glühlampen bis max. 60/100 Watt</p>	<p>Reflektor-Ø 250 mm 300 mm 350 mm 400 mm</p> <p>Glas-Ø / Leuchtenhöhe ohne Wandarm 100 mm / 200 mm (max. 60 Watt) 110 mm / 230 mm (max. 100 Watt)</p> <p>Extras • Zylinderglas auch in Klar lieferbar</p> <p>Sonderausführungen auf Anfrage</p>	<p>Einrohrige Alu-Wandarme auch als Ecktype möglich (Best.-Nr.+Eck)</p> 	  <p>E27 E27</p>
		<p>Rosette der Kupfer-Varianten</p> 	<p>CE 230 V 50 Hz</p> <p> IP 54 Außen- bereich</p> <p>  elektrische Bauteile geprüft</p>

Materialien - Oberflächen

Aluminium beschichtet / lackiert

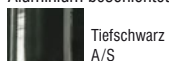

Tiefschwarz
A/S



Reinweiß, RAL 9010
A/W

Sonderlackierung in RAL-Farbtönen möglich

Aluminium natur



ohne Lackierung
A/R

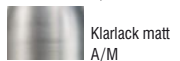

Klarlack matt
A/M

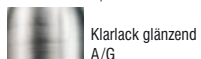

Klarlack glänzend
A/G

Kupfer natur



ohne Lackierung
K/R

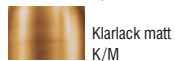

Klarlack matt
K/M



Klarlack glänzend
K/G

Länge Best.-Nr. Wandarmausführungen

300 mm	W330
350 mm	W335
400 mm	W340
450 mm	W345
500 mm	W350
600 mm	W360
700 mm	W370



Doppelrohr senkrecht (nur Aluminium)

300 mm	W130
350 mm	W135
400 mm	W140
450 mm	W145
500 mm	W150
600 mm	W160
700 mm	W170



Einrohr senkrecht

370 mm	W1600
--------	-------

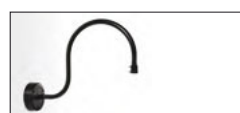

Einrohr geschwungen groß

■ Haupttypen

Länge Best.-Nr. Wandarmausführungen

300 mm	W430
350 mm	W435
400 mm	W440
450 mm	W445
500 mm	W450
600 mm	W460
700 mm	W470



Doppelrohr schräg (nur Aluminium)

300 mm	W230
350 mm	W235
400 mm	W240
450 mm	W245
500 mm	W250
600 mm	W260
700 mm	W270



Einrohr schräg

220 mm	W1500
--------	-------



Einrohr geschwungen klein

■ Haupttypen



Eine harmonische Funktionsleuchte mit Gelenk, kegelförmigem Gusskopf und opalenem Schraubglas in Kugelform. Durch das hochwertige Zahngelenk ist ihr Neigungswinkel flexibel. In ihrer Reduktion auf die nötigsten Elemente besticht sie durch die Klarheit ihrer funktionalen Details.

Pulkau Kugel Gelenk Wand

<p>Abgebildete Leuchte: Leuchtenkopf aus hochwertigem rostfreiem Aluminium, Tiefschwarz (A/S), opales Kugelglas bis 100 Watt, vernickeltes Zahngelenk, in die Alu-Gussrosette anschlussfertig verdrahtet</p> <p>Mit hochwertiger Porzellanfassung E27, für Glühlampen bis max. 60/100 Watt</p>	<p>Gusskopf-Ø 105 mm 120 mm</p> <p>Glas-Ø / Leuchtenhöhe mit Rosette 160 mm / 295 mm (max. 60 Watt) 180 mm / 325 mm (max. 100 Watt)</p> <p>Sonderausführungen auf Anfrage</p>	<p>Auch als Ecktype möglich (Best.-Nr. +Eck)</p>  <p>Rosette der Kupfer-Varianten</p> 	 E27  E27  230 V 50 Hz  IP 20 überdachter Außenbereich   elektrische Bauteile geprüft
---	---	---	--

Materialien - Oberflächen

Aluminium beschichtet / lackiert



Tiefschwarz
A/S



Reinweiß, RAL 9010
A/W

Sonderlackierung in RAL-Farbtönen möglich

Aluminium natur



ohne Lackierung
A/R



Klarlack matt
A/M



Klarlack glänzend
A/G

Kupfer natur



ohne Lackierung
K/R



Klarlack matt
K/M



Klarlack glänzend
K/G

Zahngelenk

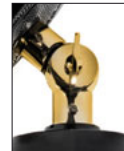

Messing poliert
Z/MP







Messing vernickelt
Z/MN

Eine harmonische Funktionsleuchte mit kegelförmigem Gusskopf, opalemem Schraubglas in Kugelform und Wandarm.
In ihrer Reduktion auf die nötigsten Elemente besticht sie durch die Klarheit ihrer funktionalen Details.



Pulkau KugelWand

<p>Abgebildete Leuchte: Leuchtenkopf aus hochwertigem rostfreiem Aluminium, Tiefschwarz (A/S), opales Kugelglas bis 60 Watt, komplett mit Alu-Wandarm Einrohr geschwungen 220 mm (W1500), in die Alu-Gussrosette anschlussfertig verdrahtet</p> <p>Mit hochwertiger Porzellanfassung E27, für Glühlampen bis max. 60/100 Watt</p>	<p>Gusskopf-Ø 105 mm 120 mm</p> <p>Glas-Ø / Leuchtenhöhe ohne Wandarm 160 mm / 200 mm (max. 60 Watt) 180 mm / 230 mm (max. 100 Watt)</p> <p>Sonderausführungen auf Anfrage</p>	<p>Einrohrige Alu-Wandarme auch als Ecktype möglich (Best.-Nr.+Eck)</p> <p>Rosette der Kupfer-Varianten</p>	  <p>E27 E27</p> <p>CE 230 V 50 Hz</p> <p>IP 54 Außenbereich</p> <p>  elektrische Bauteile geprüft</p>
--	--	---	---

Materialien - Oberflächen

Aluminium beschichtet / lackiert



Tiefschwarz
A/S



Reinweiß, RAL 9010
A/W

Sonderlackierung in RAL-Farbtönen möglich

Aluminium natur



ohne Lackierung
A/R



Klarlack matt
A/M



Klarlack glänzend
A/G

Kupfer natur



ohne Lackierung
K/R



Klarlack matt
K/M



Klarlack glänzend
K/G

Länge Best.-Nr. Wandarmausführungen

300 mm W330
350 mm W335
400 mm W340
450 mm W345
500 mm W350
600 mm W360
700 mm W370



Doppelrohr senkrecht (nur Aluminium)

300 mm W130
350 mm W135
400 mm W140
450 mm W145
500 mm W150
600 mm W160
700 mm W170

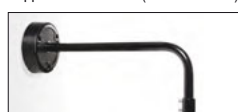

Einrohr senkrecht

370 mm W1600

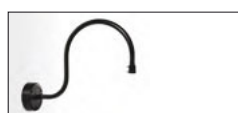

Einrohr geschwungen groß

■ Haupttypen

Länge Best.-Nr. Wandarmausführungen

300 mm W430
350 mm W435
400 mm W440
450 mm W445
500 mm W450
600 mm W460
700 mm W470



Doppelrohr schräg (nur Aluminium)

300 mm W230
350 mm W235
400 mm W240
450 mm W245
500 mm W250
600 mm W260
700 mm W270



Einrohr schräg

220 mm W1500



Einrohr geschwungen klein

■ Haupttypen



Eine einfache Funktionsleuchte mit Gelenk, kegelförmigem Gusskopf und Schraubglas in Zylinderform. Durch das hochwertige Zahngelenk ist ihr Neigungswinkel flexibel. In ihrer Reduktion auf die nötigsten Elemente besticht sie durch die Klarheit ihrer funktionalen Details.

Pulkau Zylinder Gelenk Wand

<p>Abgebildete Leuchte: Leuchtenkopf aus hochwertigem rostfreiem Aluminium, Tiefschwarz (A/S), klares Zylinderglas bis 60 Watt, vernickeltes Zahngelenk, in die Alu-Gussrosette anschlussfertig verdrahtet</p> <p>Mit hochwertiger Porzellanfassung E27, für Glühlampen bis max. 60/100 Watt</p>	<p>Gusskopf-Ø 105 mm 120 mm</p> <p>Glas-Ø / Leuchtenhöhe mit Rosette 100 mm / 295 mm (max. 60 Watt) 110 mm / 325 mm (max. 100 Watt)</p> <p>Extras • Zylinderglas auch in Matt lieferbar</p> <p>Sonderausführungen auf Anfrage</p>	<p>Auch als Ecktype möglich (Best.-Nr. + Eck)</p>  <p>Rosette der Kupfer-Varianten</p> 	 E27  E27  230 V 50 Hz  IP 20 überdächter Außenbereich  elektrische Bauteile geprüft
---	--	--	--

Materialien - Oberflächen

Aluminium beschichtet / lackiert



Tiefschwarz
A/S



Reinweiß, RAL 9010
A/W

Sonderlackierung in RAL-Farbtönen möglich

Aluminium natur



ohne Lackierung
A/R



Klarlack matt
A/M



Klarlack glänzend
A/G

Kupfer natur



ohne Lackierung
K/R



Klarlack matt
K/M



Klarlack glänzend
K/G

Zahngelenk



Messing poliert
Z/MP



Messing vernickelt
Z/MN

Eine einfache Funktionsleuchte mit kegelförmigem Gusskopf, Schraubglas in Zylinderform und Wandarm. In ihrer Reduktion auf die nötigsten Elemente besticht sie durch die Klarheit ihrer funktionalen Details.



Pulkau Zylinder Wand

<p>Abgebildete Leuchte: Leuchtenkopf aus hochwertigem rostfreiem Aluminium, Tiefschwarz (A/S), klares Zylinderglas bis 60 Watt, komplett mit Alu-Wandarm Einrohr geschwungen 220 mm (W1500), in die Alu-Gussrosette anschlussfertig verdrahtet</p> <p>Mit hochwertiger Porzellanfassung E27, für Glühlampen bis max. 60/100 Watt</p>	<p>Gusskopf-Ø 105 mm 120 mm</p> <p>Glas-Ø / Leuchtenhöhe ohne Wandarm 100 mm / 200 mm (max. 60 Watt) 110 mm / 230 mm (max. 100 Watt)</p> <p>Extras • Zylinderglas auch in Matt lieferbar</p> <p>Sonderausführungen auf Anfrage</p>	<p>Einrohrige Alu-Wandarme auch als Ecktype möglich (Best.-Nr.+Eck)</p> 	  <p>E27 E27</p>
<p>Rosette der Kupfer-Varianten</p> 		<p>CE 230 V 50 Hz</p> <p> IP 54 Außenbereich</p> <p>  elektrische Bauteile geprüft</p>	

Materialien - Oberflächen

Aluminium beschichtet / lackiert

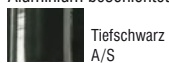

Sonderlackierung in RAL-Farbtönen möglich

Aluminium natur

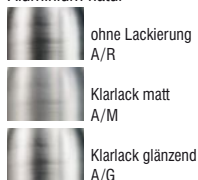

Kupfer natur



Länge Best.-Nr. Wandarmausführungen

300 mm	W330
350 mm	W335
400 mm	W340
450 mm	W345
500 mm	W350
600 mm	W360
700 mm	W370



Doppelrohr senkrecht (nur Aluminium)

300 mm	W130
350 mm	W135
400 mm	W140
450 mm	W145
500 mm	W150
600 mm	W160
700 mm	W170



Einrohr senkrecht

370 mm	W1600
--------	-------

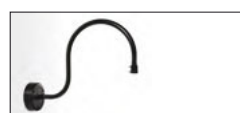

Einrohr geschwungen groß

■ Haupttypen

Länge Best.-Nr. Wandarmausführungen

300 mm	W430
350 mm	W435
400 mm	W440
450 mm	W445
500 mm	W450
600 mm	W460
700 mm	W470



Doppelrohr schräg (nur Aluminium)

300 mm	W230
350 mm	W235
400 mm	W240
450 mm	W245
500 mm	W250
600 mm	W260
700 mm	W270



Einrohr schräg

220 mm	W1500
--------	-------



Einrohr geschwungen klein

■ Haupttypen



Die Leuchte mit ihrem verspielt geschwungenen Schirm und Wandarm gehört zu unseren besonderen Klassikern. Aus traditionell gefertigten Guss- und Drückteilen sowie hochwertigen Porzellanelementen. Die ausgeprägten Formen der in der Druck- und Sicken-technik erzeugten Kubaturen verleihen ihr eine ganz besondere Ausdruckskraft.

Schwechat Wand

<p>Abgebildete Leuchte: Reflektor-Ø 350 mm, aus hochwertigem rostfreiem Aluminium, außen Tiefschwarz (A/S), innen Reinweiß, komplett mit Alu-Wandarm Doppelrohr senkrecht 400 mm (W340), in die Alu-Gussrosette anschlussfertig verdrahtet</p> <p>Mit hochwertiger Porzellanfassung E27, für Glühlampen bis max. 100 Watt</p>	<p>Reflektor-Ø / Leuchtenhöhe ohne Wandarm 350 mm / 270 mm</p> <p>Sonderausführungen auf Anfrage</p>	<p>Einrohrige Alu-Wandarme auch als Ecktype möglich (Best.-Nr. + Eck)</p> 	 E27  E27
		<p>Rosette der Kupfer-Varianten</p> 	<p>CE 230 V 50 Hz</p> <p>IP 20 Außenbereich</p> <p>  elektrische Bauteile geprüft</p>

Materialien - Oberflächen

Aluminium beschichtet / lackiert

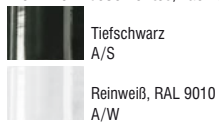

Sonderlackierung in RAL-Farbtönen möglich

Aluminium natur

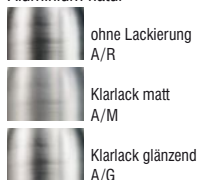

Kupfer natur



Länge Best.-Nr. Wandarmausführungen

300 mm	W330
350 mm	W335
400 mm	W340
450 mm	W345
500 mm	W350
600 mm	W360
700 mm	W370



300 mm	W130
350 mm	W135
400 mm	W140
450 mm	W145
500 mm	W150
600 mm	W160
700 mm	W170



370 mm	W1600
--------	-------

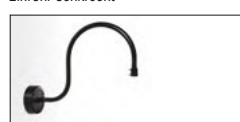

■ Haupttypen



Eine dominante Leuchte mit Halbkugel-Schirm, erhöhtem Aufsatz und Wandarm.
Aus traditionell gefertigten Guss- und Drückteilen sowie einzelnen Porzellanelementen. Sanft geschwungene konvex-konkave Formen und ihre funktionale Reduktion machen sie bis heute zu einem beliebten Klassiker für Hallen von Fertigung bis Showroom.

Klagenfurt Typ 2 Wand

<p>Abgebildete Leuchte: Reflektor-Ø 350 mm, aus hochwertigem rostfreiem Aluminium, außen Tiefschwarz (A/S), innen Reinweiß, komplett mit Alu-Wandarm Doppelrohr senkrecht 400 mm (W340), in die Alu-Gussrosette anschlussfertig verdrahtet</p> <p>Mit hochwertiger Porzellanfassung E27, für Glühlampen bis max. 100 Watt</p>	<p>Reflektor-Ø / Leuchtenhöhe ohne Wandarm 300 mm / 325 mm 350 mm / 350 mm</p> <p>Extras</p> <ul style="list-style-type: none"> • Aufbau auch geeignet für Sonderbestückungen mit Vorschaltgeräten <p>Sonderausführungen auf Anfrage</p>	<p>Einrohrige Alu-Wandarme auch als Ecktype möglich (Best.-Nr. + Eck)</p>  <p>Rosette der Kupfer-Varianten</p> 	 E27  E27  230 V 50 Hz  IP 20 Außenbereich   elektrische Bauteile geprüft
--	---	---	---

Materialien - Oberflächen

Aluminium beschichtet / lackiert



Tiefschwarz
A/S



Reinweiß, RAL 9010
A/W

Sonderlackierung in RAL-Farbtönen möglich

Aluminium natur



ohne Lackierung
A/R



Klarlack matt
A/M



Klarlack glänzend
A/G

Kupfer natur



ohne Lackierung
K/R



Klarlack matt
K/M



Klarlack glänzend
K/G

Länge Best.-Nr. Wandarmausführungen

300 mm	W330
350 mm	W335
400 mm	W340
450 mm	W345
500 mm	W350
600 mm	W360
700 mm	W370



Doppelrohr senkrecht (nur Aluminium)

300 mm	W130
350 mm	W135
400 mm	W140
450 mm	W145
500 mm	W150
600 mm	W160
700 mm	W170



Einrohr senkrecht

370 mm	W1600
--------	-------

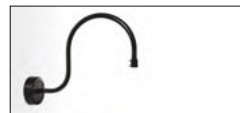

Einrohr geschwungen groß

■ Haupttypen



Die für ihre Zeit typische Leuchte mit schräg beschnittenem Reflektor legt ihren Schwerpunkt auf einfache Formen und Fügungen. Aus traditionell gefertigten Guss- und Drückteilen sowie einzelnen Porzellanelementen. Durch das hochwertige Gelenkteil ist ihr Neigungswinkel flexibel. Auch wenn es nichts gibt, was nicht einer eindeutigen Funktion folgt, besticht diese Wandleuchte gerade durch die Klarheit ihrer Form und Fertigung.

Penzing Wand

<p>Abgebildete Leuchte: Reflektor-Ø 150 mm, aus veredeltem Stahlblech, außen Tiefschwarz (S/S), innen Reinweiß, Gelenkteile vernickelt, 160 mm Rohrausleger Ø 16 mm, in die Alu-Gussrossette Ø 100 mm anschlussfertig verdrahtet</p> <p>Mit hochwertiger Porzellanfassung E27, für Glühlampen bis max. 100 Watt</p>	<p>Reflektor-Ø / Leuchtenhöhe 150 mm / 150 mm</p> <p>Standard-Rohrlänge / Gesamtausladung</p> <table border="0"> <tr><td>80 mm</td><td>/</td><td>245 mm</td></tr> <tr><td>120 mm</td><td>/</td><td>285 mm</td></tr> <tr><td>160 mm</td><td>/</td><td>325 mm</td></tr> <tr><td>200 mm</td><td>/</td><td>365 mm</td></tr> <tr><td>240 mm</td><td>/</td><td>405 mm</td></tr> </table> <p>Wand zu Vorderkante Reflektor = Gesamtausladung</p> <p>Extras</p> <ul style="list-style-type: none"> • Sonderlängen des Rohrauslegers auf Wunsch <p>Sonderausführungen auf Anfrage</p>	80 mm	/	245 mm	120 mm	/	285 mm	160 mm	/	325 mm	200 mm	/	365 mm	240 mm	/	405 mm	<p>Einrohrige Alu-Wandarme auch als Ecktype möglich (Best.-Nr. + Eck)</p>  <p>Rosette der Kupfer-Varianten</p> 	 E27  E27  230 V 50 Hz  IP 20   elektrische Bauteile geprüft
80 mm	/	245 mm																
120 mm	/	285 mm																
160 mm	/	325 mm																
200 mm	/	365 mm																
240 mm	/	405 mm																

Materialien - Oberflächen

Stahlblech beschichtet / lackiert



Tiefschwarz
A/S



Reinweiß, RAL 9010
A/W

Sonderlackierung in RAL-Farbtönen möglich

Aluminium natur



ohne Lackierung
A/R



Klarlack matt
A/M



Klarlack glänzend
A/G

Stahlblech natur



Klarlack matt
S/M



Klarlack glänzend
S/G

Kupfer natur



ohne Lackierung
K/R



Klarlack matt
K/M







Klarlack glänzend
K/G



Die Leuchte mit Halbkugel-Reflektor, erhöhtem Kuppelaufsatz und Wandarm beeindruckt durch ihr Spiel mit Form und Größe.

Aus traditionell gefertigten Guss- und Drückteilen sowie einzelnen Porzellanelementen. Dort, wo in Zweckbauten und anderen großen Räumlichkeiten noch Wert auf stimmige Details gelegt wird, bietet sie eine prägnante Abrundung.

Klagenfurt Typ 1 Wand

<p>Abgebildete Leuchte: Reflektor-Ø 500 mm, aus hochwertigem rostfreiem Aluminium, außen Tiefschwarz (A/S), innen Reinweiß, komplett mit Alu-Wandarm Doppelrohr senkrecht 400 mm (W340), in die Alu-Gussrosette anschlussfertig verdrahtet</p> <p>Mit hochwertiger Porzellanfassung E27, für Glühlampen bis max. 100 Watt</p>	<p>Reflektor-Ø / Leuchtenhöhe ohne Wandarm</p> <ul style="list-style-type: none"> ■ 350 mm / 375 mm ■ 400 mm / 400 mm ■ 500 mm / 450 mm <p>Haupttypen</p> <p>Extras</p> <ul style="list-style-type: none"> • E40 für Glühlampen bis 1000 Watt bei Ø 500 mm • Aufbau auch geeignet für Sonderbestückungen mit Vorschaltgeräten <p>Sonderausführungen auf Anfrage</p>	<p>Einrohrige Alu-Wandarme auch als Ecktype möglich (Best.-Nr. + Eck)</p>  <p>Rosette der Kupfer-Varianten</p> 	 <p>E27</p>  <p>E27</p>  <p>E40</p> <p>CE 230 V 50 Hz</p> <p>IP 20 Außenbereich</p> <p>  elektrische Bauteile geprüft</p>
--	--	---	---

Materialien - Oberflächen

Aluminium beschichtet / lackiert



Tiefschwarz
A/S



Reinweiß, RAL 9010
A/W

Sonderlackierung in RAL-Farbtönen möglich

Aluminium natur



ohne Lackierung
A/R



Klarlack matt
A/M



Klarlack glänzend
A/G

Kupfer natur



ohne Lackierung
K/R



Klarlack matt
K/M



Klarlack glänzend
K/G

Länge Best.-Nr. Wandarmausführungen

300 mm	W330
350 mm	W335
400 mm	W340
450 mm	W345
500 mm	W350
600 mm	W360
700 mm	W370



Doppelrohr senkrecht (nur Aluminium)

300 mm	W130
350 mm	W135
400 mm	W140
450 mm	W145
500 mm	W150
600 mm	W160
700 mm	W170



Einrohr senkrecht

■ Haupttypen



Die Leuchte mit Reflektor und Wandarm rückt ihr elegantes opales Ring-Glas in den Vordergrund. Aus traditionell gefertigten Guss- und Drückteilen sowie einzelnen Porzellanelementen. Das nach unten offene zylindrische Opalglass kontrastiert besonders schön in der tiefschwarzen Variante mit dem für die Entstehungszeit schlichten Aufbau.

Klagenfurt Glas Typ 3 Wand

<p>Abgebildete Leuchte: Reflektor-Ø 420 mm, aus hochwertigem rostfreiem Aluminium, außen Tiefschwarz (A/S), innen Reinweiß, komplett mit Alu-Wandarm Doppelrohr senkrecht 400 mm (W340), in die Alu-Gussrosette anschlussfertig verdrahtet</p> <p>Mit hochwertiger Porzellanfassung E27, für Glühlampen bis max. 100 Watt</p>	<p>Reflektor-Ø 420 mm</p> <p>Glas-Ø / Leuchtenhöhe ohne Wandarm 260 mm / 410 mm</p> <p>Extras</p> <ul style="list-style-type: none"> • E40 für Glühlampen bis 1000 Watt • Aufbau auch geeignet für Sonderbestückungen mit Vorschaltgeräten <p>Sonderausführungen auf Anfrage</p>	<p>Einrohrige Alu-Wandarme auch als Ecktype möglich (Best.-Nr. + Eck)</p>  <p>Rosette der Kupfer-Varianten</p> 	 <p>E27</p>  <p>E27</p>  <p>E40</p> <p>CE 230 V 50 Hz</p> <p>IP 20 Außenbereich</p> <p>  elektrische Bauteile geprüft</p>
--	---	---	---

Materialien - Oberflächen

Aluminium beschichtet / lackiert

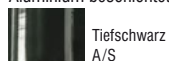

Sonderlackierung in RAL-Farbtönen möglich

Aluminium natur

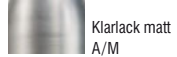

Kupfer natur

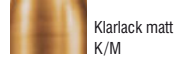
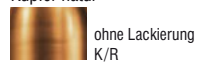

Länge Best.-Nr. Wandarmausführungen

300 mm	W330
350 mm	W335
400 mm	W340
450 mm	W345
500 mm	W350
600 mm	W360
700 mm	W370



300 mm	W130
350 mm	W135
400 mm	W140
450 mm	W145
500 mm	W150
600 mm	W160
700 mm	W170



■ Haupttypen



Eine offene Leuchte mit hutähnlichem Reflektor und großzügig ausgebildetem opalem Ring-Glas.

Aus traditionell gefertigten Guss- und Drückteilen sowie einzelnen Porzellanelementen. Besonders in der tiefschwarzen Variante kann der schlichte weiße Glasschirm seine Wirkung entfalten.

Klagenfurt Glas Typ 4 Wand

<p>Abgebildete Leuchte: Reflektor-Ø 420 mm, aus hochwertigem rostfreiem Aluminium, außen Tiefschwarz (A/S), innen Reinweiß, komplett mit Alu-Wandarm Doppelrohr senkrecht 400 mm (W340), in die Alu-Gussrosette anschlussfertig verdrahtet</p> <p>Mit hochwertiger Porzellanfassung E27, für Glühlampen bis max. 100 Watt</p>	<p>Reflektor-Ø 420 mm</p> <p>Glas-Ø / Leuchtenhöhe ohne Wandarm 260 mm / 385 mm</p> <p>Extras</p> <ul style="list-style-type: none"> • E40 für Glühlampen bis 1000 Watt • Aufbau auch geeignet für Sonderbestückungen mit Vorschaltgeräten <p>Sonderausführungen auf Anfrage</p>	<p>Einrohrige Alu-Wandarme auch als Ecktype möglich (Best.-Nr.+Eck)</p>  <p>Rosette der Kupfer-Varianten</p> 	 E27  E27  E40 <p>CE 230 V 50 Hz</p> <p>IP 20 Außenbereich</p> <p>  elektrische Bauteile geprüft</p>
--	---	---	--

Materialien - Oberflächen

Aluminium beschichtet / lackiert



Sonderlackierung in RAL-Farbtönen möglich

Aluminium natur



Kupfer natur

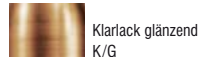
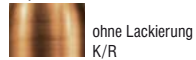

Länge Best.-Nr. Wandarmausführungen

300 mm	W330
350 mm	W335
400 mm	W340
450 mm	W345
500 mm	W350
600 mm	W360
700 mm	W370



300 mm	W130
350 mm	W135
400 mm	W140
450 mm	W145
500 mm	W150
600 mm	W160
700 mm	W170

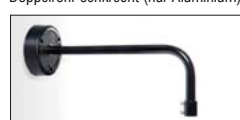



■ Haupttypen

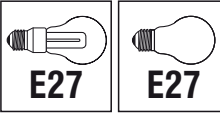

Die Leuchte mit ihrem eigenwilligen Reflektor und in den Vordergrund tretenden Zylinderglas mit Wandarm ist ein besonderer Klassiker der Kollektion EBOLICHT. Optisch reduziert auf zwei traditionell gefertigte Druckteile mit sichtbaren Schraubverbindungen. Das schlichte Spiel des Doppelreflektors erlaubt es, in unterschiedlichsten Architektursprachen markante und doch zeitlose Akzente zu setzen.

Nussdorf Zylinder Wand

<p>Abgebildete Leuchte: Doppelreflektor-Ø 300 mm, aus hochwertigem rostfreiem Aluminium, Oberseite Tiefschwarz (A/S), Unterseite Reinweiß, klares Zylinderglas bis 60 Watt, komplett mit Alu-Wandarm Einrohr schräg 300 mm (W230), in die Alu-Gussrosette anschlussfertig verdrahtet</p> <p>Mit hochwertiger Porzellanfassung E27, für Glühlampen bis max. 60/100 Watt</p>	<p>Reflektor-Ø 300 mm 350 mm</p> <p>Glas-Ø / Leuchtenhöhe ohne Wandarm 100 mm / 240 mm (max. 60 Watt) 110 mm / 270 mm (max. 100 Watt)</p> <p>Extras • Zylinderglas auch in Matt lieferbar</p> <p>Sonderausführungen auf Anfrage</p>	<p>Einrohrige Alu-Wandarme auch als Ecktype möglich (Best.-Nr.+Eck)</p> 	 <p>E27 E27</p>
		<p>Rosette der Kupfer-Varianten</p> 	<p>CE 230 V 50 Hz</p> <p>IP 54 Außenbereich</p> <p> elektrische Bauteile geprüft</p>

Materialien - Oberflächen

Aluminium beschichtet / lackiert

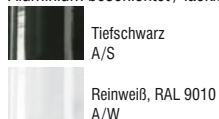

Sonderlackierung in RAL-Farbtönen möglich

Aluminium natur

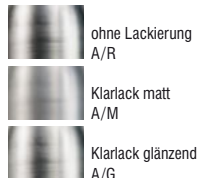

Kupfer natur



Länge Best.-Nr. Wandarmausführungen

300 mm	W330
350 mm	W335
400 mm	W340
450 mm	W345
500 mm	W350
600 mm	W360
700 mm	W370



300 mm	W130
350 mm	W135
400 mm	W140
450 mm	W145
500 mm	W150
600 mm	W160
700 mm	W170



370 mm	W1600
--------	-------



Länge Best.-Nr. Wandarmausführungen

300 mm	W430
350 mm	W435
400 mm	W440
450 mm	W445
500 mm	W450
600 mm	W460
700 mm	W470



300 mm	W230
350 mm	W235
400 mm	W240
450 mm	W245
500 mm	W250
600 mm	W260
700 mm	W270

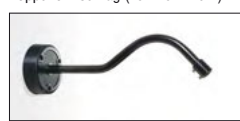

■ Haupttypen

■ Haupttypen











Die schlichten, aber hochwertigen Beschläge oder auch der asymmetrisch vorstehende Reflektor machen aus dem spröden Klassiker ein selten erreichtes Original.

Aus traditionell gefertigten Guss- und Drückteilen sowie einzelnen Porzellanelementen.

Durch das hochwertige Gelenkteil ist ihr Neigungswinkel flexibel. Besonders in der tiefschwarzen Variante besticht sie durch ihre Klarheit in Form und Farbe.

Hietzing Wand

<p>Abgebildete Leuchte: Reflektor-Ø 235 mm, aus veredeltem Stahlblech, außen Tiefschwarz (A/S), innen Reinweiß, Gelenkteile vernickelt, 240 mm Rohrausleger Ø 16 mm, in die Alu-Gussrossette Ø 100 mm anschlussfertig verdrahtet</p> <p>Mit hochwertiger Porzellanfassung E27, für Glühlampen bis max. 100 Watt</p>	<p>Reflektor-Ø / Leuchtenhöhe 235 mm / 200 mm</p> <p>Standard-Rohrlänge / Gesamtausladung</p> <table border="0"> <tr><td>80 mm</td><td>/</td><td>310 mm</td></tr> <tr><td>120 mm</td><td>/</td><td>350 mm</td></tr> <tr><td>160 mm</td><td>/</td><td>390 mm</td></tr> <tr><td>200 mm</td><td>/</td><td>430 mm</td></tr> <tr><td>240 mm</td><td>/</td><td>470 mm</td></tr> </table> <p>Wand zu Vorderkante Reflektor = Gesamtausladung</p> <p>Extras</p> <ul style="list-style-type: none"> • Sonderlängen des Rohrauslegers auf Wunsch <p>Sonderausführungen auf Anfrage</p>	80 mm	/	310 mm	120 mm	/	350 mm	160 mm	/	390 mm	200 mm	/	430 mm	240 mm	/	470 mm	<p>Einrohrige Alu-Wandarme auch als Ecktype möglich (Best.-Nr. + Eck)</p>  <p>Rosette der Kupfer-Varianten</p> 	 E27  E27  230 V 50 Hz  IP 20   elektrische Bauteile geprüft
80 mm	/	310 mm																
120 mm	/	350 mm																
160 mm	/	390 mm																
200 mm	/	430 mm																
240 mm	/	470 mm																

Materialien - Oberflächen

Stahlblech beschichtet / lackiert

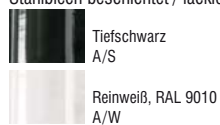

Sonderlackierung in RAL-Farbtönen möglich

Aluminium natur

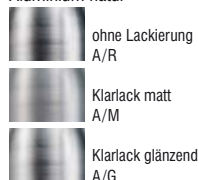

Stahlblech natur











Kupfer natur





Eine funktionale Leuchte mit angeschnittenem Kegelschirm. Aus traditionell gefertigten Guss- und Druckteilen sowie einzelnen Porzellanelementen. Durch das hochwertige Zahngelenk ist ihr Neigungswinkel flexibel. Wie viele andere Zweckleuchten hat die ehemalige Schrankbeleuchtung ihren ganz besonderen Charme.

Bregenz Gelenk Wand

<p>Abgebildete Leuchte: Reflektorgröße 350 mm x 290 mm, aus hochwertigem rostfreiem Aluminium, außen Tiefschwarz (A/S), innen Reinweiß, vernickeltes Zahngelenk, in die Alu-Gussrosette anschlussfertig verdrahtet</p> <p>Mit hochwertiger Porzellanfassung E27, für Glühlampen bis max. 100 Watt</p>	<p>Reflektoröffnung 280 mm x 230 mm = Typ 306 350 mm x 290 mm = Typ 307</p> <p>Leuchtenhöhe mit Rosette (bei Wandmontage und waagrecht Reflektor) 285 mm = Typ 306 335 mm = Typ 307 (Ausladung von Wand bis Vorderkante Reflektor) 425 mm = Typ 306 475 mm = Typ 307</p> <p>Sonderausführungen auf Anfrage</p>	<p>Auch als Ecktype möglich (Best.-Nr. + Eck)</p>  <p>Rosette der Kupfer-Varianten</p> 	 E27  E27  230 V 50 Hz  IP 20 überdachter Außenbereich   elektrische Bauteile geprüft
--	--	--	--

Materialien - Oberflächen

Aluminium beschichtet / lackiert

 Tiefschwarz
A/S

 Reinweiß, RAL 9010
A/W

Sonderlackierung in RAL-Farbtönen möglich

Aluminium natur

 ohne Lackierung
A/R

 Klarlack matt
A/M

 Klarlack glänzend
A/G

Kupfer natur

 ohne Lackierung
K/R

 Klarlack matt
K/M

 Klarlack glänzend
K/G

Zahngelenk



Messing poliert
Z/MP



Messing vernickelt
Z/MN



Eine funktionale Wandleuchte mit angeschnittenem Kegelschirm. Aus traditionell gefertigten Guss- und Drückteilen sowie einzelnen Porzellanelementen. Wie viele andere Zweckleuchten hat die ehemalige Schrankenbeleuchtung ihren ganz besonderen Charme. Auch heute gerne als Außenleuchte verwendet, kommt sie überdeckt oder in der Fläche montiert sehr wirkungsvoll zur Geltung.

Bregenz Wand

<p>Abgebildete Leuchte: Reflektorgroße 350 mm x 290 mm, aus hochwertigem rostfreiem Aluminium, außen Tiefschwarz (A/S), innen Reinweiß, komplett mit Alu-Wandarm Doppelrohr, Bild vorn: senkrecht 400 mm (W340), Bild hinten: schräg 400 mm (W440), in die Alu-Gussrosette anschlussfertig verdrahtet</p> <p>Mit hochwertiger Porzellanfassung E27, für Glühlampen bis max. 100 Watt</p>	<p>Reflektoröffnung 280 mm x 230 mm = Typ 306 350 mm x 290 mm = Typ 307</p> <p>Leuchtenhöhe ohne Wandarm 210 mm = Typ 306 260 mm = Typ 307</p> <p>Sonderausführungen auf Anfrage</p>	<p>Einrohrige Alu-Wandarme auch als Ecktype möglich (Best.-Nr.+Eck)</p>  <p>Rosette der Kupfer-Varianten</p> 	 E27  E27  230 V 50 Hz  IP 20 Außenbereich  elektrische Bauteile geprüft
---	--	---	--

Materialien - Oberflächen

Aluminium beschichtet / lackiert



Tiefschwarz
A/S



Reinweiß, RAL 9010
A/W

Sonderlackierung in RAL-Farbtönen möglich

Aluminium natur



ohne Lackierung
A/R



Klarlack matt
A/M



Klarlack glänzend
A/G

Kupfer natur



ohne Lackierung
K/R



Klarlack matt
K/M



Klarlack glänzend
K/G

Länge Best.-Nr. Wandarmausführungen

300 mm W330
350 mm W335
400 mm W340
450 mm W345
500 mm W350
600 mm W360
700 mm W370



Doppelrohr senkrecht (nur Aluminium)

300 mm W130
350 mm W135
400 mm W140
450 mm W145
500 mm W150
600 mm W160
700 mm W170

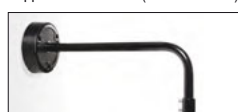

Einrohr senkrecht

370 mm W1600

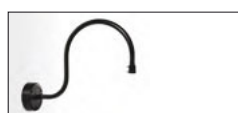

Einrohr geschwungen groß

■ Haupttypen

Länge Best.-Nr. Wandarmausführungen

300 mm W430
350 mm W435
400 mm W440
450 mm W445
500 mm W450
600 mm W460
700 mm W470



Doppelrohr schräg (nur Aluminium)

300 mm W230
350 mm W235
400 mm W240
450 mm W245
500 mm W250
600 mm W260
700 mm W270



Einrohr schräg

220 mm W1500







Einrohr geschwungen klein

■ Haupttypen



Eine offene Leuchte mit hutähnlichem Reflektor, großzügig ausgebildetem opalenem Ring-Glas und Wandarm. Aus traditionell gefertigten Guss- und Drückteilen sowie einzelnen Porzellanelementen. Besonders in der tiefschwarzen Variante kann der schlichte weiße Glasschirm seine Wirkung entfalten.

Kapfenberg Typ 1 Wand

<p>Abgebildete Leuchte: Reflektor-Ø 400 mm, aus hochwertigem rostfreiem Aluminium, außen Tiefschwarz (A/S), innen Reinweiß, opalenes Glas, komplett mit Alu-Wandarm Doppelrohr senkrecht 400 mm (W340), in die Alu-Gussrosette anschlussfertig verdrahtet</p> <p>Mit hochwertiger Porzellanfassung E27, für Glühlampen bis max. 100 Watt</p>	<p>Reflektor-Ø / Leuchtenhöhe ohne Wandarm 300 mm / 230 mm 350 mm / 230 mm 400 mm / 230 mm</p> <p>Glas-Ø / Glashöhe 230 mm / 155 mm</p> <p>Sonderausführungen auf Anfrage</p>	<p>Einrohrige Alu-Wandarme auch als Ecktype möglich (Best.-Nr. + Eck)</p>  <p>Rosette der Kupfer-Varianten</p> 	 E27  E27  230 V 50 Hz  IP 20 Außenbereich   elektrische Bauteile geprüft
---	---	---	---

Materialien - Oberflächen

Aluminium beschichtet / lackiert

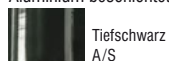

Sonderlackierung in RAL-Farbtönen möglich

Aluminium natur

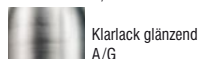

Kupfer natur

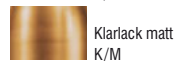
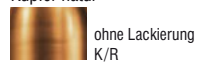

Länge Best.-Nr. Wandarmausführungen

300 mm	W330
350 mm	W335
400 mm	W340
450 mm	W345
500 mm	W350
600 mm	W360
700 mm	W370



300 mm	W130
350 mm	W135
400 mm	W140
450 mm	W145
500 mm	W150
600 mm	W160
700 mm	W170



370 mm	W1600
--------	-------

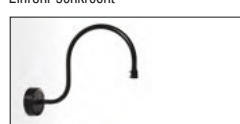





■ Haupttypen



Eine kompakte Leuchte mit hutähnlichem Reflektor, unten offenem Spitzzylinder-Glas und Wandarm.
Aus traditionell gefertigten Guss- und Drückteilen sowie einzelnen Porzellanelementen. Als Nutzleuchte überzeugt sie durch ihre ausgewogenen Proportionen.

Kapfenberg Typ2 Wand

<p>Abgebildete Leuchte: Reflektor-Ø 400 mm, aus hochwertigem rostfreiem Aluminium, außen Tiefschwarz (A/S), innen Reinweiß, klares Spitzzylinder-Glas, komplett mit Alu-Wandarm Doppelrohr senkrecht 400 mm (W340), in die Alu-Gussrosette anschlussfertig verdrahtet</p> <p>Mit hochwertiger Porzellanfassung E27, für Glühlampen bis max. 100 Watt</p>	<p>Reflektor-Ø / Leuchtenhöhe ohne Wandarm 300 mm / 230 mm 350 mm / 230 mm 400 mm / 230 mm</p> <p>Glas-Ø / Glashöhe 150 mm / 155 mm</p> <p>Sonderausführungen auf Anfrage</p>	<p>Einrohrige Alu-Wandarme auch als Ecktype möglich (Best.-Nr. + Eck)</p>  <p>Rosette der Kupfer-Varianten</p> 	 E27  E27  230 V 50 Hz  IP 20 Außenbereich   elektrische Bauteile geprüft
---	---	--	---

Materialien - Oberflächen

Aluminium beschichtet / lackiert

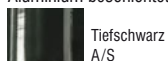

Sonderlackierung in RAL-Farbtönen möglich

Aluminium natur

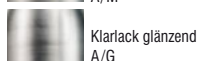

Kupfer natur

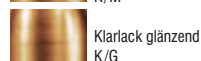
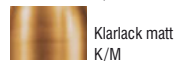

Länge Best.-Nr. Wandarmausführungen

300 mm	W330
350 mm	W335
400 mm	W340
450 mm	W345
500 mm	W350
600 mm	W360
700 mm	W370



300 mm	W130
350 mm	W135
400 mm	W140
450 mm	W145
500 mm	W150
600 mm	W160
700 mm	W170



370 mm	W1600
--------	-------

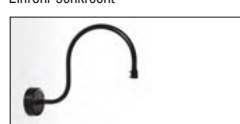

■ Haupttypen



Eine formschöne Wandleuchte mit angeschnittenem Kegelschirm. Aus traditionell gefertigten Guss- und Drückteilen sowie einzelnen Porzellanelementen. Das reiche Wechselspiel von geraden und geschwungenen Elementen macht die Leuchte zu einem typischen Vertreter des jungen 20. Jahrhunderts.

Bregenz Aufbau Wand

<p>Abgebildete Leuchte: Reflektor mit Aufbau und Abdeckkappe aus hochwertigem rostfreiem Aluminium, außen Tiefschwarz (A/S), innen Reinweiß, klares Zylinderglas, komplett mit Alu-Wandarm Doppelrohr, Bild vorn: senkrecht 400 mm (W340), Bild hinten: schräg 400 mm (W440), in die Alu-Gussrossette anschlussfertig verdrahtet</p> <p>Mit hochwertiger Porzellanfassung E27, für Glühlampen bis max. 100/200 Watt</p>	<p>Reflektoröffnung 390 x 340 mm</p> <p>Glas-Ø / Leuchtenhöhe ohne Wandarm 140 mm / 320 mm (max. 200 Watt)</p> <p>Extras</p> <ul style="list-style-type: none"> • Zylinderglas auch in Matt lieferbar • Auch ohne Glas bestellbar <p>Sonderausführungen auf Anfrage</p>	<p>Einrohrige Alu-Wandarme auch als Ecktype möglich (Best.-Nr.+Eck)</p>  <p>Rosette der Kupfer-Varianten</p> 	 E27  E27  230 V 50 Hz  IP 54 Außenbereich   elektrische Bauteile geprüft
--	--	---	---

Materialien - Oberflächen

Aluminium beschichtet / lackiert

 Tiefschwarz
A/S

 Reinweiß, RAL 9010
A/W

Sonderlackierung in RAL-Farbtönen möglich

Aluminium natur

 ohne Lackierung
A/R

 Klarlack matt
A/M

 Klarlack glänzend
A/G

Kupfer natur

 ohne Lackierung
K/R

 Klarlack matt
K/M

 Klarlack glänzend
K/G

Länge Best.-Nr. Wandarmausführungen

300 mm W330
350 mm W335
400 mm W340
450 mm W345
500 mm W350
600 mm W360
700 mm W370



Doppelrohr senkrecht (nur Aluminium)

300 mm W130
350 mm W135
400 mm W140
450 mm W145
500 mm W150
600 mm W160
700 mm W170



Einrohr senkrecht

370 mm W1600



Einrohr geschwungen groß

■ Haupttypen

Länge Best.-Nr. Wandarmausführungen

300 mm W430
350 mm W435
400 mm W440
450 mm W445
500 mm W450
600 mm W460
700 mm W470



Doppelrohr schräg (nur Aluminium)

300 mm W230
350 mm W235
400 mm W240
450 mm W245
500 mm W250
600 mm W260
700 mm W270



Einrohr schräg

■ Haupttypen



Die technisch geprägte Leuchte mit Halbkugel-Schirm, großem zylindrischem Aufsatz und Wandarm. Aus traditionell gefertigten Guss- und Drückteilen sowie einzelnen Porzellanelementen. In der Variante aus Aluminium ist ihr industrieller Charme besonders präsent.

Freudenau Wand

<p>Abgebildete Leuchte: Reflektor-Ø 400 mm, aus hochwertigem rostfreiem Aluminium, außen Tiefschwarz (A/S), innen Reinweiß, komplett mit Alu-Wandarm Doppelrohr senkrecht 400 mm (W340), in die Alu-Gussrosette anschlussfertig verdrahtet</p> <p>Mit hochwertiger Porzellanfassung E27, für Glühlampen bis max. 100 Watt</p>	<p>Reflektor-Ø / Leuchtenhöhe ohne Wandarm 400 mm / 390 mm 500 mm / 440 mm</p> <p>Extras</p> <ul style="list-style-type: none"> • E40 für Glühlampen bis 1000 Watt bei Ø 500 mm • Besonders großer Aufbau auch geeignet für Sonderbestückung mit Vorschalt- und Zündgeräten <p>Sonderausführungen auf Anfrage</p>	<p>Einrohrige Alu-Wandarme auch als Ecktype möglich (Best.-Nr. + Eck)</p>  <p>Rosette der Kupfer-Varianten</p> 	 E27  E27  E40 <p>CE 230 V 50 Hz</p> <p>IP 20 Außenbereich</p> <p>  elektrische Bauteile geprüft</p>
--	---	---	--

Materialien - Oberflächen

Aluminium beschichtet / lackiert

 Tiefschwarz A/S

 Reinweiß, RAL 9010 A/W

Sonderlackierung in RAL-Farbtönen möglich

Aluminium natur

 ohne Lackierung A/R

 Klarlack matt A/M

 Klarlack glänzend A/G

Kupfer natur

 ohne Lackierung K/R

 Klarlack matt K/M

 Klarlack glänzend K/G

Länge Best.-Nr. Wandarmausführungen

300 mm W330
350 mm W335
400 mm W340
450 mm W345
500 mm W350
600 mm W360
700 mm W370



Doppelrohr senkrecht (nur Aluminium)

300 mm W130
350 mm W135
400 mm W140
450 mm W145
500 mm W150
600 mm W160
700 mm W170









Einrohr senkrecht

■ Haupttypen



Die Leuchte mit Halbkugel-Schirm, runder Kuppel und Wandarm besticht durch ihr expressives Volumen. Aus traditionell gefertigten Guss- und Drückteilen sowie einzelnen Porzellanelementen. Durch den stark gewölbten Reflektor verbreitet die Leuchte ein besonders angenehmes und blendfreies Licht.

Penzing Wand

<p>Abgebildete Leuchte: Reflektor-Ø 350 mm, aus hochwertigem rostfreiem Aluminium, außen Tiefschwarz (A/S), innen Reinweiß, komplett mit Alu-Wandarm Einrohr senkrecht 300 mm (W130), in die Alu-Gussrosette anschlussfertig verdrahtet</p> <p>Mit hochwertiger Porzellanfassung E27, für Glühlampen bis max. 100 Watt</p>	<p>Reflektor-Ø / Leuchtenhöhe ohne Wandarm</p> <ul style="list-style-type: none"> ■ 250 mm / 180 mm ■ 300 mm / 240 mm ■ 350 mm / 255 mm ■ 400 mm / 270 mm ■ 500 mm / 320 mm <p>Haupttypen</p> <p>Extras</p> <ul style="list-style-type: none"> • E40 für Glühlampen bis 1000 Watt bei Ø 500 mm <p>Sonderausführungen auf Anfrage</p>	<p>Einrohrige Alu-Wandarme auch als Ecktype möglich (Best.-Nr. + Eck)</p>  <p>Rosette der Kupfer-Varianten</p> 	 E27  E27  E40 <p>CE 230 V 50 Hz</p> <p>IP 20 Außenbereich</p> <p>  elektrische Bauteile geprüft</p>
---	--	---	--

Materialien - Oberflächen

Aluminium beschichtet / lackiert

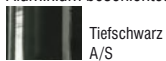

Sonderlackierung in RAL-Farbtönen möglich

Aluminium natur

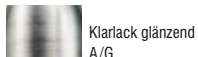

Kupfer natur

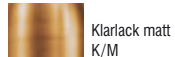

Länge Best.-Nr. Wandarmausführungen

300 mm	W330
350 mm	W335
400 mm	W340
450 mm	W345
500 mm	W350
600 mm	W360
700 mm	W370



300 mm	W130
350 mm	W135
400 mm	W140
450 mm	W145
500 mm	W150
600 mm	W160
700 mm	W170



370 mm	W1600
--------	-------

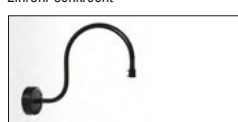







■ Haupttypen

Eine formschöne Leuchte mit klassischem Halbkugel-Reflektor und Wandarm.
 Aus traditionell gefertigten Drückteilen sowie einzelnen Porzellanelementen.
 Durch den schräg angesetzten Fassungs Aufbau verbreitert die Leuchte ein besonders angenehmes und blendfreies Licht.
 Eine ideale Leuchte zum Anstrahlen von Bildern oder Wandschildern im Innen- und Außenbereich.



Hernal's Wand

<p>Abgebildete Leuchte: Reflektor-Ø 200 mm, aus hochwertigem rostfreiem Aluminium, außen Tiefschwarz (A/S), innen Reinweiß, komplett mit Alu-Wandarm Einrohr geschwungen 370 mm (W1600), in die Alu-Gussrossette anschlussfertig verdrahtet</p> <p>Mit hochwertiger Porzellanfassung E27, für Glühlampen bis max. 100 Watt</p>	<p>Reflektor-Ø 200 mm</p> <p>Extras</p> <ul style="list-style-type: none"> Für den Innenbereich auch aus Stahlblech möglich <p>Sonderausführungen auf Anfrage</p>	<p>Einrohrige Alu-Wandarme auch als Ecktype möglich (Best.-Nr. + Eck)</p> 	  <p>E27 E27</p>
		<p>Rosette der Kupfer-Varianten</p> 	<p>CE 230 V 50 Hz</p> <p> IP 20 Außenbereich</p> <p>  elektrische Bauteile geprüft</p>

Materialien - Oberflächen

Aluminium beschichtet / lackiert

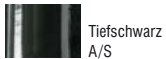

Sonderlackierung in RAL-Farbtönen möglich

Aluminium natur



Kupfer natur

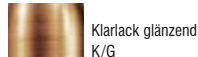
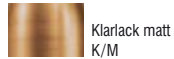
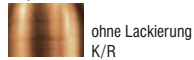

Länge Best.-Nr. Wandarmausführungen

300 mm	W330
350 mm	W335
400 mm	W340
450 mm	W345
500 mm	W350
600 mm	W360
700 mm	W370



300 mm	W130
350 mm	W135
400 mm	W140
450 mm	W145
500 mm	W150
600 mm	W160
700 mm	W170



370 mm	W1600
--------	-------

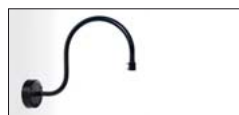

■ Haupttypen

Länge Best.-Nr. Wandarmausführungen

300 mm	W430
350 mm	W435
400 mm	W440
450 mm	W445
500 mm	W450
600 mm	W460
700 mm	W470



300 mm	W230
350 mm	W235
400 mm	W240
450 mm	W245
500 mm	W250
600 mm	W260
700 mm	W270



220 mm	W1500
--------	-------











■ Haupttypen



Eine eigenwillige Leuchte mit gewölbtem Reflektor, dominantem opalem Ring-Glas und Wandarm. Aus traditionell gefertigten Guss- und Drückteilen sowie einzelnen Porzellanelementen. Diese Leuchte diente früher als klassische Hofleuchte.

Leoben Wand

<p>Abgebildete Leuchte: Reflektor-Ø 250 mm, aus hochwertigem rostfreiem Aluminium, außen Tiefschwarz (A/S), innen Reinweiß, opales Glas, komplett mit Alu-Wandarm Einrohr schräg 400 mm (W240), in die Alu-Gussrosette anschlussfertig verdrahtet</p> <p>Mit hochwertiger Porzellanfassung E27, für Glühlampen bis max. 100 Watt</p>	<p>Reflektor-Ø / Leuchtenhöhe ohne Wandarm 250 mm / 180 mm 300 mm / 225 mm</p> <p>Glas-Ø / Glashöhe 170 mm / 160 mm 230 mm / 225 mm</p> <p>Sonderausführungen auf Anfrage</p>	<p>Einrohrige Alu-Wandarme auch als Ecktype möglich (Best.-Nr. + Eck)</p>  <p>Rosette der Kupfer-Varianten</p> 	 E27  E27  230 V 50 Hz  IP 20 Außenbereich   elektrische Bauteile geprüft
---	---	---	---

Materialien - Oberflächen

Aluminium beschichtet / lackiert

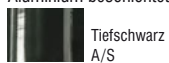

Sonderlackierung in RAL-Farbtönen möglich

Aluminium natur

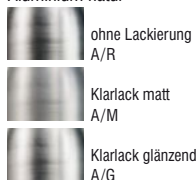

Kupfer natur



Länge Best.-Nr. Wandarmausführungen

300 mm	W330
350 mm	W335
400 mm	W340
450 mm	W345
500 mm	W350
600 mm	W360
700 mm	W370



Doppelrohr senkrecht (nur Aluminium)



Einrohr senkrecht

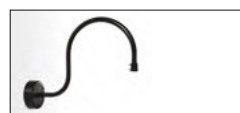

Einrohr geschwungen groß

300 mm	W130
350 mm	W135
400 mm	W140
450 mm	W145
500 mm	W150
600 mm	W160
700 mm	W170

370 mm	W1600
--------	-------

■ Haupttypen

Länge Best.-Nr. Wandarmausführungen

300 mm	W430
350 mm	W435
400 mm	W440
450 mm	W445
500 mm	W450
600 mm	W460
700 mm	W470



Doppelrohr schräg (nur Aluminium)



Einrohr schräg

300 mm	W230
350 mm	W235
400 mm	W240
450 mm	W245
500 mm	W250
600 mm	W260
700 mm	W270

220 mm	W1500
--------	-------

■ Haupttypen



Einrohr geschwungen klein



Die Leuchte mit Halbkugel-Schirm, zylindrischer Kuppel und Wandarm besticht durch ihr expressives Volumen. Aus traditionell gefertigten Druckteilen sowie einzelnen Porzellanelementen. Durch den stark gewölbten Reflektor verbreitet die Leuchte ein besonders angenehmes und blendfreies Licht.

Ottakring Wand

<p>Abgebildete Leuchte: Reflektor-Ø 300 mm, aus hochwertigem rostfreiem Aluminium, außen Tiefschwarz (A/S), innen Reinweiß, komplett mit Alu-Wandarm Einrohr senkrecht 300 mm (W130), in die Alu-Gussrossette anschlussfertig verdrahtet</p> <p>Mit hochwertiger Porzellanfassung E27, für Glühlampen bis max. 100 Watt</p>	<p>Reflektor-Ø / Leuchtenhöhe ohne Wandarm</p> <ul style="list-style-type: none"> 200 mm / 200 mm ■ 250 mm / 220 mm ■ 300 mm / 280 mm ■ 350 mm / 325 mm ■ 400 mm / 355 mm 500 mm / 400 mm <p>■ Haupttypen</p> <p>Extras</p> <ul style="list-style-type: none"> • E40 für Glühlampen bis 1000 Watt bei Ø 500 mm <p>Sonderausführungen auf Anfrage</p>	<p>Einrohrige Alu-Wandarme auch als Ecktype möglich (Best.-Nr. + Eck)</p>  <p>Rosette der Kupfer-Varianten</p> 	 E27  E27  E40 <p>CE 230 V 50 Hz</p> <p>IP 20 Außenbereich</p> <p>  elektrische Bauteile geprüft</p>
--	---	---	--

Materialien - Oberflächen

Aluminium beschichtet / lackiert



Tiefschwarz
A/S



Reinweiß, RAL 9010
A/W

Sonderlackierung in RAL-Farbtönen möglich

Aluminium natur



ohne Lackierung
A/R



Klarlack matt
A/M



Klarlack glänzend
A/G

Kupfer natur

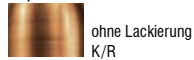

ohne Lackierung
K/R

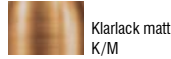

Klarlack matt
K/M

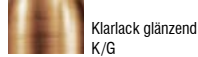

Klarlack glänzend
K/G

Länge Best.-Nr. Wandarmausführungen

300 mm	W330
350 mm	W335
■ 400 mm	W340
■ 450 mm	W345
■ 500 mm	W350
600 mm	W360
700 mm	W370



Doppelrohr senkrecht (nur Aluminium)

■ 300 mm	W130
■ 350 mm	W135
■ 400 mm	W140
■ 450 mm	W145
■ 500 mm	W150
600 mm	W160
700 mm	W170



Einrohr senkrecht

■ 370 mm	W1600
----------	-------



Einrohr geschwungen groß

■ Haupttypen



Eine klassisch-elegante Leuchte mit Gelenk, gewölbtem Schirm und opalem Schraubglas in Kugelform. Aus traditionell gefertigten Guss- und Druckteilen sowie einzelnen Porzellanelementen. Durch das hochwertige Zahngelenk ist ihr Neigungswinkel flexibel. Besonders in der tiefschwarzen Variante besticht sie durch die Harmonie von Form und Farbe.

Retz Kugel Gelenk Wand

<p>Abgebildete Leuchte: Reflektor-Ø 260 mm, aus hochwertigem rostfreiem Aluminium, außen Tiefschwarz (A/S), innen Reinweiß, opales Kugelglas bis 100 Watt, vernickeltes Zahngelenk, in die Alu-Gussrossette anschlussfertig verdrahtet</p> <p>Mit hochwertiger Porzellanfassung E27, für Glühlampen bis max. 60/100 Watt</p>	<p>Reflektor-Ø 260 mm</p> <p>Glas-Ø / Leuchtenhöhe mit Rosette 160 mm / 295 mm (max. 60 Watt) 180 mm / 325 mm (max. 100 Watt)</p> <p>Sonderausführungen auf Anfrage</p>	<p>Auch als Ecktype möglich (Best.-Nr. +Eck)</p>  <p>Rosette der Kupfer-Varianten</p> 	 E27  E27  230 V 50 Hz  IP 20 überdachter Außenbereich   elektrische Bauteile geprüft
---	---	---	--

Materialien - Oberflächen

Aluminium beschichtet / lackiert

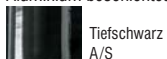

Tiefschwarz
A/S



Reinweiß, RAL 9010
A/W

Sonderlackierung in RAL-Farbtönen möglich

Aluminium natur



ohne Lackierung
A/R



Klarlack matt
A/M

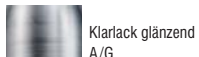

Klarlack glänzend
A/G

Kupfer natur

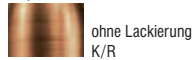

ohne Lackierung
K/R

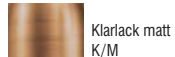

Klarlack matt
K/M



Klarlack glänzend
K/G

Zahngelenk



Messing poliert
Z/MP



Messing vernickelt
Z/MN

Eine klassisch-elegante Leuchte mit gewölbtem Schirm, opalenem Schraubglas in Kugelform und Wandarm.

Aus traditionell gefertigten Guss- und Drückteilen sowie einzelnen Porzellanelementen. Besonders in der tiefschwarzen Variante besticht sie durch die Harmonie von Form und Farbe.



Retz Kugel Wand

<p>Abgebildete Leuchte: Reflektor-Ø 260 mm, aus hochwertigem rostfreiem Aluminium, außen Tiefschwarz (A/S), innen Reinweiß, opalenes Kugelglas bis 100 Watt, komplett mit Alu-Wandarm Einrohr geschwungen 220 mm (W1500), in die Alu-Gussrosette anschlussfertig verdrahtet</p> <p>Mit hochwertiger Porzellanfassung E27, für Glühlampen bis max. 60/100 Watt</p>	<p>Reflektor-Ø 260 mm</p> <p>Glas-Ø / Leuchtenhöhe ohne Wandarm 160 mm / 200 mm (max. 60 Watt) 180 mm / 230 mm (max. 100 Watt)</p> <p>Sonderausführungen auf Anfrage</p>	<p>Einrohrige Alu-Wandarme auch als Ecktype möglich (Best.-Nr.+Eck)</p> 	 E27  E27
		<p>Rosette der Kupfer-Varianten</p> 	<p>CE 230 V 50 Hz</p> <p>IP 54 Außenbereich</p> <p>  elektrische Bauteile geprüft</p>

Materialien - Oberflächen

Aluminium beschichtet / lackiert

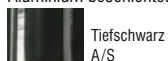

Sonderlackierung in RAL-Farbtönen möglich

Aluminium natur

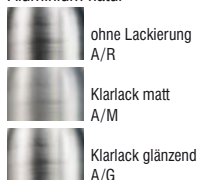

Kupfer natur



Länge Best.-Nr. Wandarmausführungen

- 300 mm W330
- 350 mm W335
- 400 mm W340
- 450 mm W345
- 500 mm W350
- 600 mm W360
- 700 mm W370



Doppelrohr senkrecht (nur Aluminium)

- 300 mm W130
- 350 mm W135
- 400 mm W140
- 450 mm W145
- 500 mm W150
- 600 mm W160
- 700 mm W170



Einrohr senkrecht

- 370 mm W1600

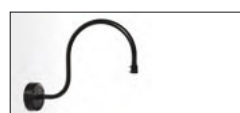

Einrohr geschwungen groß

■ Haupttypen

Länge Best.-Nr. Wandarmausführungen

- 300 mm W430
- 350 mm W435
- 400 mm W440
- 450 mm W445
- 500 mm W450
- 600 mm W460
- 700 mm W470



Doppelrohr schräg (nur Aluminium)

- 300 mm W230
- 350 mm W235
- 400 mm W240
- 450 mm W245
- 500 mm W250
- 600 mm W260
- 700 mm W270



Einrohr schräg

- 220 mm W1500



Einrohr geschwungen klein

■ Haupttypen



Eine schlichte Leuchte mit Gelenk, gewölbtem Schirm und Schraubglas in Zylinderform.

Aus traditionell gefertigten Guss- und Drückteilen sowie einzelnen Porzellanelementen. Durch das hochwertige Zahngelenk ist ihr Neigungswinkel flexibel. Besonders in der tiefschwarzen Variante besticht sie durch ihre Klarheit in Form und Farbe.

Retz Zylinder Gelenk Wand

<p>Abgebildete Leuchte: Reflektor-Ø 260 mm, aus hochwertigem rostfreiem Aluminium, außen Tiefschwarz (A/S), innen Reinweiß, klares Zylinderglas bis 100 Watt, vernickeltes Zahngelenk, in die Alu-Gussrosette anschlussfertig verdrahtet</p> <p>Mit hochwertiger Porzellanfassung E27, für Glühlampen bis max. 60/100 Watt</p>	<p>Reflektor-Ø 260 mm</p> <p>Glas-Ø / Leuchtenhöhe mit Rosette 100 mm / 295 mm (max. 60 Watt) 110 mm / 325 mm (max. 100 Watt)</p> <p>Extras • Zylinderglas auch in Matt lieferbar</p> <p>Sonderausführungen auf Anfrage</p>	<p>Auch als Ecktype möglich (Best.-Nr. + Eck)</p>  <p>Rosette der Kupfer-Varianten</p> 	 E27  E27  230 V 50 Hz  IP 20 überdächter Außenbereich    elektrische Bauteile geprüft
---	--	--	---

Materialien - Oberflächen

Aluminium beschichtet / lackiert



Tiefschwarz
A/S



Reinweiß, RAL 9010
A/W

Sonderlackierung in RAL-Farbtönen möglich

Aluminium natur



ohne Lackierung
A/R



Klarlack matt
A/M



Klarlack glänzend
A/G

Kupfer natur



ohne Lackierung
K/R



Klarlack matt
K/M



Klarlack glänzend
K/G

Zahngelenk



Messing poliert
Z/MP



Messing vernickelt
Z/MN

Eine schlichte Leuchte mit gewölbtem Schirm, Schraubglas in Zylinderform und Wandarm.
 Aus traditionell gefertigten Guss- und Drückteilen sowie einzelnen Porzellanelementen. Besonders in der tiefschwarzen Variante besticht sie durch ihre Klarheit in Form und Farbe.



Retz Zylinder Wand

<p>Abgebildete Leuchte: Reflektor-Ø 260 mm, aus hochwertigem rostfreiem Aluminium, außen Tiefschwarz (A/S), innen Reinweiß, klares Zylinderglas bis 60 Watt, komplett mit Alu-Wandarm Einrohr geschwungen 370 mm (W1600), in die Alu-Gussrosette anschlussfertig verdrahtet</p> <p>Mit hochwertiger Porzellanfassung E27, für Glühlampen bis max. 60/100 Watt</p>	<p>Reflektor-Ø 260 mm</p> <p>Glas-Ø / Leuchtenhöhe ohne Wandarm 100 mm / 200 mm (max. 60 Watt) 110 mm / 230 mm (max. 100 Watt)</p> <p>Extras • Zylinderglas auch in Matt lieferbar</p> <p>Sonderausführungen auf Anfrage</p>	<p>Einrohrige Alu-Wandarme auch als Ecktype möglich (Best.-Nr.+Eck)</p> 	  <p>E27 E27</p>
		<p>Rosette der Kupfer-Varianten</p> 	<p>CE 230 V 50 Hz</p> <p> IP 54 Außenbereich</p> <p>  elektrische Bauteile geprüft</p>

Materialien - Oberflächen

Aluminium beschichtet / lackiert

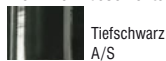

Sonderlackierung in RAL-Farbtönen möglich

Aluminium natur

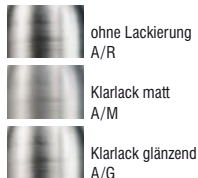

Kupfer natur



Länge Best.-Nr. Wandarmausführungen

- 300 mm W330
- 350 mm W335
- 400 mm W340
- 450 mm W345
- 500 mm W350
- 600 mm W360
- 700 mm W370



- 300 mm W130
- 350 mm W135
- 400 mm W140
- 450 mm W145
- 500 mm W150
- 600 mm W160
- 700 mm W170

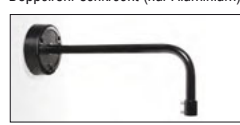

- 370 mm W1600

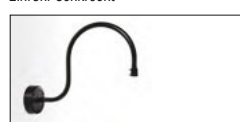

■ Haupttypen

Länge Best.-Nr. Wandarmausführungen

- 300 mm W430
- 350 mm W435
- 400 mm W440
- 450 mm W445
- 500 mm W450
- 600 mm W460
- 700 mm W470

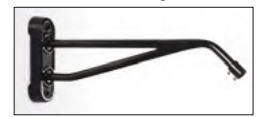

- 300 mm W230
- 350 mm W235
- 400 mm W240
- 450 mm W245
- 500 mm W250
- 600 mm W260
- 700 mm W270

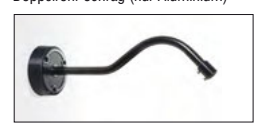

- 220 mm W1500



■ Haupttypen



Eine schlichte einflammige Leuchte mit bewährter Standardleuchtstoffröhre als Wandleuchte montiert. Eine der ersten Neonleuchten aus traditionell gefertigten Metallkomponenten. Durch ihre außergewöhnliche Formensprache ist sie überall dort gefragt, wo ein außergewöhnlicher Akzent zu setzen ist. In großen Räumen kommt sie ganz besonders in stringenter Reihung zur Geltung.

Lugeck I Wand

<p>Abgebildete Leuchte: Leuchte 20 Watt, Metallteile aus veredeltem Stahlblech, Rohre Ø 16 mm, Tiefschwarz (S/S), Elektrik mit verlustarmem Vorschaltgerät und Starter in Wandhalterung</p>	<p>Leuchtenlänge / Röhrenlänge 900 mm / 590 mm (20 Watt) 1510 mm / 1200 mm (40 Watt) 1810 mm / 1500 mm (65 Watt)</p> <p>Wandhalterung 500 x 60 x 30 mm</p> <p>Gesamt-Leuchentiefe 220 mm</p> <p>Extras</p> <ul style="list-style-type: none"> • Elektronische Vorschaltgeräte • Die Leuchtstoffröhre T12, Ø 38 mm, Warmton, kann mitbestellt werden <p>Sonderausführungen auf Anfrage</p>	<p>Originalausführung</p>  <p>Fassungshülse für Leuchtstoffröhre T12, Ø 38 mm</p> <p>Optional bestellbar</p>  <p>Fassungshülse für Leuchtstoffröhre T8, Ø 26 mm</p>	 <p>T8 T12</p> <p>CE 230 V 50 Hz</p> <p>IP 20</p> <p>elektrische Bauteile geprüft</p>
--	---	---	--

Materialien - Oberflächen

Stahlblech beschichtet / lackiert

 Tiefschwarz
S/S

 Reinweiß, RAL 9010
S/W

Sonderlackierung in RAL-Farbtönen möglich

Stahlblech natur

 Klarlack matt
S/M

 Klarlack glänzend
S/G

Eine schlichte zweiflämmige Leuchte mit bewährter Standardleuchtstoffröhre als Deckenleuchte montiert. Eine der ersten Neonleuchten aus traditionell gefertigten Metallkomponenten. Durch ihre außergewöhnliche Formensprache ist sie überall dort gefragt, wo ein außergewöhnlicher Akzent zu setzen ist. In großen Räumen kommt sie ganz besonders in stringenter Reihung zur Geltung.



Lugeck Wand II

<p>Abgebildete Leuchte: Leuchte T12 (2 x 20 Watt), Metallteile aus veredeltem Stahlblech, Röhre Ø 16 mm, Tiefschwarz (S/S), Elektrik mit verlustarmem Vorschaltgerät und Starter in Rechteckgehäuse als Decken-/Wandhalterung</p>	<p>Leuchtenlänge / Röhrenlänge (T12/T8) 820 mm / 590 mm (2 x 20/18 Watt) 1430 mm / 1200 mm (2 x 40/36 Watt) 1730 mm / 1500 mm (2 x 65/58 Watt)</p> <p>Rechteckgehäuse 500 x 60 x 35 mm (2 x 20/18 Watt) 730 x 60 x 35 mm (2 x 40/36 Watt) 730 x 60 x 35 mm (2 x 65/58 Watt)</p> <p>Gesamt-Leuchtenhöhe 85 mm</p> <p>Extras</p> <ul style="list-style-type: none"> • mit elektronischen Vorschaltgeräten (EVGs), auch Dim.1-10 Volt oder Dali-Dim. möglich • Die Leuchtstoffröhren T12, Ø 38 mm können mitbestellt werden <p>Sonderausführungen auf Anfrage</p>	<p>Mannheim II D/W montiert als Wandleuchte</p>  <p>Optional bestellbar Fassungshülse für Leuchtstoffröhre T8, Ø 26 mm</p> 	 <p>T8 T12</p> <p>CE 230 V 50 Hz</p> <p> IP 20</p> <p>  elektrische Bauteile geprüft</p>
--	--	---	--

Materialien - Oberflächen

Stahlblech beschichtet / lackiert



Tiefschwarz
S/S



Reinweiß, RAL 9010
S/W

Sonderlackierung in RAL-Farbtönen möglich

Stahlblech natur



Klarlack matt
S/M



Klarlack glänzend
S/G



Eine schlichte zweiflämmige Leuchte mit bewährter Standardleuchtstoffröhre als Wandleuchte montiert. Eine der ersten Neonleuchten aus traditionell gefertigten Metallkomponenten. Durch ihre außergewöhnliche Formensprache ist sie überall dort gefragt, wo ein außergewöhnlicher Akzent zu setzen ist. In großen Räumen kommt sie ganz besonders in stringenter Reihung zur Geltung.

Lugeck L Wand

<p>Abgebildete Leuchte: Leuchte 2 x 20 Watt, Metallteile aus veredeltem Stahlblech, Röhre Ø 16 mm, Tiefschwarz (S/S), Elektrik mit verlustarmem Vorschaltgerät und Starter in Wandhalterung</p>	<p>Leuchtenlänge / Röhrenlänge 1500 mm / 590 mm (2 x 20 Watt)</p> <p>Wandhalterung 750 x 60 x 30 mm</p> <p>Gesamt-Leuchtentiefe 220 mm</p> <p>Extras</p> <ul style="list-style-type: none"> • Elektronische Vorschaltgeräte • Die Leuchtstoffröhren T12, Ø 38 mm, Warmton, können mitbestellt werden <p>Sonderausführungen auf Anfrage</p>	<p>Originalausführung</p>  <p>Fassungshülse für Leuchtstoffröhre T12, Ø 38 mm</p> <p>Optional bestellbar</p>  <p>Fassungshülse für Leuchtstoffröhre T8, Ø 26 mm</p>	 <p>T8 T12</p> <p>CE 230 V 50 Hz</p> <p>IP 20</p> <p>elektrische Bauteile geprüft</p>
--	--	---	--

Materialien - Oberflächen

Stahlblech beschichtet / lackiert

 Tiefschwarz
S/S

 Reinweiß, RAL 9010
S/W

Sonderlackierung in RAL-Farbtönen möglich

Stahlblech natur

 Klarlack matt
S/M

 Klarlack glänzend
S/G



Eine schlichte dreiflämmige Leuchte mit bewährter Standardleuchtstoffröhre als Wandleuchte montiert. Eine der ersten Neonleuchten aus traditionell gefertigten Metallkomponenten. Durch ihre außergewöhnliche Formensprache ist sie überall dort gefragt, wo ein außergewöhnlicher Akzent zu setzen ist. In großen Räumen kommt sie ganz besonders in stringenter Reihung zur Geltung.

Lugeck XL Wand

<p>Abgebildete Leuchte: Leuchte 3 x 20 Watt, Metallteile aus veredeltem Stahlblech, Röhre Ø 16 mm, Tiefschwarz (S/S), Elektrik mit verlustarmem Vorschaltgerät und Starter in Wandhalterung</p>	<p>Leuchtenlänge / Röhrenlänge 2200 mm / 590 mm (3 x 20 Watt)</p> <p>Wandhalterung 750 x 60 x 30 mm</p> <p>Gesamt-Leuchtentiefe 220 mm</p> <p>Extras</p> <ul style="list-style-type: none"> • Elektronische Vorschaltgeräte • Die Leuchtstoffröhren T12, Ø 38 mm, Warmton, können mitbestellt werden <p>Sonderausführungen auf Anfrage</p>	<p>Originalausführung</p>  <p>Fassungshülse für Leuchtstoffröhre T12, Ø 38 mm</p> <p>Optional bestellbar</p>  <p>Fassungshülse für Leuchtstoffröhre T8, Ø 26 mm</p>	 <p>T8 T12</p>  <p>CE 230 V 50 Hz IP 20 VDE elektrische Bauteile geprüft</p>
--	--	---	--

Materialien - Oberflächen

Stahlblech beschichtet / lackiert

 Tiefschwarz
S/S

 Reinweiß, RAL 9010
S/W

Sonderlackierung in RAL-Farbtönen möglich

Stahlblech natur

 Klarlack matt
S/M

 Klarlack glänzend
S/G



Die formschöne Leuchte mit Halbkugel-Reflektor, runder Kuppel und Wandarm zeigt eindrucksvoll, was in der handwerklichen Formtechnik möglich ist. Aus traditionell gefertigten Druckteilen sowie einzelnen Porzellanelementen. Das reiche Wechselspiel von Halbkugel-, Zylinder- und Kegelelementen macht die Leuchte zu einem typischen Vertreter des jungen 20. Jahrhunderts.

Murau Aufbau Wand

<p>Abgebildete Leuchte: Reflektor-Ø 315 mm, aus hochwertigem rostfreiem Aluminium, außen Tiefschwarz (A/S), innen Reinweiß, komplett mit Alu-Wandarm Doppelrohr. Bild vorn: senkrecht 400 mm (W340), Bild hinten: schräg 400 mm (W440), in die Alu-Gussrosette anschlussfertig verdrahtet</p> <p>Mit hochwertiger Porzellanfassung E27, für Glühlampen bis max. 100 Watt</p>	<p>Reflektor-Ø / Leuchtenhöhe ohne Wandarm 315 mm / 220 mm</p> <p>Sonderausführungen auf Anfrage</p>	<p>Einrohrige Alu-Wandarme auch als Ecktype möglich (Best.-Nr. + Eck)</p> <p>Rosette der Kupfer-Varianten</p>	  <p>E27 E27</p> <p>CE 230 V 50 Hz</p> <p>IP 20 Außenbereich</p> <p>elektrische Bauteile geprüft</p>
---	---	---	---

Materialien - Oberflächen

Aluminium beschichtet / lackiert

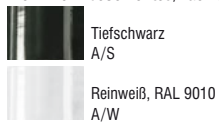

Sonderlackierung in RAL-Farbtönen möglich

Aluminium natur

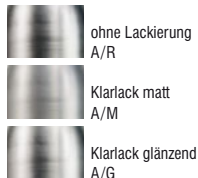

Kupfer natur



Länge Best.-Nr. Wandarmausführungen

- 300 mm W330
- 350 mm W335
- 400 mm W340
- 450 mm W345
- 500 mm W350
- 600 mm W360
- 700 mm W370



Doppelrohr senkrecht (nur Aluminium)

- 300 mm W130
- 350 mm W135
- 400 mm W140
- 450 mm W145
- 500 mm W150
- 600 mm W160
- 700 mm W170



Einrohr senkrecht

- 370 mm W1600

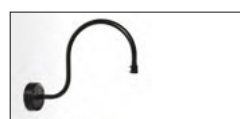

Einrohr geschwungen groß

■ Haupttypen

Länge Best.-Nr. Wandarmausführungen

- 300 mm W430
- 350 mm W435
- 400 mm W440
- 450 mm W445
- 500 mm W450
- 600 mm W460
- 700 mm W470

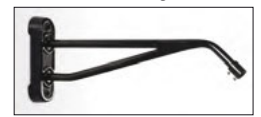

Doppelrohr schräg (nur Aluminium)

- 300 mm W230
- 350 mm W235
- 400 mm W240
- 450 mm W245
- 500 mm W250
- 600 mm W260
- 700 mm W270

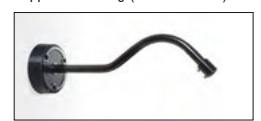

Einrohr schräg

- 220 mm W1500



Einrohr geschwungen klein







■ Haupttypen



Eine kraftvolle Leuchte mit rundlichem Schirm, Breitzylinder-Glas und Wandarm.

Aus traditionell gefertigten Guss- und Drückteilen sowie einzelnen Porzellanelementen. Der harmonische Übergang vom weichen Schirm zum geschwungenen Ansatz des Breitzylinder-Glases verleiht ihr ein stimmiges Äußeres.

Wels Breitzylinder Wand

<p>Abgebildete Leuchte: Reflektor-Ø 450 mm, aus hochwertigem rostfreiem Aluminium, außen Tiefschwarz (A/S), innen Reinweiß, klares Breitzylinder-Glas, komplett mit Alu-Wandarm Doppelrohr senkrecht 400 mm (W340), in die Alu-Gussrosette anschlussfertig verdrahtet</p> <p>Mit hochwertiger Porzellanfassung E27, für Glühlampen bis max. 100 Watt</p>	<p>Reflektor-Ø / Leuchtenhöhe ohne Wandarm 450 mm / 370 mm</p> <p>Glas-Ø / Glashöhe 260 mm / 200 mm</p> <p>Extras • Breitzylinder-Glas auch opalen lieferbar</p> <p>Sonderausführungen auf Anfrage</p>	<p>Einrohrige Alu-Wandarme auch als Ecktype möglich (Best.-Nr. + Eck)</p> 	  <p>E27 E27</p>
		<p>Rosette der Kupfer-Varianten</p> 	<p>CE 230 V 50 Hz</p> <p> IP 20 Außenbereich</p> <p>  elektrische Bauteile geprüft</p>

Materialien - Oberflächen

Aluminium beschichtet / lackiert



Tiefschwarz
A/S



Reinweiß, RAL 9010
A/W

Sonderlackierung in RAL-Farbtönen möglich

Aluminium natur



ohne Lackierung
A/R



Klarlack matt
A/M



Klarlack glänzend
A/G

Kupfer natur



ohne Lackierung
K/R



Klarlack matt
K/M



Klarlack glänzend
K/G

Länge Best.-Nr. Wandarmausführungen

300 mm	W330
350 mm	W335
400 mm	W340
450 mm	W345
500 mm	W350
600 mm	W360
700 mm	W370



Doppelrohr senkrecht (nur Aluminium)

300 mm	W130
350 mm	W135
400 mm	W140
450 mm	W145
500 mm	W150
600 mm	W160
700 mm	W170



Einrohr senkrecht

370 mm	W1600
--------	-------

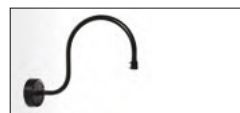

Einrohr geschwungen groß

■ Haupttypen



Eine elegante Leuchte mit rundlichem Schirm, opalenem Kugelglas und Wandarm.

Aus traditionell gefertigten Guss- und Drückteilen sowie einzelnen Porzellanelementen. Das Spiel der Rundungen von Schirm und Kugelglas verleiht der Leuchte ihr unverkennbares Äußeres.

Wels Kugel Wand

<p>Abgebildete Leuchte: Reflektor-Ø 450 mm, aus hochwertigem rostfreiem Aluminium, außen Tiefschwarz (A/S), innen Reinweiß, opalenes Kugelglas, komplett mit Alu-Wandarm Doppelrohr senkrecht 400 mm (W340), in die Alu-Gussrosette anschlussfertig verdrahtet</p> <p>Mit hochwertiger Porzellanfassung E27, für Glühlampen bis max. 100/200 Watt</p>	<p>Reflektor-Ø / Leuchtenhöhe ohne Wandarm 350 mm / 270 mm 450 mm / 310 mm</p> <p>Glas-Ø / Glashöhe 180 mm / 180 mm (max. 100 Watt) 215 mm / 215 mm (max. 200 Watt)</p> <p>Sonderausführungen auf Anfrage</p>	<p>Einrohrige Alu-Wandarme auch als Ecktype möglich (Best.-Nr. + Eck)</p> <p>Rosette der Kupfer-Varianten</p>	  <p>E27 E27</p> <p>CE 230 V 50 Hz</p> <p> IP 54 Außenbereich</p> <p>  elektrische Bauteile geprüft</p>
--	---	---	--

Materialien - Oberflächen

Aluminium beschichtet / lackiert



Tiefschwarz
A/S



Reinweiß, RAL 9010
A/W

Sonderlackierung in RAL-Farbtönen möglich

Aluminium natur



ohne Lackierung
A/R



Klarlack matt
A/M



Klarlack glänzend
A/G

Kupfer natur



ohne Lackierung
K/R



Klarlack matt
K/M



Klarlack glänzend
K/G

Länge Best.-Nr. Wandarmausführungen

300 mm	W330
350 mm	W335
400 mm	W340
450 mm	W345
500 mm	W350
600 mm	W360
700 mm	W370



Doppelrohr senkrecht (nur Aluminium)

300 mm	W130
350 mm	W135
400 mm	W140
450 mm	W145
500 mm	W150
600 mm	W160
700 mm	W170



Einrohr senkrecht

370 mm	W1600
--------	-------

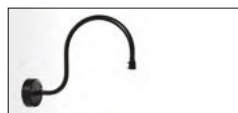

Einrohr geschwungen groß





■ Haupttypen



Eine vornehme Leuchte mit rundlichem Schirm, Spitzzyylinder-Glas und Wandarm.

Aus traditionell gefertigten Guss- und Drückteilen sowie einzelnen Porzellanelementen. Besonders der Kontrast zwischen der weichen Form des Schirms und dem kantigeren Spitzzyylinder-Glas verleiht ihr das außergewöhnliche Äußere.

Wels Spitzzyylinder Wand

<p>Abgebildete Leuchte: Reflektor-Ø 450 mm, aus hochwertigem rostfreiem Aluminium, außen Tiefschwarz (A/S), innen Reinweiß, opalenes Spitzzyylinder-Glas, komplett mit Alu-Wandarm Doppelrohr senkrecht 400 mm (W340), in die Alu-Gussrosette anschlussfertig verdrahtet</p> <p>Mit hochwertiger Porzellanfassung E27, für Glühlampen bis max. 100 Watt</p>	<p>Reflektor-Ø / Leuchtenhöhe ohne Wandarm 450 mm / 410 mm</p> <p>Glas-Ø / Glashöhe 220 mm / 240 mm</p> <p>Extras • Spitzzyylinder-Glas auch in Klar lieferbar</p> <p>Sonderausführungen auf Anfrage</p>	<p>Einrohrige Alu-Wandarme auch als Ecktype möglich (Best.-Nr.+Eck)</p> <p>Rosette der Kupfer-Varianten</p>	  <p>E27 E27</p> <p>CE 230 V 50 Hz</p> <p>IP 20 Außenbereich</p> <p>  elektrische Bauteile geprüft</p>
--	---	---	---

Materialien - Oberflächen

Aluminium beschichtet / lackiert



Tiefschwarz
A/S



Reinweiß, RAL 9010
A/W

Sonderlackierung in RAL-Farbtönen möglich

Aluminium natur



ohne Lackierung
A/R



Klarlack matt
A/M



Klarlack glänzend
A/G

Kupfer natur



ohne Lackierung
K/R



Klarlack matt
K/M



Klarlack glänzend
K/G

Länge Best.-Nr. Wandarmausführungen

300 mm	W330
350 mm	W335
400 mm	W340
450 mm	W345
500 mm	W350
600 mm	W360
700 mm	W370



Doppelrohr senkrecht (nur Aluminium)

300 mm	W130
350 mm	W135
400 mm	W140
450 mm	W145
500 mm	W150
600 mm	W160
700 mm	W170



Einrohr senkrecht

370 mm	W1600
--------	-------

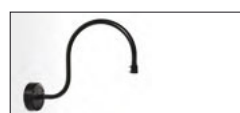







Einrohr geschwungen groß

■ Haupttypen



Die formschöne Leuchte mit Halbkugel-Schirm, runder Kuppel und Wandarm zeichnet sich aus durch ausdrucksstarke Formen und homogene Oberflächen.
Aus traditionell gefertigten Drückteilen sowie einzelnen Porzellanelementen.
Wie bei vielen ihrer Geschwister erlaubt ihr zeitloses Design einen besonders vielseitigen Einsatz.

Spittelberg Wand

<p>Abgebildete Leuchte: Reflektor-Ø 350 mm, aus hochwertigem rostfreiem Aluminium, außen Tiefschwarz (A/S), innen Reinweiß, komplett mit Alu-Wandarm Doppelrohr senkrecht 400 mm (W340), in die Alu-Gussrossette anschlussfertig verdrahtet</p> <p>Mit hochwertiger Porzellanfassung E27, für Glühlampen bis max. 100 Watt</p>	<p>Reflektor-Ø / Leuchtenhöhe ohne Wandarm</p> <p>300 mm / 180 mm 350 mm / 210 mm 400 mm / 250 mm</p>	<p>Einrohrige Alu-Wandarme auch als Ecktype möglich (Best.-Nr. + Eck)</p> 	 E27  E27
<p>Sonderausführungen auf Anfrage</p>		<p>Rosette der Kupfer-Varianten</p> 	<p>CE 230 V 50 Hz</p> <p>IP 20 Außenbereich</p> <p>  elektrische Bauteile geprüft</p>

Materialien - Oberflächen

Aluminium beschichtet / lackiert



Sonderlackierung in RAL-Farbtönen möglich

Aluminium natur

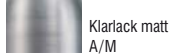

Kupfer natur

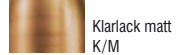

Länge Best.-Nr. Wandarmausführungen

300 mm	W330
350 mm	W335
400 mm	W340
450 mm	W345
500 mm	W350
600 mm	W360
700 mm	W370



300 mm	W130
350 mm	W135
400 mm	W140
450 mm	W145
500 mm	W150
600 mm	W160
700 mm	W170



370 mm	W1600
--------	-------



■ Haupttypen



Eine elegante Leuchte mit flachem Schirm, opalem Schraubglas in Kugelform und Wandarm. Aus traditionell gefertigten Guss- und Drückteilen. Die eigenwillige Schichtung der in der Drück- und Sickenstechnik gearbeiteten Kubatur, verleiht ihr ein besonders extravagantes Äußeres.

Salzburg Kugel Wand

<p>Abgebildete Leuchte: Reflektor-Ø 350 mm, aus hochwertigem rostfreiem Aluminium, außen Tiefschwarz (A/S), innen Reinweiß, opales Kugelglas, komplett mit Alu-Wandarm Doppelrohr senkrecht 400 mm (W340), in die Alu-Gussrossette anschlussfertig verdrahtet</p> <p>Mit hochwertiger Porzellanfassung E27, für Glühlampen bis max. 100 Watt</p>	<p>Reflektor-Ø / Leuchtenhöhe ohne Wandarm 300 mm / 320 mm 350 mm / 320 mm 400 mm / 320 mm</p> <p>Glas-Ø / Glashöhe 180 mm / 180 mm</p> <p>Sonderausführungen auf Anfrage</p>	<p>Einrohrige Alu-Wandarme auch als Ecktype möglich (Best.-Nr. + Eck)</p> 	  <p>E27 E27</p>
		<p>Rosette der Kupfer-Varianten</p> 	<p>CE 230 V 50 Hz</p> <p> IP 54 Außenbereich</p> <p>  elektrische Bauteile geprüft</p>

Materialien - Oberflächen

Aluminium beschichtet / lackiert

 Tiefschwarz A/S

 Reinweiß, RAL 9010 A/W

Sonderlackierung in RAL-Farbtönen möglich

Aluminium natur

 ohne Lackierung A/R

 Klarlack matt A/M

 Klarlack glänzend A/G

Kupfer natur

 ohne Lackierung K/R

 Klarlack matt K/M

 Klarlack glänzend K/G

Länge Best.-Nr. Wandarmausführungen

300 mm W330
350 mm W335
400 mm W340
450 mm W345
500 mm W350
600 mm W360
700 mm W370



300 mm W130
350 mm W135
400 mm W140
450 mm W145
500 mm W150
600 mm W160
700 mm W170



370 mm W1600

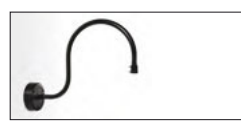

■ Haupttypen

Länge Best.-Nr. Wandarmausführungen

300 mm W430
350 mm W435
400 mm W440
450 mm W445
500 mm W450
600 mm W460
700 mm W470



300 mm W230
350 mm W235
400 mm W240
450 mm W245
500 mm W250
600 mm W260
700 mm W270

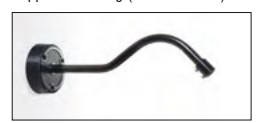

■ Haupttypen



Eine verspielt gearbeitete Leuchte mit flachem Schirm, opalenem Ring-Glas und Wandarm.

Aus traditionell gefertigten Guss- und Drückteilen sowie einzelnen Porzellanelementen. Die eigenwillige Schichtung der in der Drück- und Sockeltechnik gearbeiteten Kubatur verleiht ihr ein besonders extravagantes Äußeres.

Salzburg Ring Wand

<p>Abgebildete Leuchte: Reflektor-Ø 300 mm, aus hochwertigem rostfreiem Aluminium, außen Tiefschwarz (A/S), innen Reinweiß, opalenes Glas, komplett mit Alu-Wandarm Doppelrohr senkrecht 400 mm (W340), in die Alu-Gussrossette anschlussfertig verdrahtet</p> <p>Mit hochwertiger Porzellanfassung E27, für Glühlampen bis max. 100 Watt</p>	<p>Reflektor-Ø / Leuchtenhöhe ohne Wandarm 300 mm / 300 mm 350 mm / 300 mm 400 mm / 300 mm</p> <p>Glas-Ø / Glashöhe 230 mm / 155 mm</p> <p>Sonderausführungen auf Anfrage</p>	<p>Einrohrige Alu-Wandarme auch als Ecktype möglich (Best.-Nr. + Eck)</p> 	 E27  E27
		<p>Rosette der Kupfer-Varianten</p> 	<p>CE 230 V 50 Hz</p> <p>IP 20 Außenbereich</p> <p>elektrische Bauteile geprüft</p>

Materialien - Oberflächen

Aluminium beschichtet / lackiert

Tiefschwarz
A/S

Reinweiß, RAL 9010
A/W

Sonderlackierung in RAL-Farbtönen möglich

Aluminium natur

ohne Lackierung
A/R

Klarlack matt
A/M

Klarlack glänzend
A/G

Kupfer natur

ohne Lackierung
K/R

Klarlack matt
K/M

Klarlack glänzend
K/G

Länge Best.-Nr. Wandarmausführungen

300 mm W330
350 mm W335
400 mm W340
450 mm W345
500 mm W350
600 mm W360
700 mm W370



Doppelrohr senkrecht (nur Aluminium)

300 mm W130
350 mm W135
400 mm W140
450 mm W145
500 mm W150
600 mm W160
700 mm W170



Einrohr senkrecht

370 mm W1600

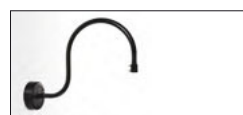

Einrohr geschwungen groß

Haupttypen

Länge Best.-Nr. Wandarmausführungen

300 mm W430
350 mm W435
400 mm W440
450 mm W445
500 mm W450
600 mm W460
700 mm W470



Doppelrohr schräg (nur Aluminium)

300 mm W230
350 mm W235
400 mm W240
450 mm W245
500 mm W250
600 mm W260
700 mm W270











Einrohr schräg

Haupttypen



Eine verspielt gearbeitete Leuchte mit flachem Schirm, opalenem Spitzzylinder-Glas und Wandarm. Aus traditionell gefertigten Guss- und Drückteilen sowie einzelnen Porzellanelementen. Die eigenwillige Schichtung der in der Drück- und Sicken-technik gearbeiteten Kubatur, verleiht ihr ein besonders extravagantes Äußeres.

Salzburg Spitzzylinder Wand

<p>Abgebildete Leuchte: Reflektor-Ø 300 mm, aus hochwertigem rostfreiem Aluminium, außen Tiefschwarz (A/S), innen Reinweiß, opalenes Spitzzylinder-Glas, komplett mit Alu-Wandarm Doppelrohr senkrecht 400 mm (W340), in die Alu-Gussrosette anschlussfertig verdrahtet</p> <p>Mit hochwertiger Porzellanfassung E27, für Glühlampen bis max. 100 Watt</p>	<p>Reflektor-Ø / Leuchtenhöhe ohne Wandarm 300 mm / 300 mm 350 mm / 300 mm 400 mm / 300 mm</p> <p>Glas-Ø / Glashöhe 200 mm / 170 mm</p> <p>Extras • Zylinderglas auch in Klar lieferbar</p> <p>Sonderausführungen auf Anfrage</p>	<p>Einrohrige Alu-Wandarme auch als Ecktype möglich (Best.-Nr. + Eck)</p>  <p>Rosette der Kupfer-Varianten</p> 	 E27  E27  230 V 50 Hz  IP 20  Außenbereich   elektrische Bauteile geprüft
---	--	---	---

Materialien - Oberflächen

Aluminium beschichtet / lackiert

 Tiefschwarz
A/S

 Reinweiß, RAL 9010
A/W

Sonderlackierung in RAL-Farbtönen möglich

Aluminium natur

 ohne Lackierung
A/R

 Klarlack matt
A/M

 Klarlack glänzend
A/G

Kupfer natur

 ohne Lackierung
K/R

 Klarlack matt
K/M

 Klarlack glänzend
K/G

Länge Best.-Nr. Wandarmausführungen

300 mm W330
350 mm W335
400 mm W340
450 mm W345
500 mm W350
600 mm W360
700 mm W370



Doppelrohr senkrecht (nur Aluminium)

300 mm W130
350 mm W135
400 mm W140
450 mm W145
500 mm W150
600 mm W160
700 mm W170



Einrohr senkrecht

370 mm W1600





Einrohr geschwungen groß

■ Haupttypen



Eine verspielt gearbeitete Leuchte mit flachem Schirm, Schraubglas in Zylinderform und Wandarm. Aus traditionell gefertigten Guss- und Drückteilen. Die eigenwillige Schichtung der in der Drück- und Sicketechnik gearbeiteten Kubatur, verleiht ihr ein besonders extravagantes Äußeres.

Salzburg Zylinder Wand

<p>Abgebildete Leuchte: Reflektor-Ø 350 mm, aus hochwertigem rostfreiem Aluminium, außen Tiefschwarz (A/S), innen Reinweiß, klares Zylinderglas, komplett mit Alu-Wandarm Doppelrohr senkrecht 400 mm (W340), in die Alu-Gussrossette anschlussfertig verdrahtet</p> <p>Mit hochwertiger Porzellanfassung E27, für Glühlampen bis max. 100 Watt</p>	<p>Reflektor-Ø / Leuchtenhöhe ohne Wandarm 300 mm / 320 mm 350 mm / 320 mm 400 mm / 320 mm</p> <p>Glas-Ø / Glashöhe 110 mm / 180 mm</p> <p>Extras • Zylinderglas auch in Matt lieferbar</p> <p>Sonderausführungen auf Anfrage</p>	<p>Einrohrige Alu-Wandarme auch als Ecktype möglich (Best.-Nr. + Eck)</p>  <p>Rosette der Kupfer-Varianten</p> 	 E27  E27  230 V 50 Hz  IP 54 Außenbereich   elektrische Bauteile geprüft
--	--	---	---

Materialien - Oberflächen

Aluminium beschichtet / lackiert



Tiefschwarz
A/S



Reinweiß, RAL 9010
A/W

Sonderlackierung in RAL-Farbtönen möglich

Aluminium natur



ohne Lackierung
A/R



Klarlack matt
A/M



Klarlack glänzend
A/G

Kupfer natur



ohne Lackierung
K/R



Klarlack matt
K/M



Klarlack glänzend
K/G

Länge Best.-Nr. Wandarmausführungen

300 mm	W330
350 mm	W335
400 mm	W340
450 mm	W345
500 mm	W350
600 mm	W360
700 mm	W370



300 mm	W130
350 mm	W135
400 mm	W140
450 mm	W145
500 mm	W150
600 mm	W160
700 mm	W170



370 mm	W1600
--------	-------



■ Haupttypen

Länge Best.-Nr. Wandarmausführungen

300 mm	W430
350 mm	W435
400 mm	W440
450 mm	W445
500 mm	W450
600 mm	W460
700 mm	W470



300 mm	W230
350 mm	W235
400 mm	W240
450 mm	W245
500 mm	W250
600 mm	W260
700 mm	W270

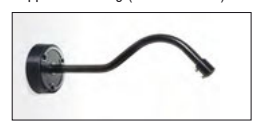

■ Haupttypen



Die Leuchte gehört mit der prägnanten Form des gleichwinkligen Kegelreflektors und Wandarm zu den unverwechselbaren Klassikern. Auch im Aufbau besticht sie durch Kompromisslosigkeit: Sichtbar ist nur der gedrückte Schirm – die Porzellanfassung und das Leuchtmittel treten zurück. Dabei verstärken die durch den Fertigungsprozess bedingten sichtbaren Spuren im Metall den eigenständigen Charakter der Leuchte.

Tuchlauben Wand

<p>Abgebildete Leuchte: Reflektor-Ø 300 mm, aus hochwertigem rostfreiem Aluminium, außen Tiefschwarz (A/S), innen Reinweiß, komplett mit Alu-Wandarm Einrohr senkrecht 300 mm (W130), in die Alu-Gussrossette anschlussfertig verdrahtet</p> <p>Mit hochwertiger Porzellanfassung E27, für Glühlampen bis max. 100 Watt</p>	<p>Reflektor-Ø / Leuchtenhöhe</p> <p>200 mm / 150 mm 250 mm / 190 mm 300 mm / 235 mm 350 mm / 280 mm 400 mm / 320 mm</p> <p>Sonderausführungen auf Anfrage</p>	<p>Einrohrige Alu-Wandarme auch als Ecktype möglich (Best.-Nr. + Eck)</p> 	 E27  E27
		<p>Rosette der Kupfer-Varianten</p> 	<p>CE 230 V 50 Hz</p> <p>IP 20 Außenbereich</p> <p>  elektrische Bauteile geprüft</p>

Materialien - Oberflächen

Aluminium beschichtet / lackiert

Tiefschwarz
A/S

Reinweiß, RAL 9010
A/W

Sonderlackierung in RAL-Farbtönen möglich

Aluminium natur

ohne Lackierung
A/R

Klarlack matt
A/M

Klarlack glänzend
A/G

Kupfer natur

ohne Lackierung
K/R

Klarlack matt
K/M

Klarlack glänzend
K/G

Länge Best.-Nr. Wandarmausführungen

- 300 mm W130
- 350 mm W135
- 400 mm W140
- 450 mm W145
- 500 mm W150
- 600 mm W160
- 700 mm W170



Einrohr senkrecht

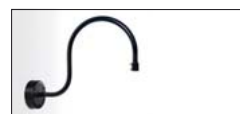

Einrohr geschwungen groß

■ Haupttypen

Länge Best.-Nr. Wandarmausführungen

- 300 mm W230
- 350 mm W235
- 400 mm W240
- 450 mm W245
- 500 mm W250
- 600 mm W260
- 700 mm W270



Einrohr schräg



Einrohr geschwungen klein

■ Haupttypen



Deckenleuchten



Eine universelle Leuchte mit flachem Reflektor und opalem Schraubglas in Kugelform als Deckenleuchte. Aus traditionell gefertigten Guss- und Drückteilen sowie einzelnen Porzellanelementen. Dort, wo noch Wert auf klassische Details gelegt wird, ist sie nicht wegzudenken.

Krems Kugel Decke

<p>Abgebildete Leuchte: Reflektor-Ø 300 mm, aus hochwertigem rostfreiem Aluminium, außen Tiefschwarz (A/S), innen Reinweiß, opales Kugelglas bis 60 Watt, 25 mm Zwischenmuffe, in die Alu-Gussrosette anschlussfertig verdrahtet</p> <p>Mit hochwertiger Porzellanfassung E27, für Glühlampen bis max. 60/100 Watt</p>	<p>Reflektor-Ø 250 mm 300 mm 350 mm 400 mm</p> <p>Glas-Ø / Leuchtenhöhe mit Rosette 160 mm / 255 mm (max. 60 Watt) 180 mm / 285 mm (max. 100 Watt)</p> <p>Extras</p> <ul style="list-style-type: none"> • Auch mit Zwischen-Pendelrohr in Wunschlänge lieferbar <p>Sonderausführungen auf Anfrage</p>	<p>Rosette der Kupfer-Varianten</p> 	 <p>E27 E27</p> <p>CE 230 V 50 Hz</p> <p> IP 54 Außenbereich</p> <p>  elektrische Bauteile geprüft</p>
---	---	--	---

Materialien - Oberflächen

Stahlblech beschichtet / lackiert

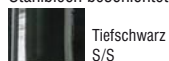

Sonderlackierung in RAL-Farbtönen möglich

Aluminium natur

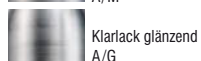



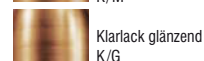
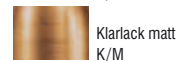
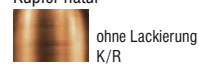



Kupfer natur



Eine universelle Leuchte mit Gelenk, flachem Reflektor und opalemem Schraubglas in Kugelform. Aus traditionell gefertigten Guss- und Drückteilen sowie einzelnen Porzellanelementen. Durch das hochwertige Zahngelenk ist ihr Neigungswinkel flexibel. Dort, wo noch Wert auf klassische Details gelegt wird, ist sie nicht wegzudenken.



Krems Kugel Gelenk Decke

<p>Abgebildete Leuchte: Reflektor-Ø 300 mm, aus hochwertigem rostfreiem Aluminium, außen Tiefschwarz (A/S), innen Reinweiß, opales Kugelglas bis 60 Watt, vernickeltes Zahngelenk, in die Alu-Gussrosette anschlussfertig verdrahtet</p> <p>Mit hochwertiger Porzellanfassung E27, für Glühlampen bis max. 60/100 Watt</p>	<p>Reflektor-Ø 250 mm 300 mm 350 mm 400 mm</p> <p>Glas-Ø / Leuchtenhöhe mit Rosette 160 mm / 295 mm (max. 60 Watt) 180 mm / 325 mm (max. 100 Watt)</p> <p>Sonderausführungen auf Anfrage</p>	<p>Rosette der Kupfer-Varianten mit Zahngelenk Messing poliert</p> 	 E27  E27  230 V 50 Hz  IP 20 überdächter Außenbereich   elektrische Bauteile geprüft
---	--	---	--

Materialien - Oberflächen

Stahlblech beschichtet / lackiert

 Tiefschwarz
S/S

 Reinweiß, RAL 9010
S/W

Sonderlackierung in RAL-Farbtönen möglich

Aluminium natur

 ohne Lackierung
A/R

 Klarlack matt
A/M

 Klarlack glänzend
A/G

Kupfer natur

 ohne Lackierung
K/R

 Klarlack matt
K/M

 Klarlack glänzend
K/G

Zahngelenk

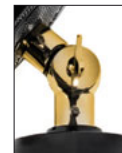

Messing poliert
Z/MP



Messing vernickelt
Z/MN



Eine robuste Leuchte mit flachem Reflektor und Schraubglas in Zylinderform als Deckenleuchte. Aus traditionell gefertigten Guss- und Drückteilen sowie einzelnen Porzellanelementen. Dort, wo noch Wert auf stimmige Details gelegt wird, ist sie nicht wegzudenken.

Krems Zylinder Decke

<p>Abgebildete Leuchte: Reflektor-Ø 300 mm, aus hochwertigem rostfreiem Aluminium, außen Tiefschwarz (A/S), innen Reinweiß, klares Zylinderglas bis 60 Watt, 25 mm Zwischenmuffe, in die Alu-Gussrosette anschlussfertig verdrahtet</p> <p>Mit hochwertiger Porzellanfassung E27, für Glühlampen bis max. 60/100 Watt</p>	<p>Reflektor-Ø 250 mm 300 mm 350 mm 400 mm</p> <p>Glas-Ø / Leuchtenhöhe mit Rosette 100 mm / 255 mm (max. 60 Watt) 110 mm / 285 mm (max. 100 Watt)</p> <p>Extras</p> <ul style="list-style-type: none"> • Auch mit Zwischen-Pendelrohr in Wunschlänge lieferbar • Zylinderglas auch in Matt lieferbar <p>Sonderausführungen auf Anfrage</p>	<p>Rosette der Kupfer-Varianten</p> 	 <p>E27 E27</p>  <p>CE 230 V 50 Hz</p> <p>IP 54 Außenbereich</p>  <p>elektrische Bauteile geprüft</p>
--	--	--	--

Materialien - Oberflächen

Stahlblech beschichtet / lackiert

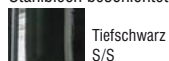

Sonderlackierung in RAL-Farbtönen möglich

Aluminium natur

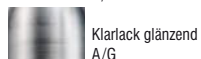

Kupfer natur

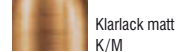
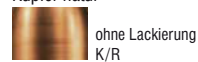









Eine robuste Leuchte mit Gelenk, flachem Reflektor und Schraubglas in Zylinderform.

Aus traditionell gefertigten Guss- und Drückteilen sowie einzelnen Porzellanelementen. Durch das hochwertige Zahngelenk ist ihr Neigungswinkel flexibel. Dort, wo noch Wert auf stimmige Details gelegt wird, ist sie nicht wegzudenken.



Krems Zylinder Gelenk Decke

<p>Abgebildete Leuchte: Reflektor-Ø 350 mm, aus hochwertigem rostfreiem Aluminium, außen Tiefschwarz (A/S), innen Reinweiß, klares Zylinderglas bis 100 Watt, vernickeltes Zahngelenk, in die Alu-Gussrossette anschlussfertig verdrahtet</p> <p>Mit hochwertiger Porzellanfassung E27, für Glühlampen bis max. 60/100 Watt</p>	<p>Reflektor-Ø 250 mm 300 mm 350 mm 400 mm</p> <p>Glas-Ø / Leuchtenhöhe mit Rosette 100 mm / 295 mm (max. 60 Watt) 110 mm / 325 mm (max. 100 Watt)</p> <p>Extras • Zylinderglas auch in Matt lieferbar</p> <p>Sonderausführungen auf Anfrage</p>	<p>Rosette der Kupfer-Varianten mit Zahngelenk Messing poliert</p> 	 E27  E27  230 V 50 Hz  IP 20 überdächter Außenbereich    elektrische Bauteile geprüft
--	---	---	---

Materialien - Oberflächen

Stahlblech beschichtet / lackiert



Tiefschwarz
S/S



Reinweiß, RAL 9010
S/W

Sonderlackierung in RAL-Farbtönen möglich

Aluminium natur



ohne Lackierung
A/R



Klarlack matt
A/M



Klarlack glänzend
A/G

Kupfer natur



ohne Lackierung
K/R



Klarlack matt
K/M



Klarlack glänzend
K/G

Zahngelenk

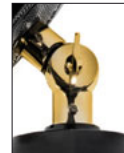

Messing poliert
Z/MP

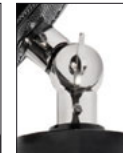

Messing vernickelt
Z/MN



Eine harmonische Funktionsleuchte mit kegelförmigem Gusskopf und opalem Schraubglas in Kugelform als Deckenleuchte.

In ihrer Reduktion auf die nötigsten Elemente besticht sie durch die Klarheit ihrer funktionalen Details.

Pulkau Kugel Decke

<p>Abgebildete Leuchte: Leuchtenkopf aus hochwertigem rostfreiem Aluminium, Tiefschwarz (A/S), opales Kugelglas bis 60 Watt, 25 mm Zwischenmuffe, in die Alu-Gussrosette anschlussfertig verdrahtet</p> <p>Mit hochwertiger Porzellanfassung E27, für Glühlampen bis max. 60/100 Watt</p>	<p>Gusskopf-Ø 105 mm 120 mm</p> <p>Glas-Ø / Leuchtenhöhe mit Rosette 160 mm / 255 mm (max. 60 Watt) 180 mm / 285 mm (max. 100 Watt)</p> <p>Extras</p> <ul style="list-style-type: none"> • Auch mit Zwischen-Pendelrohr in Wunschlänge lieferbar <p>Sonderausführungen auf Anfrage</p>	<p>Rosette der Kupfer-Varianten</p> 	 <p>E27 E27</p> <p>CE 230 V 50 Hz</p> <p> IP 54 Außenbereich</p> <p>  elektrische Bauteile geprüft</p>
--	--	--	--

Materialien - Oberflächen

Stahlblech beschichtet / lackiert

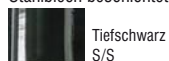

Sonderlackierung in RAL-Farbtönen möglich

Aluminium natur

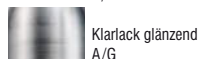



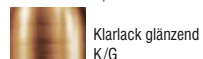
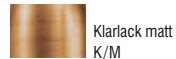
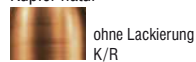



Kupfer natur



Eine harmonische Funktionsleuchte mit Gelenk, kegelförmigem Gusskopf und opalem Schraubglas in Kugelform. Durch das hochwertige Zahngelenk ist ihr Neigungswinkel flexibel. In ihrer Reduktion auf die nötigsten Elemente besticht sie durch die Klarheit ihrer funktionalen Details.



Pulkau Kugel Gelenk Decke

<p>Abgebildete Leuchte: Leuchtenkopf aus hochwertigem rostfreiem Aluminium, Tiefschwarz (A/S), opales Kugelglas bis 100 Watt, vernickeltes Zahngelenk, in die Alu-Gussrosette anschlussfertig verdrahtet</p> <p>Mit hochwertiger Porzellanfassung E27, für Glühlampen bis max. 60/100 Watt</p>	<p>Gusskopf-Ø 105 mm 120 mm</p> <p>Glas-Ø / Leuchtenhöhe mit Rosette 160 mm / 295 mm (max. 60 Watt) 180 mm / 325 mm (max. 100 Watt)</p> <p>Sonderausführungen auf Anfrage</p>	<p>Rosette der Kupfer-Varianten mit Zahngelenk Messing poliert</p> 	 E27  E27  230 V 50 Hz  IP 20 überdächter Außenbereich   elektrische Bauteile geprüft
---	---	---	--

Materialien - Oberflächen

Stahlblech beschichtet / lackiert



Tiefschwarz
S/S



Reinweiß, RAL 9010
S/W

Sondertackierung in RAL-Farbtönen möglich

Aluminium natur



ohne Lackierung
A/R



Klarlack matt
A/M



Klarlack glänzend
A/G

Kupfer natur



ohne Lackierung
K/R



Klarlack matt
K/M



Klarlack glänzend
K/G

Zahngelenk

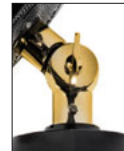

Messing poliert
Z/MP



Messing vernickelt
Z/MN



Eine einfache Funktionsleuchte mit kegelförmigem Gusskopf und Schraubglas in Zylinderform als Deckenleuchte.
In ihrer Reduktion auf die nötigsten Elemente besticht sie durch die Klarheit ihrer funktionalen Details.

Pulkau Zylinder Decke

<p>Abgebildete Leuchte: Leuchtenkopf aus hochwertigem rostfreiem Aluminium, Tiefschwarz (A/S), klares Zylinderglas bis 60 Watt, 25 mm Zwischenmuffe, in die Alu-Gussrosette anschlussfertig verdrahtet</p> <p>Mit hochwertiger Porzellanfassung E27, für Glühlampen bis max. 60/100 Watt</p>	<p>Gusskopf-Ø 105 mm 120 mm</p> <p>Glas-Ø / Leuchtenhöhe mit Rosette 100 mm / 255 mm (max. 60 Watt) 110 mm / 285 mm (max. 100 Watt)</p> <p>Extras</p> <ul style="list-style-type: none"> • Auch mit Zwischen-Pendelrohr in Wunschlänge lieferbar • Zylinderglas auch in Matt lieferbar <p>Sonderausführungen auf Anfrage</p>	<p>Rosette der Kupfer-Varianten</p> 	 <p>E27 E27</p> <p>CE 230 V 50 Hz</p> <p>IP 54 Außenbereich</p> <p>  elektrische Bauteile geprüft</p>
---	---	--	--

Materialien - Oberflächen

Stahlblech beschichtet / lackiert

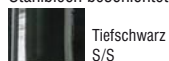

Sonderlackierung in RAL-Farbtönen möglich

Aluminium natur

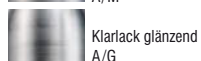



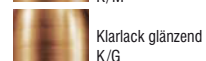
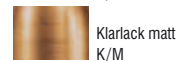
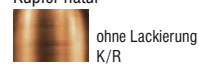



Kupfer natur



Eine einfache Funktionsleuchte mit Gelenk, kegelförmigem Gusskopf und Schraubglas in Zylinderform. Durch das hochwertige Zahngelenk ist ihr Neigungswinkel flexibel. In ihrer Reduktion auf die nötigsten Elemente besticht sie durch die Klarheit ihrer funktionalen Details.



Pulkau Zylinder Gelenk Decke

<p>Abgebildete Leuchte: Leuchtenkopf aus hochwertigem rostfreiem Aluminium, Tiefschwarz (A/S), klares Zylinderglas bis 60 Watt, vernickeltes Zahngelenk, in die Alu-Gussrosette anschlussfertig verdrahtet</p> <p>Mit hochwertiger Porzellanfassung E27, für Glühlampen bis max. 60/100 Watt</p>	<p>Gusskopf-Ø 105 mm 120 mm</p> <p>Glas-Ø / Leuchtenhöhe mit Rosette 100 mm / 295 mm (max. 60 Watt) 110 mm / 325 mm (max. 100 Watt)</p> <p>Extras • Zylinderglas auch in Matt lieferbar</p> <p>Sonderausführungen auf Anfrage</p>	<p>Rosette der Kupfer-Varianten mit Zahngelenk Messing poliert</p> 	 E27  E27  230 V 50 Hz  IP 20 überdächter Außenbereich   elektrische Bauteile geprüft
---	--	---	--

Materialien - Oberflächen

Stahlblech beschichtet / lackiert



Tiefschwarz
S/S



Reinweiß, RAL 9010
S/W

Sonderlackierung in RAL-Farbtönen möglich

Aluminium natur



ohne Lackierung
A/R



Klarlack matt
A/M



Klarlack glänzend
A/G

Kupfer natur



ohne Lackierung
K/R



Klarlack matt
K/M



Klarlack glänzend
K/G

Zahngelenk



Messing poliert
Z/MP



Messing vernickelt
Z/MN



Eine funktionale Leuchte mit angeschnittenem Kegelschirm. Aus traditionell gefertigten Guss- und Drückteilen sowie einzelnen Porzellanelementen. Wie viele andere Zweckleuchten hat die ehemalige Schrankenbeleuchtung ihren ganz besonderen Charme.

Bregenz Decke

<p>Abgebildete Leuchte: Reflektorgröße 350 mm x 290 mm, aus veredeltem Stahlblech, außen Tiefschwarz (S/S), innen Reinweiß, 25 mm Zwischenmuffe, in die Alu-Gussrosette anschlussfertig verdrahtet</p> <p>Mit hochwertiger Porzellanfassung E27, für Glühlampen bis max. 100 Watt</p>	<p>Reflektoröffnung 280 mm x 230 mm = Typ 306 350 mm x 290 mm = Typ 307</p> <p>Leuchtenhöhe mit Rosette 400 mm = Typ 306 450 mm = Typ 307</p> <p>Extras</p> <ul style="list-style-type: none"> • Auch mit Zwischen-Pendelrohr in Wunschlänge lieferbar <p>Sonderausführungen auf Anfrage</p>	<p>Rosette der Kupfer-Varianten</p> 	 <p>E27 E27</p> <p>CE 230 V 50 Hz</p> <p> IP 20 Außenbereich</p> <p>  elektrische Bauteile geprüft</p>
--	--	--	---

Materialien - Oberflächen

Stahlblech beschichtet / lackiert



Tiefschwarz
S/S



Reinweiß, RAL 9010
S/W

Sonderlackierung in RAL-Farbtönen möglich

Aluminium natur



ohne Lackierung
A/R



Klarlack matt
A/M



Klarlack glänzend
A/G

Stahlblech natur



Klarlack matt
S/M



Klarlack glänzend
S/G

Kupfer natur



ohne Lackierung
K/R



Klarlack matt
K/M









Klarlack glänzend
K/G



Eine funktionale Leuchte mit angeschnittenem Kegelschirm. Aus traditionell gefertigten Guss- und Drückteilen sowie einzelnen Porzellanelementen. Durch das hochwertige Zahngelenk ist ihr Neigungswinkel flexibel. Wie viele andere Zweckleuchten hat die ehemalige Schrankenbeleuchtung ihren ganz besonderen Charme.

Bregenz Gelenk Decke

<p>Abgebildete Leuchte: Reflektorgröße 350 mm x 290 mm, aus veredeltem Stahlblech, außen Tiefschwarz (S/S), innen Reinweiß, vernickeltes Zahngelenk, in die Alu-Gussrosette anschlussfertig verdrahtet</p> <p>Mit hochwertiger Porzellanfassung E27, für Glühlampen bis max. 100 Watt</p>	<p>Reflektoröffnung 280 mm x 230 mm = Typ 306 350 mm x 290 mm = Typ 307</p> <p>Leuchtenhöhe mit Rosette (bei Deckenmontage und senkrechtem Reflektor) 445 mm = Typ 306 495 mm = Typ 307</p> <p>Sonderausführungen auf Anfrage</p>	<p>Rosette der Kupfer-Varianten mit Zahngelenk Messing poliert</p> 	 E27  E27  230 V 50 Hz  IP 20 überdächter Außenbereich   elektrische Bauteile geprüft
--	---	---	--

Materialien - Oberflächen

Stahlblech beschichtet / lackiert



Tiefschwarz
S/S



Reinweiß, RAL 9010
S/W

Sonderlackierung in RAL-Farbtönen möglich

Aluminium natur



ohne Lackierung
A/R



Klarlack matt
A/M



Klarlack glänzend
A/G

Stahlblech natur



Klarlack matt
S/M



Klarlack glänzend
S/G

Kupfer natur



ohne Lackierung
K/R



Klarlack matt
K/M



Klarlack glänzend
K/G

Zahngelenk

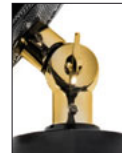

Messing poliert
Z/MP



Messing vernickelt
Z/MN



Eine klassisch-elegante Leuchte mit gewölbtem Schirm und opalenem Schraubglas in Kugelform als Deckenleuchte.

Aus traditionell gefertigten Guss- und Drückteilen sowie einzelnen Porzellanelementen. Besonders in der tiefschwarzen Variante besticht sie durch die Harmonie von Form und Farbe.

Retz Kugel Decke

<p>Abgebildete Leuchte: Reflektor-Ø 260 mm, aus hochwertigem rostfreiem Aluminium, außen Tiefschwarz (A/S), innen Reinweiß, opalenes Kugelglas bis 60 Watt, 25 mm Zwischenmuffe, in die Alu-Gussrosette anschlussfertig verdrahtet</p> <p>Mit hochwertiger Porzellanfassung E27, für Glühlampen bis max. 60/100 Watt</p>	<p>Reflektor-Ø 260 mm</p> <p>Glas-Ø / Leuchtenhöhe mit Rosette 160 mm / 255 mm (max. 60 Watt) 180 mm / 285 mm (max. 100 Watt)</p> <p>Extras</p> <ul style="list-style-type: none"> • Auch mit Zwischen-Pendelrohr in Wunschlänge lieferbar <p>Sonderausführungen auf Anfrage</p>	<p>Rosette der Kupfer-Varianten</p> 	 <p>E27 E27</p> <p>CE 230 V 50 Hz</p> <p>IP 54 Außenbereich</p> <p>elektrische Bauteile geprüft</p>
---	--	--	--

Materialien - Oberflächen

Stahlblech beschichtet / lackiert



Tiefschwarz
S/S



Reinweiß, RAL 9010
S/W

Sonderlackierung in RAL-Farbtönen möglich

Aluminium natur



ohne Lackierung
A/R



Klarlack matt
A/M



Klarlack glänzend
A/G

Kupfer natur



ohne Lackierung
K/R



Klarlack matt
K/M



Klarlack glänzend
K/G

Eine klassisch-elegante Leuchte mit Gelenk, gewölbtem Schirm und opalemem Schraubglas in Kugelform. Aus traditionell gefertigten Guss- und Drückteilen sowie einzelnen Porzellanelementen. Durch das hochwertige Zahngelenk ist ihr Neigungswinkel flexibel. Besonders in der tiefschwarzen Variante besticht sie durch die Harmonie von Form und Farbe.



Retz Kugel Gelenk Decke

<p>Abgebildete Leuchte: Reflektor-Ø 260 mm, aus hochwertigem rostfreiem Aluminium, außen Tiefschwarz (A/S), innen Reinweiß, opales Kugelglas bis 100 Watt, vernickeltes Zahngelenk, in die Alu-Gussrosette anschlussfertig verdrahtet</p> <p>Mit hochwertiger Porzellanfassung E27, für Glühlampen bis max. 60/100 Watt</p>	<p>Reflektor-Ø 260 mm</p> <p>Glas-Ø / Leuchtenhöhe mit Rosette 160 mm / 295 mm (max. 60 Watt) 180 mm / 325 mm (max. 100 Watt)</p> <p>Sonderausführungen auf Anfrage</p>	<p>Rosette der Kupfer-Varianten mit Zahngelenk Messing poliert</p> 	 E27  E27  230 V 50 Hz  IP 20 überdachter Außenbereich   elektrische Bauteile geprüft
--	---	---	--

Materialien - Oberflächen

Stahlblech beschichtet / lackiert

 Tiefschwarz
S/S

 Reinweiß, RAL 9010
S/W

Sondertackierung in RAL-Farbtönen möglich

Aluminium natur

 ohne Lackierung
A/R

 Klarlack matt
A/M

 Klarlack glänzend
A/G

Kupfer natur

 ohne Lackierung
K/R

 Klarlack matt
K/M

 Klarlack glänzend
K/G

Zahngelenk

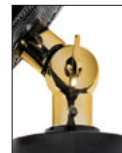

Messing poliert
Z/MP



Messing vernickelt
Z/MN



Eine schlichte Leuchte mit gewölbtem Schirm und Schraubglas in Zylinderform als Deckenleuchte. Aus traditionell gefertigten Guss- und Drückteilen sowie einzelnen Porzellanelementen. Besonders in der tiefschwarzen Variante besticht sie durch ihre Klarheit in Form und Farbe.

Retz Zylinder Decke

<p>Abgebildete Leuchte: Reflektor-Ø 260 mm, aus hochwertigem rostfreiem Aluminium, außen Tiefschwarz (A/S), innen Reinweiß, klares Zylinderglas bis 60 Watt, 25 mm Zwischenmuffe, in die Alu-Gussrosette anschlussfertig verdrahtet</p> <p>Mit hochwertiger Porzellanfassung E27, für Glühlampen bis max. 60/100 Watt</p>	<p>Reflektor-Ø 260 mm</p> <p>Glas-Ø / Leuchtenhöhe mit Rosette 100 mm / 255 mm (max. 60 Watt) 110 mm / 285 mm (max. 100 Watt)</p> <p>Extras</p> <ul style="list-style-type: none"> • Auch mit Zwischen-Pendelrohr in Wunschlänge lieferbar • Zylinderglas auch in Matt lieferbar <p>Sonderausführungen auf Anfrage</p>	<p>Rosette der Kupfer-Varianten</p> 	 <p>E27 E27</p> <p>CE 230 V 50 Hz</p> <p>IP 54 Außenbereich</p> <p>  elektrische Bauteile geprüft</p>
--	---	--	--

Materialien - Oberflächen

Stahlblech beschichtet / lackiert

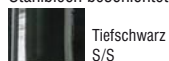

Sonderlackierung in RAL-Farbtönen möglich

Aluminium natur

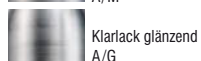

Kupfer natur

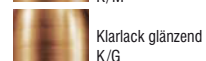
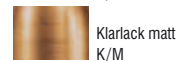
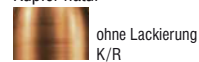







Eine schlichte Leuchte mit Gelenk, gewölbtem Schirm und Schraubglas in Zylinderform.

Aus traditionell gefertigten Guss- und Drückteilen sowie einzelnen Porzellanelementen. Durch das hochwertige Zahngelenk ist ihr Neigungswinkel flexibel. Besonders in der tiefschwarzen Variante besticht sie durch ihre Klarheit in Form und Farbe.



Retz Zylinder Gelenk Decke

<p>Abgebildete Leuchte: Reflektor-Ø 260 mm, aus hochwertigem rostfreiem Aluminium, außen Tiefschwarz (A/S), innen Reinweiß, klares Zylinderglas bis 100 Watt, vernickeltes Zahngelenk, in die Alu-Gussrossette anschlussfertig verdrahtet</p> <p>Mit hochwertiger Porzellanfassung E27, für Glühlampen bis max. 60/100 Watt</p>	<p>Reflektor-Ø 260 mm</p> <p>Glas-Ø / Leuchtenhöhe mit Rosette 100 mm / 295 mm (max. 60 Watt) 110 mm / 325 mm (max. 100 Watt)</p> <p>Extras • Zylinderglas auch in Matt lieferbar</p> <p>Sonderausführungen auf Anfrage</p>	<p>Rosette der Kupfer-Varianten mit Zahngelenk Messing poliert</p> 	 E27  E27  230 V 50 Hz  IP 20 überdächter Außenbereich   elektrische Bauteile geprüft
--	--	---	---

Materialien - Oberflächen

Stahlblech beschichtet / lackiert



Tiefschwarz
S/S



Reinweiß, RAL 9010
S/W

Sonderlackierung in RAL-Farbtönen möglich

Aluminium natur



ohne Lackierung
A/R



Klarlack matt
A/M



Klarlack glänzend
A/G

Kupfer natur



ohne Lackierung
K/R



Klarlack matt
K/M



Klarlack glänzend
K/G

Zahngelenk

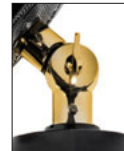

Messing poliert
Z/MP



Messing vernickelt
Z/MN



Die flache Deckenleuchte, zusammengesetzt aus einem als Drückteil gefertigten Grundkörper und dem gewölbten, ätzmatten Echtglas der Hängeleuchte Potsdam. Durch sichtbare Schrauben ist sie mit dem Zeitgeist des jungen 20. Jahrhunderts verbunden. Durch ihre elegante Form eignet sie sich besonders zu Repräsentationszwecken sowohl in privaten als auch in öffentlichen Räumlichkeiten.

Heiligenstadt Decke

<p>Abgebildete Leuchte: Grundkörper aus Messing natur (M/R) mit ätzmattem Glas</p> <p>Mit hochwertiger Porzellanfassung E27, für Glühlampen bis max. 100 Watt</p>	<p>Leuchten-Ø / Leuchtenhöhe 330 mm / 140 mm</p> <p>Extras</p> <ul style="list-style-type: none"> • Auch für Bestückung mit Ringröhre T9 22 Watt mit EVG lieferbar <p>Sonderausführungen auf Anfrage</p>	<p>Die Leuchte ist auch als Wandtype montierbar</p> 	 E27  E27  T9-FC  230 V 50 Hz   IP 20   elektrische Bauteile geprüft
--	---	--	--

Materialien - Oberflächen

Stahlblech beschichtet / lackiert



Tiefschwarz
S/S



Reinweiß, RAL 9010
S/W

Sonderlackierung in RAL-Farbtönen möglich

Messing natur



ohne Lackierung
M/R

Stahlblech natur



Klarlack matt
S/M



Klarlack glänzend
S/G

Stahlblech verchromt



verchromt
S/C

Kupfer mit Patina



Patina
K/P

Die formschöne Leuchte mit drei Halbkugel-Reflektoren und runden Kuppeln zeigt eindrucksvoll, was in der handwerklichen Formtechnik möglich ist. Aus traditionell gefertigten Druckteilen sowie einzelnen Porzellanelementen. Durch die hochwertigen Zahngelenke ist ihr Neigungswinkel flexibel.



Murau III Decke

<p>Abgebildete Leuchte: Reflektor-Ø 315 mm, aus veredeltem Stahlblech, außen Tiefschwarz (S/S), innen Reinweiß, Schraubverbindungen und Zahngelenke Messing poliert (Z/MP), je 500 mm Pendelrohre Ø 16 mm, in massiven Stahlblech-Baldachin anschlussfertig verdrahtet</p> <p>Mit hochwertiger Porzellanfassung E27, für Glühlampen bis max. 100 Watt</p>	<p>Reflektor-Ø / Leuchtenhöhe 315 mm / 220 mm</p> <p>Gesamt-Ø / Leuchtenhöhe 1300 mm / 500 mm</p>	<p>Massiver Stahlblech-Baldachin Ø 250 mm</p> 	 <p>E27 E27</p>  <p>CE 230 V 50 Hz</p> <p>IP 20</p>  <p>elektrische Bauteile geprüft</p>
Sonderausführungen auf Anfrage			

Materialien - Oberflächen

Stahlblech beschichtet / lackiert

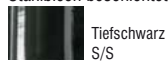

Sonderlackierung in RAL-Farbtönen möglich

Aluminium natur

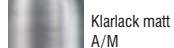

Stahlblech natur

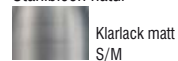

Kupfer natur

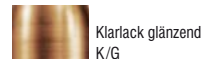
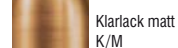
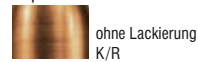

Aufhängungen: Kabel/Kupferkette

Zahngelenk



Messing poliert
Z/MP



Messing vernickelt
Z/MN



Standleuchten

Eine klassische Leuchte mit Reflektor in abgeflachter Kegelform als Deckenfluter.
 Aus traditionell gefertigten Guss- und Drückteilen sowie einzelnen Porzellanelementen. In großen Räumen verbreitet sie durch ihre breite, flache Form ein angenehm großflächiges und gleichmäßiges Deckenlicht.



Sievering Fluter

<p>Abgebildete Leuchte: Reflektor-Ø 400 mm, aus hochwertigem Aluminium natur, allseits mit Klarlack matt geschützt (A/M), Alu-Stab-Ø 25 mm, aluverkleideter Gusseisenfuß, schwarzes Textil-Kabel (TS) 1,5 m lang mit Zwischenschalter und Schukostecker, Leuchten-Gesamthöhe 1400 mm</p> <p>Mit hochwertiger Porzellanfassung E27, für Glühlampen bis max. 100 Watt</p>	<p>Reflektor-Ø / Reflektorhöhe 250 mm / 190 mm 450 mm / 330 mm 300 mm / 210 mm 500 mm / 350 mm 350 mm / 240 mm 600 mm / 365 mm 400 mm / 280 mm</p> <p>Leuchten-Gesamthöhe / Fuß-Ø 1400 mm / 400 mm 1600 mm / 400 mm 1800 mm / 400 mm</p> <p>Extras • E40 für Glühlampen bis 1000 Watt bei Ø 500 mm, Ø 600 mm</p> <p>Sonderausführungen auf Anfrage</p>	<p>Individuelle Struktur durch Handarbeit</p>	<p>E27 E27</p> <p>E40</p> <p>CE 230 V 50 Hz</p> <p>IP 20</p> <p>elektrische Bauteile geprüft</p>
---	--	---	---

Materialien - Oberflächen

Stahlblech beschichtet / lackiert

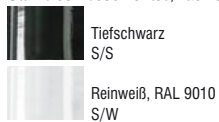

Sonderlackierung in RAL-Farbtönen möglich

Aluminium natur

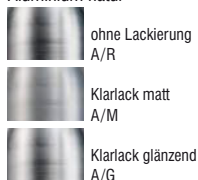

Stahlblech natur



Kupfer natur



Kabelvarianten

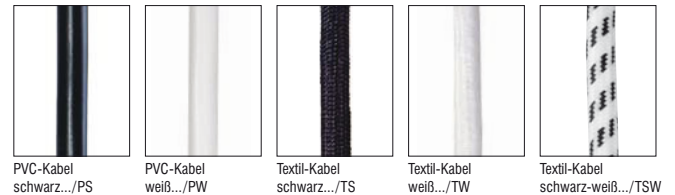





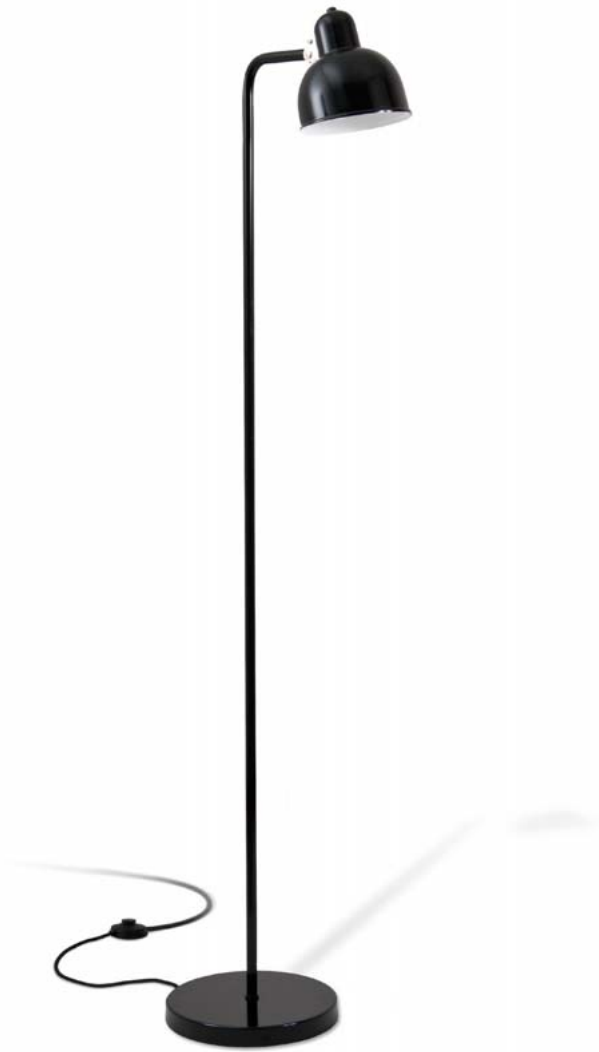

Die für ihre Zeit typische Standleuchte mit schräg beschnittenem Reflektor legt als reduzierte Funktionsleuchte ihren Schwerpunkt auf einfache Formen und Fügungen.

Aus traditionell gefertigten Drückteilen sowie einzelnen Porzellanelementen. Auch wenn es nichts gibt, was nicht einer eindeutigen Funktion folgt, besticht diese Standleuchte gerade durch die Klarheit ihrer Form und Fertigung.



Penzing Stand

<p>Abgebildete Leuchte: Reflektor-Ø 150 mm, aus veredeltem Stahlblech, außen Tiefschwarz (S/S), innen Reinweiß, Gelenkteile vernickelt, Stahlrohr-Ø 16 mm, stahlblechverkleideter Gusseisenfuß Ø 250 mm, schwarzes Textil-Kabel (TS) 1,5 m lang mit Zwischenschalter und Schukostecker, Leuchten-Gesamthöhe 1800 mm</p> <p>Mit hochwertiger Porzellanfassung E27, für Glühlampen bis max. 100 Watt</p>	<p>Reflektor-Ø / Reflektorhöhe 150 mm 150 mm</p> <p>Leuchten-Gesamthöhe 1400 mm 1800 mm 1600 mm 2000 mm</p> <p>Extras • Sonderlänge des Standrohres auf Wunsch</p> <p>Sonderausführungen auf Anfrage</p>	 <p>Stahlblechverkleideter Gusseisenfuß</p>	 E27  E27  230 V 50 Hz  IP 20   elektrische Bauteile geprüft
---	--	---	---

Materialien - Oberflächen

Stahlblech beschichtet / lackiert



Tiefschwarz
S/S



Reinweiß, RAL 9010
S/W

Sonderlackierung in RAL-Farbtönen möglich

Aluminium natur



ohne Lackierung
A/R



Klarlack matt
A/M



Klarlack glänzend
A/G

Stahlblech natur



Klarlack matt
S/M



Klarlack glänzend
S/G

Kupfer natur



ohne Lackierung
K/R



Klarlack matt
K/M



Klarlack glänzend
K/G

Kabelvarianten



PVC-Kabel
schwarz.../PS



PVC-Kabel
weiß.../PW



Textil-Kabel
schwarz.../TS



Textil-Kabel
weiß.../TW



















Textil-Kabel
schwarz-weiß.../TSW

Eine funktionale Leuchte mit angeschnittenem Kegelschirm als Standleuchte.
 Aus traditionell gefertigten Guss- und Drückteilen mit geschwungenem Bogenarm.
 Wie viele andere Zweckleuchten hat die ehemalige Schrankenbeleuchtung ihren ganz besonderen Charme.



Innsbruck Gelenk Stand

<p>Abgebildete Leuchte: Reflektorgröße 280 mm x 230 mm, aus veredeltem Stahlblech, außen Tiefschwarz (S/S), innen Reinweiß, Zahngelenk Messing poliert (Z/MP), Halbrundbogen Ø 230 mm, Stahlrohr-Ø 16 mm, stahleblechverkleideter Gusseisenfuß Ø 250 mm, schwarzes Textil-Kabel (TS) 1,5 m lang mit Zwischenschalter und Schukostecker, Leuchten-Gesamthöhe 1800 mm</p> <p>Mit hochwertiger Porzellanfassung E27, für Glühlampen bis max. 100 Watt</p>	<p>Reflektor-Ø / Reflektorhöhe 280 mm x 230 mm = Typ 306 350 mm x 290 mm = Typ 307</p> <p>Leuchten-Gesamthöhe 1400 mm 1800 mm 1600 mm 2000 mm</p> <p>Extras • Sonderlänge des Standrohres auf Wunsch</p> <p>Sonderausführungen auf Anfrage</p>	<p>Durch hochwertiges Zahngelenk verstellbar</p> 	<table border="1"> <tr> <td> E27</td> <td> E27</td> </tr> <tr> <td></td> <td>230 V 50 Hz</td> </tr> <tr> <td></td> <td>IP 20</td> </tr> <tr> <td colspan="2"> elektrische Bauteile geprüft</td> </tr> </table>	 E27	 E27		230 V 50 Hz		IP 20	 elektrische Bauteile geprüft	
 E27	 E27										
	230 V 50 Hz										
	IP 20										
 elektrische Bauteile geprüft											

Materialien - Oberflächen

Stahlblech beschichtet / lackiert



Sonderlackierung in RAL-Farbtönen möglich

Aluminium natur

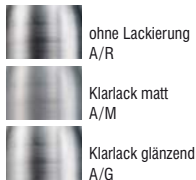

Stahlblech natur



Kupfer natur



Kabelvarianten

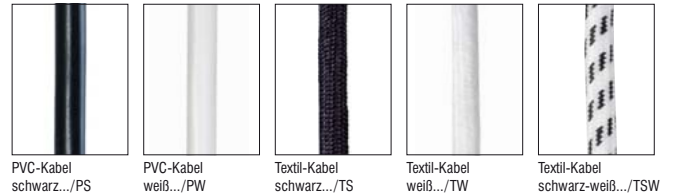

Zahngelenk

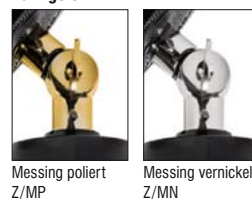

Eine klassische Leuchte mit Reflektor in Halbkugelform als Deckenfluter. Aus traditionell gefertigten Guss- und Drückteilen sowie einzelnen Porzellanelementen. In großen Räumen verbreitet sie durch ihr Volumen und den stark gewölbten Reflektor ein angenehmes und blendfreies Deckenlicht.

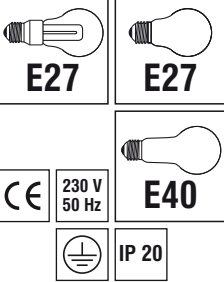

Ottakring Fluter

<p>Abgebildete Leuchte: Reflektor-Ø 350 mm, aus veredeltem Stahlblech, außen Tiefschwarz (S/S), innen Reinweiß, Stahl-Stab-Ø 25 mm, stahlblechverkleideter Gusseisenfuß, schwarz-weißes Textil-Kabel (TSW) 1,5 m lang mit Zwischenschalter und Schukostecker, Leuchten-Gesamthöhe 1800 mm</p> <p>Mit hochwertiger Porzellanfassung E27, für Glühlampen bis max. 100 Watt</p>	<p>Reflektor-Ø / Reflektorhöhe 250 mm / 220 mm 300 mm / 280 mm 350 mm / 325 mm 400 mm / 355 mm 500 mm / 400 mm Haupttypen</p> <p>Leuchten-Gesamthöhe / Fuß-Ø 1400 mm / 400 mm 1600 mm / 400 mm 1800 mm / 400 mm</p> <p>Extras • E40 für Glühlampen bis 1000 Watt bei Ø 500 mm Sonderausführungen auf Anfrage</p>	<p>Individuelle Struktur durch Handarbeit</p> 	 <p>CE 230 V 50 Hz</p> <p>elektrische Bauteile geprüft</p>
---	---	--	---

Materialien - Oberflächen

Stahlblech beschichtet / lackiert

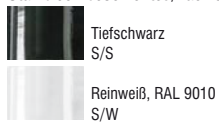

Sonderlackierung in RAL-Farbtönen möglich

Aluminium natur

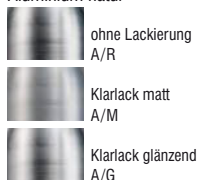

Stahlblech natur



Kupfer natur



Kabelvarianten

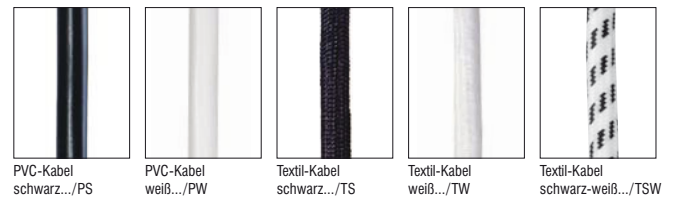

Eine klassische Leuchte mit Reflektor in abgeflachter Kegelform als Standleuchte.

Aus traditionell gefertigten Druckteilen mit geschwungenem Bogenarm. Diese Leuchte zeichnet sich aus durch ihr zeitloses Design sowie ihre akzentuierte Beleuchtung atmosphärischer Gärten und Wege.



Sievering Stand

<p>Abgebildete Leuchte: Reflektor-Ø 350 mm, aus hochwertigem rostfreiem Aluminium, außen Tiefschwarz (A/S), innen Reinweiß, Standrohr aus Stahlrohr und Fußplatte aus Massiv-Eisen, spezialgrundiert und Tiefschwarz (S/S) beschichtet, in Fußplatte anschlussfertig verdrahtet, Leuchten-Gesamthöhe 1400 mm</p> <p>Mit hochwertiger Porzellanfassung E27, für Glühlampen bis max. 100 Watt</p>	<p>Reflektor-Ø / Reflektorhöhe 250 mm / 190 mm 300 mm / 210 mm 350 mm / 240 mm 400 mm / 280 mm</p> <p>Leuchten-Gesamthöhe 1400 mm 1800 mm 1600 mm 2000 mm</p> <p>Haupttypen</p> <p>Sonderausführungen auf Anfrage</p>	<p>Standrohr ausschließlich in Stahl, mit massiver Fußplatte Ø 150 mm verschweißt</p> 	 E27  E27  230 V 50 Hz  IP 20  Außenbereich   elektrische Bauteile geprüft
--	---	--	---

Materialien - Oberflächen des Reflektors

Aluminium beschichtet / lackiert



Tiefschwarz
A/S



Reinweiß, RAL 9010
A/W

Sonderlackierung in RAL-Farbtönen möglich

Aluminium natur



ohne Lackierung
A/R



Klarlack matt
A/M



Klarlack glänzend
A/G

Kupfer natur



ohne Lackierung
K/R



Klarlack matt
K/M



Klarlack glänzend
K/G

Materialien - Oberflächen des Standrohrs

Stahlrohr beschichtet / lackiert



Tiefschwarz
S/S



Reinweiß, RAL 9010
S/W

Sonderlackierung in RAL-Farbtönen möglich



Eine klassische Leuchte mit Reflektor in abgeflachter Kegelform plus opalem Schraubglas in Kugelform als Standleuchte.

Aus traditionell gefertigten Guss- und Drückteilen mit geschwungenem Bogenarm.

Sie zeichnet sich aus durch ihr zeitloses Design und ist mit eingebautem Gusskopf mit Dichtung und Schraubglas spritzwassergeschützt.

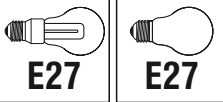

Sievering Kugel Stand

<p>Abgebildete Leuchte: Reflektor-Ø 350 mm, aus hochwertigem rostfreiem Aluminium, außen Tiefschwarz (A/S), innen Reinweiß, opales Kugelglas bis 60 Watt, Standrohr aus Stahlrohr und Fußplatte aus Massiv-Eisen, spezialgrundiert und Tiefschwarz (S/S) beschichtet, in Fußplatte anschlussfertig verdrahtet, Leuchten-Gesamthöhe 1400 mm</p> <p>Mit hochwertiger Porzellanfassung E27, für Glühlampen bis max. 60 Watt</p>	<p>Reflektor-Ø / -höhe mit Glas 350 mm / 285 mm (max. 60 Watt) 400 mm / 305 mm (max. 60 Watt)</p> <p>Glas-Ø 160 mm (max. 60 Watt)</p> <p>Leuchten-Gesamthöhe ■ 1400 mm ■ 1800 mm ■ 1600 mm ■ 2000 mm</p> <p>■ Haupttypen</p> <p>Sonderausführungen auf Anfrage</p>	<p>Standrohr ausschließlich in Stahl, mit massiver Fußplatte Ø 150 mm verschweißt</p> 	 <p>E27 E27</p>  <p>CE 230 V 50 Hz</p> <p>IP 54 Außenbereich</p>  <p>elektrische Bauteile geprüft</p>
---	---	--	---

Materialien - Oberflächen des Reflektors

Aluminium beschichtet / lackiert



Tiefschwarz
A/S



Reinweiß, RAL 9010
A/W

Sonderlackierung in RAL-Farbtönen möglich

Aluminium natur



ohne Lackierung
A/R



Klarlack matt
A/M



Klarlack glänzend
A/G

Kupfer natur



ohne Lackierung
K/R



Klarlack matt
K/M



Klarlack glänzend
K/G

Materialien - Oberflächen des Standrohrs

Stahlrohr beschichtet / lackiert



Tiefschwarz
S/S



Reinweiß, RAL 9010
S/W

Sonderlackierung in RAL-Farbtönen möglich

Eine klassische Leuchte mit Reflektor in abgeflachter Kegelform plus Schraubglas in Zylinderform als Standleuchte.

Aus traditionell gefertigten Guss- und Drückteilen mit geschwungenem Bogenarm.

Sie zeichnet sich aus durch ihr zeitloses Design und ist mit eingebautem Gusskopf mit Dichtung und Schraubglas spritzwassergeschützt.



Sievering Zylinder Stand

<p>Abgebildete Leuchte: Reflektor-Ø 350 mm, aus hochwertigem rostfreiem Aluminium, außen Tiefschwarz (A/S), innen Reinweiß, klares Zylinderglas bis 60 Watt, Standrohr aus Stahlrohr und Fußplatte aus Massiv-Eisen, spezialgrundiert und Tiefschwarz (S/S) beschichtet, in Fußplatte anschlussfertig verdrahtet, Leuchten-Gesamthöhe 1400 mm</p> <p>Mit hochwertiger Porzellanfassung E27, für Glühlampen bis max. 60 Watt</p>	<p>Reflektor-Ø / -höhe mit Glas 350 mm / 285 mm (max. 60 Watt) 400 mm / 305 mm (max. 60 Watt)</p> <p>Glas-Ø 100 mm (max. 60 Watt)</p> <p>Leuchten-Gesamthöhe ■ 1400 mm ■ 1800 mm ■ 1600 mm ■ 2000 mm</p> <p>■ Haupttypen</p> <p>Extras • Zylinderglas auch in Matt lieferbar</p> <p>Sonderausführungen auf Anfrage</p>	<p>Standrohr ausschließlich in Stahl, mit massiver Fußplatte Ø 150 mm verschweißt</p> 	 <p>E27 E27</p>  <p>CE 230 V 50 Hz</p> <p>IP 54 Außenbereich</p>  <p>elektrische Bauteile geprüft</p>
--	--	--	---

Materialien - Oberflächen des Reflektors

Aluminium beschichtet / lackiert



Tiefschwarz
A/S



Reinweiß, RAL 9010
A/W

Sonderlackierung in RAL-Farbtönen möglich

Aluminium natur



ohne Lackierung
A/R



Klarlack matt
A/M



Klarlack glänzend
A/G

Kupfer natur



ohne Lackierung
K/R



Klarlack matt
K/M



Klarlack glänzend
K/G

Materialien - Oberflächen des Standrohrs

Stahlrohr beschichtet / lackiert



Tiefschwarz
S/S



Reinweiß, RAL 9010
S/W

Sonderlackierung in RAL-Farbtönen möglich







Eine universelle Leuchte mit flachem Reflektor und opalem Schraubglas in Kugelform als Standleuchte.

Aus traditionell gefertigten Guss- und Drückteilen mit geschwungenem Bogenarm.

Die universelle Garten-, Hof- und Wegeleuchte ist dort, wo noch Wert auf klassische Details gelegt wird, nicht wegzudenken.



Krems Kugel Stand

<p>Abgebildete Leuchte: Reflektor-Ø 300 mm, aus hochwertigem rostfreiem Aluminium, außen Tiefschwarz (A/S), innen Reinweiß, opales Kugelglas bis 60 Watt, Standrohr aus Stahlrohr und Fußplatte aus Massiv-Eisen, spezialgrundiert und Tiefschwarz (S/S) beschichtet, in Fußplatte anschlussfertig verdrahtet, Leuchten-Gesamthöhe 1400 mm</p> <p>Mit hochwertiger Porzellanfassung E27, für Glühlampen bis max. 60/100 Watt</p>	<p>Reflektor-Ø 250 mm ■ 350 mm 300 mm ■ 400 mm</p> <p>Glas-Ø / Reflektorhöhe mit Glas 160 mm / 200 mm (max. 60 Watt) 180 mm / 230 mm (max. 100 Watt)</p> <p>Leuchten-Gesamthöhe ■ 1400 mm ■ 1800 mm 1600 mm 2000 mm ■ Haupttypen</p> <p>Sonderausführungen auf Anfrage</p>	<p>Standrohr ausschließlich in Stahl, mit massiver Fußplatte Ø 150 mm verschweißt</p> 	 E27  E27
		<p>CE 230 V 50 Hz</p> <p> IP 54 Außenbereich</p> <p>  elektrische Bauteile geprüft</p>	

Materialien - Oberflächen des Reflektors

Aluminium beschichtet / lackiert



Tiefschwarz
A/S



Reinweiß, RAL 9010
A/W

Sonderlackierung in RAL-Farbtönen möglich

Aluminium natur



ohne Lackierung
A/R



Klarlack matt
A/M



Klarlack glänzend
A/G

Kupfer natur



ohne Lackierung
K/R



Klarlack matt
K/M



Klarlack glänzend
K/G

Materialien - Oberflächen des Standrohrs

Stahlrohr beschichtet / lackiert



Tiefschwarz
S/S







Reinweiß, RAL 9010
S/W

Sonderlackierung in RAL-Farbtönen möglich

Eine robuste Leuchte mit flachem Reflektor und Schraubglas in Zylinderform als Standleuchte. Aus traditionell gefertigten Guss- und Drückteilen mit geschwungenem Bogenarm. Ob klassischer Park, Garten oder Gutshof – überall dort, wo noch Wert auf stimmige Details gelegt wird, ist diese Leuchte nicht wegzudenken.

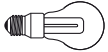

Krems Zylinder Stand

<p>Abgebildete Leuchte: Reflektor-Ø 300 mm, aus hochwertigem rostfreiem Aluminium, außen Tiefschwarz (A/S), innen Reinweiß, klares Zylinderglas bis 60 Watt, Standrohr aus Stahlrohr und Fußplatte aus Massiv-Eisen, spezialgrundiert und Tiefschwarz (S/S) beschichtet, in Fußplatte anschlussfertig verdrahtet, Leuchten-Gesamthöhe 1400 mm</p> <p>Mit hochwertiger Porzellanfassung E27, für Glühlampen bis max. 60/100 Watt</p>	<p>Reflektor-Ø 250 mm ■ 350 mm ■ 300 mm 400 mm</p> <p>Glas-Ø / Reflektorhöhe mit Glas 100 mm / 200 mm (max. 60 Watt) 110 mm / 230 mm (max. 100 Watt)</p> <p>Leuchten-Gesamthöhe ■ 1400 mm ■ 1800 mm 1600 mm 2000 mm ■ Haupttypen</p> <p>Extras • Zylinderglas auch in Matt lieferbar</p> <p>Sonderausführungen auf Anfrage</p>	<p>Standrohr ausschließlich in Stahl, mit massiver Fußplatte Ø 150 mm verschweißt</p> 	 E27  E27
		<p>CE 230 V 50 Hz</p> <p> IP 54 Außenbereich</p> <p>  elektrische Bauteile geprüft</p>	

Materialien - Oberflächen des Reflektors

Aluminium beschichtet / lackiert



Tiefschwarz
A/S



Reinweiß, RAL 9010
A/W

Sonderlackierung in RAL-Farbtönen möglich

Aluminium natur



ohne Lackierung
A/R



Klarlack matt
A/M



Klarlack glänzend
A/G

Kupfer natur



ohne Lackierung
K/R



Klarlack matt
K/M



Klarlack glänzend
K/G

Materialien - Oberflächen des Standrohrs

Stahlrohr beschichtet / lackiert



Tiefschwarz
S/S



Reinweiß, RAL 9010
S/W

Sonderlackierung in RAL-Farbtönen möglich







Eine robuste Leuchte mit zwei flachen Reflektoren und Schraubgläsern in Zylinderform als Standleuchte.

Aus traditionell gefertigten Guss- und Drückteilen mit geschwungenen Bogenarmen.

Ob klassischer Park, Garten oder Gutshof – überall dort, wo noch Wert auf stimmige Details gelegt wird, ist diese Leuchte nicht wegzudenken.



Krems Zylinder II Stand

<p>Abgebildete Leuchte: Reflektoren-Ø 300 mm, aus hochwertigem rostfreiem Aluminium, außen Tiefschwarz (A/S), innen Reinweiß, klare Zylindergläser bis 60 Watt. Standrohr aus Stahlrohr und Fußplatte aus Massiv-Eisen, spezialgrundiert und Tiefschwarz (S/S) beschichtet, in Fußplatte anschlussfertig verdrahtet, Leuchten-Gesamthöhe 1400 mm</p> <p>Mit hochwertiger Porzellanfassung E27, für Glühlampen bis max. 60/100 Watt</p>	<p>Reflektor-Ø 250 mm ■ 350 mm 300 mm ■ 400 mm</p> <p>Glas-Ø / Reflektorhöhe mit Glas 100 mm / 200 mm (max. 60 Watt) 110 mm / 230 mm (max. 100 Watt)</p> <p>Leuchten-Gesamthöhe ■ 1400 mm ■ 1800 mm 1600 mm 2000 mm ■ Haupttypen</p> <p>Extras • Zylinderglas auch in Matt lieferbar</p> <p>Sonderausführungen auf Anfrage</p>	<p>Standrohr ausschließlich in Stahl, mit massiver Fußplatte Ø 150 mm verschweißt</p> 	 E27  E27  230 V 50 Hz  IP 54 Außenbereich   elektrische Bauteile geprüft
---	--	--	---

Materialien - Oberflächen des Reflektors

Aluminium beschichtet / lackiert



Tiefschwarz
A/S



Reinweiß, RAL 9010
A/W

Sonderlackierung in RAL-Farbtönen möglich

Aluminium natur



ohne Lackierung
A/R



Klarlack matt
A/M



Klarlack glänzend
A/G

Kupfer natur



ohne Lackierung
K/R



Klarlack matt
K/M



Klarlack glänzend
K/G

Materialien - Oberflächen des Standrohrs

Stahlrohr beschichtet / lackiert



Tiefschwarz
S/S









Reinweiß, RAL 9010
S/W

Sonderlackierung in RAL-Farbtönen möglich

Eine robuste Leuchte mit drei flachen Reflektoren und Schraubgläsern in Zylinderform als Standleuchte. Aus traditionell gefertigten Guss- und Drückteilen mit geschwungenen Bogenarmen. Ob klassischer Park, Garten oder Gutshof – überall dort, wo noch Wert auf stimmige Details gelegt wird, ist diese Leuchte nicht wegzudenken.



Krems Zylinder III Stand

<p>Abgebildete Leuchte: Reflektoren-Ø 300 mm, aus hochwertigem rostfreiem Aluminium, außen Tiefschwarz (A/S), innen Reinweiß, klare Zylindergläser bis 100 Watt. Standrohr aus Stahlrohr und Fußplatte aus Massiv-Eisen, spezialgrundiert und Tiefschwarz (S/S) beschichtet, in Fußplatte anschlussfertig verdrahtet, Leuchten-Gesamthöhe 1400 mm</p> <p>Mit hochwertiger Porzellanfassung E27, für Glühlampen bis max. 60/100 Watt</p>	<p>Reflektor-Ø 250 mm ■ 350 mm 300 mm ■ 400 mm</p> <p>Glas-Ø / Reflektorhöhe mit Glas 100 mm / 200 mm (max. 60 Watt) 110 mm / 230 mm (max. 100 Watt)</p> <p>Leuchten-Gesamthöhe ■ 1400 mm ■ 1800 mm 1600 mm 2000 mm ■ Haupttypen</p> <p>Extras • Zylinderglas auch in Matt lieferbar</p> <p>Sonderausführungen auf Anfrage</p>	<p>Standrohr ausschließlich in Stahl, mit massiver Fußplatte Ø 150 mm verschweißt</p> 	 E27  E27
		 230 V 50 Hz	 IP 54 Außenbereich
		 VDE elektrische Bauteile geprüft	

Materialien - Oberflächen des Reflektors

Aluminium beschichtet / lackiert



Tiefschwarz
A/S



Reinweiß, RAL 9010
A/W

Sonderlackierung in RAL-Farbtönen möglich

Aluminium natur



ohne Lackierung
A/R



Klarlack matt
A/M



Klarlack glänzend
A/G

Kupfer natur



ohne Lackierung
K/R



Klarlack matt
K/M



Klarlack glänzend
K/G

Materialien - Oberflächen des Standrohrs

Stahlrohr beschichtet / lackiert



Tiefschwarz
S/S



Reinweiß, RAL 9010
S/W

Sonderlackierung in RAL-Farbtönen möglich



















Die Leuchte mit ihrem verspielt geschwungenen Schirm gehört auch als Standleuchte zu unseren besonderen Klassikern.

Aus traditionell gefertigten Druckteilen mit geschwungenem Bogenarm.

Die ausgeprägten Formen der in der Druck- und Sickingentechnik erzeugten Kubaturen verleihen ihr eine ganz besondere Ausdruckskraft.



Schwechat Stand

<p>Abgebildete Leuchte: Reflektor-Ø 350 mm, aus hochwertigem rostfreiem Aluminium, außen Tiefschwarz (A/S), innen Reinweiß, Standrohr aus Stahlrohr und Fußplatte aus Massiv-Eisen, spezialgrundiert und Tiefschwarz (S/S) beschichtet, in Fußplatte anschlussfertig verdrahtet, Leuchten-Gesamthöhe 1400 mm</p> <p>Mit hochwertiger Porzellanfassung E27, für Glühlampen bis max. 100 Watt</p>	<p>Reflektor-Ø / Reflektorhöhe 350 mm / 270 mm</p> <p>Leuchten-Gesamthöhe</p> <table border="0"> <tr> <td>■ 1400 mm</td> <td>■ 1800 mm</td> </tr> <tr> <td>■ 1600 mm</td> <td>■ 2000 mm</td> </tr> </table> <p>■ Haupttypen</p> <p>Sonderausführungen auf Anfrage</p>	■ 1400 mm	■ 1800 mm	■ 1600 mm	■ 2000 mm	<p>Standrohr ausschließlich in Stahl, mit massiver Fußplatte Ø 150 mm verschweißt</p> 	<table border="0"> <tr> <td></td> <td></td> </tr> <tr> <td>E27</td> <td>E27</td> </tr> <tr> <td></td> <td>230 V 50 Hz</td> </tr> <tr> <td></td> <td>IP 20 Außenbereich</td> </tr> <tr> <td></td> <td> elektrische Bauteile geprüft</td> </tr> </table>			E27	E27		230 V 50 Hz		IP 20 Außenbereich		 elektrische Bauteile geprüft
■ 1400 mm	■ 1800 mm																
■ 1600 mm	■ 2000 mm																
																	
E27	E27																
	230 V 50 Hz																
	IP 20 Außenbereich																
	 elektrische Bauteile geprüft																

Materialien - Oberflächen des Reflektors

Aluminium beschichtet / lackiert



Tiefschwarz
A/S



Reinweiß, RAL 9010
A/W

Sonderlackierung in RAL-Farbtönen möglich

Aluminium natur



ohne Lackierung
A/R



Klarlack matt
A/M



Klarlack glänzend
A/G

Kupfer natur



ohne Lackierung
K/R



Klarlack matt
K/M



Klarlack glänzend
K/G

Materialien - Oberflächen des Standrohrs

Stahlrohr beschichtet / lackiert



Tiefschwarz
S/S



Reinweiß, RAL 9010
S/W

Sonderlackierung in RAL-Farbtönen möglich

Die Leuchte mit ihrem eigenwilligen Reflektor und in den Vordergrund tretenden Zylinderglas ist ein besonderer Klassiker der Kollektion EBOLICHT.

Optisch reduziert auf zwei traditionell gefertigte Drückteile mit geschwungenem Bogenarm. Das schlichte Spiel des Doppelreflektors erlaubt es, in unterschiedlichsten Architektursprachen markante und doch zeitlose Akzente zu setzen.



Nußdorf Zylinder Stand

<p>Abgebildete Leuchte: Doppelreflektor-Ø 350 mm, aus hochwertigem rostfreiem Aluminium, außen Tiefschwarz (A/S), Unterseite Reinweiß, mattiertes Zylinderglas bis 100 Watt, Standrohr aus Stahlrohr und Fußplatte aus Massiv-Eisen, spezialgründiert und Tiefschwarz (S/S) beschichtet, in Fußplatte anschlussfertig verdrahtet, Leuchten-Gesamthöhe 1400 mm</p> <p>Mit hochwertiger Porzellanfassung E27, für Glühlampen bis max. 60/100 Watt</p>	<p>Reflektor-Ø 300 mm 350 mm</p> <p>Glas-Ø / Leuchtenhöhe mit Glas 100 mm / 240 mm (max. 60 Watt) 110 mm / 270 mm (max. 100 Watt)</p> <p>Leuchten-Gesamthöhe ■ 1400 mm ■ 1800 mm 1600 mm 2000 mm</p> <p>■ Haupttypen</p> <p>Extras • Zylinderglas auch in Klar lieferbar</p> <p>Sonderausführungen auf Anfrage</p>	<p>Standrohr ausschließlich in Stahl, mit massiver Fußplatte Ø 150 mm verschweißt</p> 	 E27  E27
		 230 V 50 Hz	 IP 54 Außenbereich
		  elektrische Bauteile geprüft	

Materialien - Oberflächen des Reflektors

Aluminium beschichtet / lackiert



Tiefschwarz
A/S



Reinweiß, RAL 9010
A/W

Sonderlackierung in RAL-Farbtönen möglich

Aluminium natur



ohne Lackierung
A/R



Klarlack matt
A/M



Klarlack glänzend
A/G

Kupfer natur



ohne Lackierung
K/R



Klarlack matt
K/M



Klarlack glänzend
K/G

Materialien - Oberflächen des Standrohrs

Stahlrohr beschichtet / lackiert



Tiefschwarz
S/S





Reinweiß, RAL 9010
S/W

Sonderlackierung in RAL-Farbtönen möglich

Die Leuchte mit Halbkugel-Schirm und runder Kuppel als Standleuchte besticht durch ihr expressives Volumen. Aus traditionell gefertigten Druckteilen mit geschwungenem Bogenarm. Durch den stark gewölbten Reflektor verbreitet die Leuchte ein besonders angenehmes und blendfreies Licht.

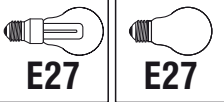
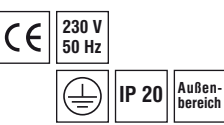

Penzing Stand

<p>Abgebildete Leuchte: Reflektor-Ø 350 mm, aus hochwertigem rostfreiem Aluminium, außen Tiefschwarz (A/S), innen Reinweiß, Standrohr aus Stahlrohr und Fußplatte aus Massiv-Eisen, spezialgrundiert und Tiefschwarz (S/S) beschichtet, in Fußplatte anschlussfertig verdrahtet, Leuchten-Gesamthöhe 1400 mm</p> <p>Mit hochwertiger Porzellanfassung E27, für Glühlampen bis max. 100 Watt</p>	<p>Reflektor-Ø / Reflektorhöhe 250 mm / 180 mm 300 mm / 240 mm 350 mm / 255 mm 400 mm / 270 mm</p> <p>Leuchten-Gesamthöhe 1400 mm 1800 mm 1600 mm 2000 mm</p> <p>Haupttypen</p> <p>Sonderausführungen auf Anfrage</p>	<p>Standrohr ausschließlich in Stahl, mit massiver Fußplatte Ø 150 mm verschweißt</p> 	 <p>E27 E27</p>  <p>CE 230 V 50 Hz</p> <p>IP 20 Außenbereich</p>  <p>elektrische Bauteile geprüft</p>
--	---	--	--

Materialien - Oberflächen des Reflektors

Aluminium beschichtet / lackiert



Tiefschwarz
A/S



Reinweiß, RAL 9010
A/W

Sonderlackierung in RAL-Farbtönen möglich

Aluminium natur



ohne Lackierung
A/R



Klarlack matt
A/M



Klarlack glänzend
A/G

Kupfer natur



ohne Lackierung
K/R



Klarlack matt
K/M



Klarlack glänzend
K/G

Materialien - Oberflächen des Standrohrs

Stahlrohr beschichtet / lackiert



Tiefschwarz
S/S



Reinweiß, RAL 9010
S/W

Sonderlackierung in RAL-Farbtönen möglich

Eine klassisch-elegante Leuchte mit gewölbtem Schirm und opalem Schraubglas in Kugelform als Standleuchte.

Aus traditionell gefertigten Guss- und Drückteilen mit geschwungenem Bogenarm.

Besonders in der tiefschwarzen Variante besticht sie mit ihren harmonischen Rundungen als ideale Park-, Garten- und Hofleuchte.



Retz Kugel Stand

<p>Abgebildete Leuchte: Reflektor-Ø 260 mm, aus hochwertigem rostfreiem Aluminium, außen Tiefschwarz (A/S), innen Reinweiß, opales Kugelglas bis 60 Watt, Standrohr aus Stahlrohr und Fußplatte aus Massiv-Eisen, spezialgrundiert und Tiefschwarz (S/S) beschichtet, in Fußplatte anschlussfertig verdrahtet, Leuchten-Gesamthöhe 1400 mm</p> <p>Mit hochwertiger Porzellanfassung E27, für Glühlampen bis max. 60/100 Watt</p>	<p>Reflektor-Ø 260 mm</p> <p>Glas-Ø / Reflektorhöhe mit Glas 160 mm / 200 mm (max. 60 Watt) 180 mm / 230 mm (max. 100 Watt)</p> <p>Leuchten-Gesamthöhe ■ 1400 mm ■ 1800 mm ■ 1600 mm ■ 2000 mm ■ Haupttypen</p> <p>Sonderausführungen auf Anfrage</p>	<p>Standrohr ausschließlich in Stahl, mit massiver Fußplatte Ø 150 mm verschweißt</p> 	 E27  E27
		 230 V 50 Hz	 IP 54 Außenbereich
		  elektrische Bauteile geprüft	

Materialien - Oberflächen des Reflektors

Aluminium beschichtet / lackiert



Tiefschwarz
A/S



Reinweiß, RAL 9010
A/W

Sonderlackierung in RAL-Farbtönen möglich

Aluminium natur



ohne Lackierung
A/R



Klarlack matt
A/M



Klarlack glänzend
A/G

Kupfer natur



ohne Lackierung
K/R



Klarlack matt
K/M



Klarlack glänzend
K/G

Materialien - Oberflächen des Standrohrs

Stahlrohr beschichtet / lackiert



Tiefschwarz
S/S



Reinweiß, RAL 9010
S/W

Sonderlackierung in RAL-Farbtönen möglich

Eine schlichte Leuchte mit gewölbtem Schirm und Schraubglas in Zylinderform als Standleuchte. Aus traditionell gefertigten Guss- und Drückteilen mit geschwungenem Bogenarm. Besonders in der tiefschwarzen Variante besticht sie durch ihre Klarheit in Form und Farbe und fügt sich harmonisch in ältere sowie neue Hof- und Gartenanlagen ein.



Retz Zylinder Stand

<p>Abgebildete Leuchte: Reflektor-Ø 260 mm, aus hochwertigem rostfreiem Aluminium, außen Tiefschwarz (A/S), innen Reinweiß, klares Zylinderglas bis 60 Watt, Standrohr aus Stahlrohr und Fußplatte aus Massiv-Eisen, spezialgrundiert und Tiefschwarz (S/S) beschichtet, in Fußplatte anschlussfertig verdrahtet, Leuchten-Gesamthöhe 1400 mm</p> <p>Mit hochwertiger Porzellanfassung E27, für Glühlampen bis max. 60/100 Watt</p>	<p>Reflektor-Ø 260 mm</p> <p>Glas-Ø / Reflektorhöhe mit Glas 100 mm / 200 mm (max. 60 Watt) 110 mm / 230 mm (max. 100 Watt)</p> <p>Leuchten-Gesamthöhe ■ 1400 mm ■ 1800 mm ■ 1600 mm ■ 2000 mm</p> <p>■ Haupttypen</p> <p>Extras • Zylinderglas auch in Matt lieferbar</p> <p>Sonderausführungen auf Anfrage</p>	<p>Standrohr ausschließlich in Stahl, mit massiver Fußplatte Ø 150 mm verschweißt</p> 	 E27  E27  230 V 50 Hz  IP 54  Außenbereich    elektrische Bauteile geprüft
--	--	--	---

Materialien - Oberflächen des Reflektors

Aluminium beschichtet / lackiert



Tiefschwarz
A/S



Reinweiß, RAL 9010
A/W

Sonderlackierung in RAL-Farbtönen möglich

Aluminium natur



ohne Lackierung
A/R



Klarlack matt
A/M



Klarlack glänzend
A/G

Kupfer natur



ohne Lackierung
K/R



Klarlack matt
K/M



Klarlack glänzend
K/G

Materialien - Oberflächen des Standrohrs

Stahlrohr beschichtet / lackiert



Tiefschwarz
S/S



Reinweiß, RAL 9010
S/W

Sonderlackierung in RAL-Farbtönen möglich

Eine schlichte Doppel-Leuchte mit zwei gewölbten Schirmen und Schraubgläsern in Zylinderform als Standleuchte. Aus traditionell gefertigten Guss- und Drückteilen mit geschwungenen Bogenarmen. Besonders in der tiefschwarzen Variante besteht sie durch ihre Klarheit in Form und Farbe und fügt sich harmonisch in ältere sowie neue Hof- und Gartenanlagen ein.



Retz Zylinder II Stand

<p>Abgebildete Leuchte: Reflektoren-Ø 260 mm, aus hochwertigem rostfreiem Aluminium, außen Tiefschwarz (A/S), innen Reinweiß, klare Zylindergläser bis 100 Watt. Standrohr aus Stahlrohr und Fußplatte aus Massiv-Eisen, spezialgrundiert und Tiefschwarz (S/S) beschichtet, in Fußplatte anschlussfertig verdrahtet, Leuchten-Gesamthöhe 1400 mm</p> <p>Mit hochwertiger Porzellanfassung E27, für Glühlampen bis max. 60/100 Watt</p>	<p>Reflektor-Ø 260 mm</p> <p>Glas-Ø / Reflektorhöhe mit Glas 100 mm / 200 mm (max. 60 Watt) 110 mm / 230 mm (max. 100 Watt)</p> <p>Leuchten-Gesamthöhe ■ 1400 mm ■ 1800 mm ■ 1600 mm ■ 2000 mm ■ Haupttypen</p> <p>Extras • Zylinderglas auch in Matt lieferbar</p> <p>Sonderausführungen auf Anfrage</p>	<p>Standrohr ausschließlich in Stahl, mit massiver Fußplatte Ø 150 mm verschweißt</p> 	 E27  E27
		 230 V 50 Hz	 IP 54 Außenbereich
		 elektrische Bauteile geprüft	

Materialien - Oberflächen des Reflektors

Aluminium beschichtet / lackiert



Tiefschwarz
A/S



Reinweiß, RAL 9010
A/W

Sonderlackierung in RAL-Farbtönen möglich

Aluminium natur



ohne Lackierung
A/R



Klarlack matt
A/M



Klarlack glänzend
A/G

Kupfer natur



ohne Lackierung
K/R



Klarlack matt
K/M



Klarlack glänzend
K/G

Materialien - Oberflächen des Standrohrs

Stahlrohr beschichtet / lackiert



Tiefschwarz
S/S



Reinweiß, RAL 9010
S/W

Sonderlackierung in RAL-Farbtönen möglich

Eine elegante Leuchte mit rundlichem Schirm und opalem Schraubglas in Kugelform als Standleuchte. Aus traditionell gefertigten Guss- und Drückteilen sowie einzelnen Porzellanelementen. Das Spiel der Rundungen von Schirm und Kugelglas verleiht der Leuchte ihr unverkennbares Äußeres.



Wels Kugel Stand

<p>Abgebildete Leuchte: Reflektor-Ø 350 mm, aus hochwertigem rostfreiem Aluminium, außen Tiefschwarz (A/S), innen Reinweiß, opales Kugelglas bis 100 Watt, Standrohr aus Stahlrohr und Fußplatte aus Massiv-Eisen, spezialgrundiert und Tiefschwarz (S/S) beschichtet, in Fußplatte anschlussfertig verdrahtet, Leuchten-Gesamthöhe 1400 mm</p> <p>Mit hochwertiger Porzellanfassung E27, für Glühlampen bis max. 100 Watt</p>	<p>Reflektor-Ø 350 mm</p> <p>Glas-Ø / Reflektorhöhe mit Glas 180 mm / 280 mm</p> <p>Leuchten-Gesamthöhe ■ 1400 m ■ 1800 m ■ 1600 m ■ 2000 m ■ Haupttypen</p> <p>Sonderausführungen auf Anfrage</p>	<p>Standrohr ausschließlich in Stahl, mit massiver Fußplatte Ø 150 mm verschweißt</p> 	<div style="display: flex; justify-content: space-around;"> <div style="text-align: center;">  E27 </div> <div style="text-align: center;">  E27 </div> </div> <div style="display: flex; justify-content: space-around; margin-top: 10px;"> <div style="border: 1px solid black; padding: 2px;"> CE </div> <div style="border: 1px solid black; padding: 2px;"> 230 V 50 Hz </div> </div> <div style="display: flex; justify-content: space-around; margin-top: 10px;"> <div style="border: 1px solid black; padding: 2px;">  </div> <div style="border: 1px solid black; padding: 2px;"> IP 54 </div> <div style="border: 1px solid black; padding: 2px;"> Außenbereich </div> </div> <div style="display: flex; justify-content: space-around; margin-top: 10px;">   elektrische Bauteile geprüft </div>
---	--	--	---

Materialien - Oberflächen des Reflektors

Aluminium beschichtet / lackiert



Tiefschwarz
A/S



Reinweiß, RAL 9010
A/W

Sonderlackierung in RAL-Farbtönen möglich

Aluminium natur



ohne Lackierung
A/R



Klarlack matt
A/M



Klarlack glänzend
A/G

Kupfer natur



ohne Lackierung
K/R



Klarlack matt
K/M



Klarlack glänzend
K/G

Materialien - Oberflächen des Standrohrs

Stahlrohr beschichtet / lackiert



Tiefschwarz
S/S



Reinweiß, RAL 9010
S/W

Sonderlackierung in RAL-Farbtönen möglich

Eine elegante Leuchte mit flachem Schirm und opalem Schraubglas in Kugelform als Standleuchte. Aus traditionell gefertigten Guss- und Drückteilen mit geschwungenem Bogenarm. Die eigenwillige Schichtung der in der Drück- und Sicken-technik gearbeiteten Kubatur verleiht ihr ein besonders extravagantes Äußeres. Im Garten, Hof und auf Wegen verbreitet die Leuchte ein angenehm homogenes Licht.



Salzburg Kugel Stand

<p>Abgebildete Leuchte: Reflektor-Ø 350 mm, aus hochwertigem rostfreiem Aluminium, außen Tiefschwarz (A/S), innen Reinweiß, opales Kugelglas bis 100 Watt, Standrohr aus Stahlrohr und Fußplatte aus Massiv-Eisen, spezialgrundiert und Tiefschwarz (S/S) beschichtet, in Fußplatte anschlussfertig verdrahtet, Leuchten-Gesamthöhe 1400 mm</p> <p>Mit hochwertiger Porzellanfassung E27, für Glühlampen bis max. 100 Watt</p>	<p>Reflektor-Ø ■ 300 mm 400 mm ■ 350 mm</p> <p>Glas-Ø / Reflektorhöhe mit Glas 180 mm / 320 mm</p> <p>Leuchten-Gesamthöhe ■ 1400 mm ■ 1800 mm ■ 1600 mm 2000 mm ■ Haupttypen</p> <p>Sonderausführungen auf Anfrage</p>	<p>Standrohr ausschließlich in Stahl, mit massiver Fußplatte Ø 150 mm verschweißt</p> 	 E27  E27  230 V 50 Hz  IP 54  Außenbereich   elektrische Bauteile geprüft
---	---	--	---

Materialien - Oberflächen des Reflektors

Aluminium beschichtet / lackiert



Tiefschwarz
A/S



Reinweiß, RAL 9010
A/W

Sonderlackierung in RAL-Farbtönen möglich

Aluminium natur



ohne Lackierung
A/R



Klarlack matt
A/M



Klarlack glänzend
A/G

Kupfer natur



ohne Lackierung
K/R



Klarlack matt
K/M



Klarlack glänzend
K/G

Materialien - Oberflächen des Standrohrs

Stahlrohr beschichtet / lackiert



Tiefschwarz
S/S



Reinweiß, RAL 9010
S/W

Sonderlackierung in RAL-Farbtönen möglich



Tischleuchten

Die für ihre Zeit typische Tischleuchte legt als reduzierte Funktionsleuchte ihren Schwerpunkt auf einfache Formen und Fügungen. Aus traditionell gefertigten Guss- und Drückteilen sowie einzelnen Porzellanelementen. Auch wenn es nichts gibt, was nicht einer eindeutigen Funktion folgt, besticht diese Tischleuchte gerade durch die Klarheit ihrer Form und Fertigung.



Penzing Tisch

<p>Abgebildete Leuchte: Reflektor-Ø 150 mm, aus veredeltem Stahlblech, außen Tiefschwarz (S/S), innen Reinweiß, Gelenkteile und Schalter vernickelt, stahlblechverkleideter Gusseisenfuß mit Schalter, schwarzes Textil-Kabel (TS) 1,5 m lang, Schukostecker</p> <p>Mit hochwertiger Fassung E27, für Glühlampen bis max. 100 Watt</p>	<p>Leuchtenhöhe 500 mm</p> <p>Reflektor-Ø 150 mm</p> <p>Reflektorhöhe 150 mm</p> <p>Fuß-Ø 180 mm</p> <p>Sonderausführungen auf Anfrage</p>		E27 E27 IP 20 elektrische Bauteile geprüft
---	--	--	---

Materialien - Oberflächen

Stahlblech beschichtet / lackiert



Tiefschwarz
S/S



Reinweiß, RAL 9010
S/W

Sonderlackierung in RAL-Farbtönen möglich

Stahlblech natur



Klarlack matt
S/M



Klarlack glänzend
S/G

Kabelvarianten



PVC-Kabel
schwarz.../PS



PVC-Kabel
weiß.../PW



Textil-Kabel
schwarz.../TS



Textil-Kabel
weiß.../TW

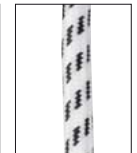

Textil-Kabel
schwarz-weiß.../TSW

Die für ihre Zeit typische Tischleuchte legt als reduzierte Funktionsleuchte mit Klemmarm ihren Schwerpunkt auf einfache Formen und Fügungen. Aus traditionell gefertigten Guss- und Drückteilen sowie einzelnen Porzellanelementen. Auch wenn es nichts gibt, was nicht einer eindeutigen Funktion folgt, besticht diese Tischleuchte gerade durch die Klarheit ihrer Form und Fertigung.



Penzing Klemm Tisch

<p>Abgebildete Leuchte: Reflektor-Ø 150 mm, aus veredeltem Stahlblech, außen Tiefschwarz (S/S), innen Reinweiß, Gelenkteile vernickelt, Klemme gedrückt aus Messingblech, schwarzes Textil-Kabel (TS) 1,5 m lang, Schuko-stecker</p> <p>Mit hochwertiger Fassung E27, für Glühlampen bis max. 100 Watt</p>	<p>Leuchtenhöhe 500 mm</p> <p>Reflektor-Ø 150 mm</p> <p>Reflektorhöhe 150 mm</p> <p>Sonderausführungen auf Anfrage</p>	 <p>Klemmbacken mit Schutzgummis Klemmbereich bis 35 mm</p>	 <p>E27 E27</p>  <p>CE 230 V 50 Hz</p> <p>IP 20</p>  <p>VDE elektrische Bauteile geprüft</p>
---	---	---	--

Materialien - Oberflächen

Stahlblech beschichtet / lackiert



Tiefschwarz
S/S



Reinweiß, RAL 9010
S/W

Sonderlackierung in RAL-Farbtönen möglich

Stahlblech natur



Klarlack matt
S/M



Klarlack glänzend
S/G

Kabelvarianten



PVC-Kabel
schwarz.../PS



PVC-Kabel
weiß.../PW



Textil-Kabel
schwarz.../TS



Textil-Kabel
weiß.../TW



Textil-Kabel
schwarz-weiß.../TSW

Die Tischleuchte mit ihrem dezenten Einsatz vernickelter Teile verströmt noch heute das Flair gründerzeitlicher Schreibtische.

Aus traditionell gefertigten Guss- und Drückteilen sowie einzelnen Porzellanelementen. Die schlichten, aber hochwertigen Beschläge, die kalkulierten Materialwechsel oder auch der asymmetrisch vorstehende Reflektor gehören zu den subtilen Details, die aus dem spröden Klassiker ein selten erreichtes Original machen.



Hietzing Tisch

<p>Abgebildete Leuchte: Reflektor-Ø 235 mm, aus veredeltem Stahlblech, außen Tiefschwarz (S/S), innen Reinweiß, Gelenkteile und Schalter vernickelt, stahlblechverkleideter Gusseisenfuß mit Schalter, schwarz-weißes Textil-Kabel (TSW) 1,5 m lang, Schuko-stecker</p> <p>Mit hochwertiger Fassung E27, für Glühlampen bis max. 100 Watt</p>	<p>Leuchtenhöhe 680 mm</p> <p>Reflektor-Ø 235 mm</p> <p>Reflektorhöhe 200 mm</p> <p>Fuß-Ø 220 mm</p> <p>Sonderausführungen auf Anfrage</p>	<p>Durch zwei hochwertige Gelenke nach allen Seiten dreh- und schwenkbar</p> 	 E27  E27  230 V 50 Hz  IP 20   elektrische Bauteile geprüft
--	--	---	---

Materialien - Oberflächen

Stahlblech beschichtet / lackiert



Tiefschwarz
S/S



Reinweiß, RAL 9010
S/W

Sonderlackierung in RAL-Farbtönen möglich

Stahlblech natur



Klarlack matt
S/M



Klarlack glänzend
S/G

Kabelvarianten



PVC-Kabel
schwarz.../PS



PVC-Kabel
weiß.../PW



Textil-Kabel
schwarz.../TS

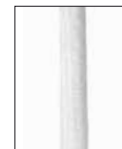

Textil-Kabel
weiß.../TW

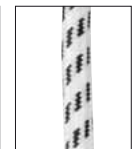

Textil-Kabel
schwarz-weiß.../TSW

Die Tischleuchte mit geschwungenem Schwenkarm und becherförmigem Reflektor gehört zu den Klassikern auf Schreib- oder Nachttisch. Aus traditionell gefertigten Guss- und Drückteilen. Der kombinierte Materialeinsatz von vernickeltem und tiefschwarz pulverbeschichtetem Stahl verleiht der Leuchte mit ihrer schlichten Formensprache klassische Eleganz.



Döbling Tisch

<p>Abgebildete Leuchte: Reflektor-Ø 140 mm, aus veredeltem Stahlblech, außen Tiefschwarz (S/S), innen Reinweiß, Schwenkarm und Gelenke vernickelt, stahlblechverkleideter Gusseisenfuß, schwarzes Textil-Kabel (TS) 1,5 m lang mit Schalter, Schuko-Stecker</p> <p>Mit hochwertiger Fassung E14, für Glühlampen bis max. 60 Watt</p>	<p>Leuchtenhöhe 500 mm</p> <p>Reflektor-Ø 140 mm</p> <p>Reflektorhöhe 160 mm</p> <p>Fuß-Ø 180 mm</p> <p>Sonderausführungen auf Anfrage</p>	 <p>Durch hochwertige Gelenke nach allen Seiten dreh- und schwenkbar</p>	<div style="display: flex; justify-content: space-around;"> <div style="text-align: center;">  E14 </div> <div style="text-align: center;">  E14 </div> </div> <div style="display: flex; justify-content: space-around; margin-top: 10px;"> <div style="text-align: center;">  CE </div> <div style="text-align: center;"> 230 V 50 Hz </div> </div> <div style="display: flex; justify-content: space-around; margin-top: 10px;"> <div style="text-align: center;">  IP 20 </div> <div style="text-align: center;">  <small>elektrische Bauteile geprüft</small> </div> </div>
---	--	--	---

Materialien - Oberflächen

Stahlblech beschichtet / lackiert

 Tiefschwarz
S/S

 Reinweiß, RAL 9010
S/W

Sonderlackierung in RAL-Farbtönen möglich

Stahlblech natur

 Klarlack matt
S/M

 Klarlack glänzend
S/G

Kabelvarianten



PVC-Kabel
schwarz.../PS



PVC-Kabel
weiß.../PW



Textil-Kabel
schwarz.../TS



Textil-Kabel
weiß.../TW







Textil-Kabel
schwarz-weiß.../TSW

Die Tischleuchte mit Triangel-Schwenkarm und Reflektor in zylindrischer Form spricht die besonders reizvolle Sprache eines in den Anfängen begriffenen technischen Zeitalters.

Aus traditionell gefertigten Guss- und Drückteilen sowie einzelnen Messingelementen. Der massive, langgezogene Reflektor, gehalten durch einen filigranen Schwenkarm, ist eine extravagante Ergänzung für den klassischen Studierplatz in Bibliothek oder Arbeitszimmer.



Wien Tisch

<p>Abgebildete Leuchte: Reflektor-Ø 75 mm, -länge 345 mm, aus veredeltem Stahlblech, außen Tiefschwarz (S/S), innen hochglanzeloxierter Spiegel, Griff und Abschlusselemente Massiv-Messing, Triangel-Schwenkarm aus Stahlrohr Ø 16 mm, stahlblechverkleideter Gusseisenfuß mit Schalter, schwarzes Textil-Kabel (TS) 1,5 m lang, Schukostecker</p> <p>Mit hochwertigen Fassungen E14, für 2 Glühlampen bis je max. 60 Watt</p>	<p>Leuchtenhöhe / Leuchtenbreite 500 mm / 470 mm</p> <p>Fußlänge / -breite / -höhe 250 mm / 165 mm / 30 mm</p> <p>Extras • Abschlusselemente wahlweise in Messing oder Nickel bestellbar</p> <p>Sonderausführungen auf Anfrage</p>	 <p>Nach allen Seiten dreh- und schwenkbar</p>	<div style="display: flex; justify-content: space-around;"> <div style="text-align: center;">  E14 </div> <div style="text-align: center;">  E14 </div> </div> <div style="display: flex; justify-content: space-around; margin-top: 10px;"> <div style="text-align: center;">  230 V 50 Hz </div> <div style="text-align: center;">  IP 20 </div> </div> <div style="text-align: right; margin-top: 10px;">  elektrische Bauteile geprüft </div>
--	---	--	--

Materialien - Oberflächen

Stahlblech beschichtet / lackiert

 Tiefschwarz
S/S

 Reinweiß, RAL 9010
S/W

Sonderlackierung in RAL-Farbtönen möglich

Stahlblech natur

 Klarlack matt
S/M

 Klarlack glänzend
S/G

Kabelvarianten



PVC-Kabel
schwarz.../PS



PVC-Kabel
weiß.../PW



Textil-Kabel
schwarz.../TS



Textil-Kabel
weiß.../TW



Textil-Kabel
schwarz-weiß.../TSW



Strahler



Ein rundes Anleuchtgerät als Strahler mit halbrundem Reflektor und massiven Trägerbügeln. Aus traditionell gefertigten Druckteilen sowie einzelnen Gusselementen und gewölbtem Echtglas aus einer Traditions-Glashütte. Auch nach der Montage dreh- und schwenkbar in alle Richtungen, überzeugt der Strahler durch die Eleganz seiner funktionalen Form.

Innsbruck

<p>Abgebildete Leuchte: Reflektor-Ø 420 mm und Trägerbügel aus veredeltem Stahlblech, außen Tiefschwarz (S/S), innen Reinweiß, klares gewölbtes Glas, schwarz-weißes Textil-Kabel (TSW) 1,5 m lang, Schukostecker</p> <p>Mit hochwertiger Porzellanfassung E27, für Glühlampen bis max. 100 Watt</p>	<p>Reflektor-Ø / Leuchtenhöhe / Glas-Ø</p> <table border="0"> <tr> <td>270 mm</td> <td>/ 500 mm</td> <td>/ 250 mm</td> </tr> <tr> <td>320 mm</td> <td>/ 580 mm</td> <td>/ 300 mm</td> </tr> <tr> <td>370 mm</td> <td>/ 660 mm</td> <td>/ 350 mm</td> </tr> <tr> <td>420 mm</td> <td>/ 740 mm</td> <td>/ 400 mm</td> </tr> </table> <p>Extras</p> <ul style="list-style-type: none"> • Fassung E40 für Glühlampen bei Ø 370 mm bis 500 Watt bei Ø 420 mm bis 1000 Watt Lieferung ohne Anschlusskabel • Auch für den Außenbereich bestellbar <p>Sonderausführungen auf Anfrage</p>	270 mm	/ 500 mm	/ 250 mm	320 mm	/ 580 mm	/ 300 mm	370 mm	/ 660 mm	/ 350 mm	420 mm	/ 740 mm	/ 400 mm	 <p>Die Leuchte ist auch an der Wand montierbar</p>	<table border="1"> <tr> <td> E27</td> <td> E27</td> </tr> <tr> <td> E40</td> <td></td> </tr> <tr> <td> 230 V 50 Hz</td> <td> IP 20</td> </tr> <tr> <td></td> <td>Außenbereich</td> </tr> <tr> <td colspan="2">  elektrische Bauteile geprüft</td> </tr> </table>	 E27	 E27	 E40		 230 V 50 Hz	 IP 20		Außenbereich	  elektrische Bauteile geprüft	
270 mm	/ 500 mm	/ 250 mm																							
320 mm	/ 580 mm	/ 300 mm																							
370 mm	/ 660 mm	/ 350 mm																							
420 mm	/ 740 mm	/ 400 mm																							
 E27	 E27																								
 E40																									
 230 V 50 Hz	 IP 20																								
	Außenbereich																								
  elektrische Bauteile geprüft																									

Materialien - Oberflächen

Stahlblech beschichtet / lackiert

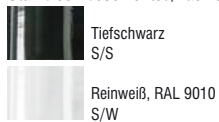

Sonderlackierung in RAL-Farbtönen möglich

Aluminium natur

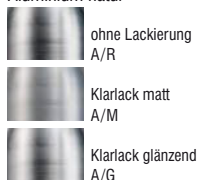

Stahlblech natur



Kabelvarianten

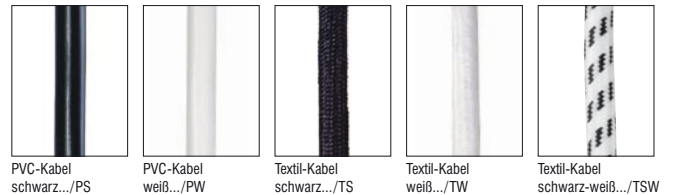



Ein kantiger Scheinwerfer als Strahler mit zylindrischem Reflektor und massiven Trägerbügeln. Aus traditionell gefertigten Druckteilen sowie einzelnen Guss-elementen und gewölbtem Echtglas aus einer Traditions-Glashütte. Mit eingesetztem Spiegel-Reflektor aus hochglanzeloxiertem Aluminium zur Erhöhung der Lichtstärke. Auch nach der Montage dreh- und schwenkbar in alle Richtungen, überzeugt der Strahler durch die Klarheit seiner funktionalen Form.

Landeck

<p>Abgebildete Leuchte: Reflektor-Ø 370 mm und Trägerbügel aus veredeltem Stahlblech, außen Tiefschwarz (S/S), innen Reinweiß, klares gewölbtes Glas, schwarz-weißes Textil-Kabel (TSW) 1,5 m lang, Schuko-stecker</p> <p>Mit hochwertiger Porzellanfassung E27, für Glühlampen bis max. 100 Watt</p>	<p>Reflektor-Ø / Leuchtenhöhe / Glas-Ø 370 mm / 690 mm / 350 mm 420 mm / 770 mm / 400 mm</p> <p>Extras</p> <ul style="list-style-type: none"> • Fassung E40 für Glühlampen bei Ø 370 mm bis 500 Watt bei Ø 420 mm bis 1000 Watt • Lieferung ohne Anschlusskabel • Auch für den Außenbereich bestellbar <p>Sonderausführungen auf Anfrage</p>	<p>Die Leuchte ist auch an der Wand montierbar</p>	<table border="1"> <tr> <td> E27</td> <td> E27</td> </tr> <tr> <td> E40</td> <td> E40</td> </tr> <tr> <td> 230 V 50 Hz</td> <td> IP 20</td> </tr> <tr> <td></td> <td> Außenbereich</td> </tr> <tr> <td colspan="2"> elektrische Bauteile geprüft</td> </tr> </table>	 E27	 E27	 E40	 E40	 230 V 50 Hz	 IP 20		 Außenbereich	elektrische Bauteile geprüft	
 E27	 E27												
 E40	 E40												
 230 V 50 Hz	 IP 20												
	 Außenbereich												
elektrische Bauteile geprüft													

Materialien - Oberflächen

Stahlblech beschichtet / lackiert

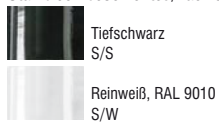

Sonderlackierung in RAL-Farbtönen möglich

Aluminium natur

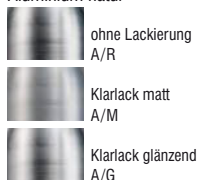

Stahlblech natur



Kabelvarianten

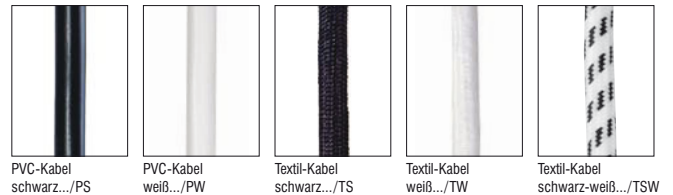



Sonderlösungen



Sonderedition Hängeleuchte
aus Anlass der Fußball-WM 2014



Fan-Edition

Limitierte Auflage:

Sievering, Reflektor-O/ 400 mm
Stahlbech, außen Schwarz matt RAL 9005, innen Perlgold RAL 1036,
rotes Textil-Kabel (K/TR)

Während der WM 2014 sind alle Leuchten in den gewünschten Nationalfarben (RAL-Farben) erhältlich.



NEU:

Textil-Kabel in rot (K/TR)
mit Metall-Baldachin Halbkugel Ø80 mm

Rotes Textil-Kabel (K/TR) ist ab sofort für alle Leuchten erhältlich.



Ausführung:

Fälschungssichere Schlagzahlen-Nummerierung von 1 bis 2014



E

Sievering

Bestellbeispiel:

Reflektor-O/ 400 mm
 Stahlblech roh (S/R), dem natürlichen Altern überlassen
 Alu-Gussaufhängung mit Kette roh/schwarzes PVC-Kabel (AGK/PS)

Die Leuchte in Stahlblech, roh ist mit der unlackierten Oberfläche dem natürlichen Altern überlassen. Nach einiger Zeit entwickelt sich eine individuelle Rostpatina.

Alle Bestellvarianten finden Sie auf dem ausführlichen Produktblatt



E

Schwechat

Bestellbeispiel:

Reflektor-O/ 350 mm
 Stahlblech roh (S/R), dem natürlichen Altern überlassen
 Alu-Gussaufhängung mit Kette roh/schwarzes PVC-Kabel (AGK/PS)

Die Leuchte in Stahlblech, roh ist mit der unlackierten Oberfläche dem natürlichen Altern überlassen. Nach einiger Zeit entwickelt sich eine individuelle Rostpatina.

Alle Bestellvarianten finden Sie auf dem ausführlichen Produktblatt



Bregenz Wand

Bestellbeispiel:

Reflektorgroße 350 mm x 290 mm (Typ 307) Stahlblech roh (S/R), dem natürlichen Altern überlassen
 Stahl-Wandarm
 Doppelrohr senkrecht (W340)
 Alu-Gussrosette in Langform 175 x 55 mm

Die Leuchte in Stahlblech, roh ist mit der unlackierten Oberfläche dem natürlichen Altern überlassen. Nach einiger Zeit entwickelt sich eine individuelle Rostpatina.

Alle Bestellvarianten finden Sie auf dem ausführlichen Produktblatt



E

Sonderanfertigung auf Basis **Sievering**

Bestellbeispiel:

Reflektor-O/ 400 mm
 Stahlblech beschichtet/außen Tiefschwarz (S/S), innen Reinweiß
 Rohrausleger je 400 mm Ø 16 mm, Zahngelenke Messing vernickelt (Z/MN)
 Alu-Gussrosette Ø 100 mm

Alle Bestellvarianten finden Sie auf dem ausführlichen Produktblatt



E

Sonderanfertigung auf Basis **Sievering**

Bestellbeispiel:

Reflektor-O/ 400 mm
 Stahlblech beschichtet/außen Tiefschwarz (S/S), innen Reinweiß
 Einflammiger-Rohrausleger 150 mm schräg, 500 mm senkrecht Ø 16 mm
 mit Metall-Baldachin in Würfelform, 100 x 100 x 60 mm



E

Sonderanfertigung auf Basis **Sievering**

Bestellbeispiel:

Reflektor-O/ 400 mm
 Stahlblech beschichtet/außen Tiefschwarz (S/S), innen Reinweiß,
 Zweiflammiger-Rohrausleger je 150 mm schräg, je 300 mm waagrecht,
 je 500 mm senkrecht Ø 16 mm, Zahngelenke Messing vernickelt (Z/MN)
 mit Metall-Baldachin in Würfelform, 100 x 100 x 60 mm



E

Sonderanfertigung auf Basis **Sievering**

Bestellbeispiel:

Reflektor-O/ 400 mm
 Stahlblech beschichtet/außen Tiefschwarz (S/S), innen Reinweiß,
 Vierflammiger-Rohrausleger je 150 mm schräg, je 300 mm waagrecht,
 je 500 mm senkrecht Ø 16 mm, Zahngelenke Messing vernickelt (Z/MN)
 mit Metall-Baldachin in Würfelform, 100 x 100 x 60 mm



Sonderanfertigung auf Basis **Sievering**

Bestellbeispiel:

verkürzter Reflektor-O/ 400 mm Stahlblech beschichtet/außen Tiefschwarz (S/S), innen Reinweiß
Alu-Gussaufhängung mit vernickelter Kette/schwarzes Textil-Kabel (AGK/TS)

Abbildung mit Philips Softone 16 Watt ESaver



Sonderanfertigung auf Basis **Sievering**

Bestellbeispiel:

verkürzter Reflektor-O/ 300 mm Stahlblech beschichtet/außen Tiefschwarz (S/S), innen Reinweiß Kabel-Aufhängung/schwarz-weißes Textil-Kabel (K/TSW)

Abbildung mit Osram CIRCULUX EL 24/827, Sockel E27



Sonderanfertigung auf Basis **Sievering**

Bestellbeispiel:

Reflektor-O/ 450 mm
Stahlblech beschichtet/außen Tiefschwarz (S/S), innen Reinweiß
mit Massivausleger Stahl-Doppelrohr, Ausladung 1000 mm,
Leuchten-Gesamthöhe 800 mm, Hauptrohre Ø45 mm,
Verbindungsrohre Ø16 mm, mit Flanschanschluss für kundenseitigen
Mast Ø60 mm



Sonderanfertigung auf Basis **Sievering Wand**

Bestellbeispiel:

Reflektor-O/ 400 mm Stahlblech beschichtet/außen Tiefschwarz (S/S), innen Reinweiß Alu-Wandarm Doppelrohr, 2 x 500 mm
vorne senkrecht O/ 16 mm, Zahnelenke Messing vernickelt (Z/ MN)
Alu-Gussrosette in Langform 175 x 55 mm

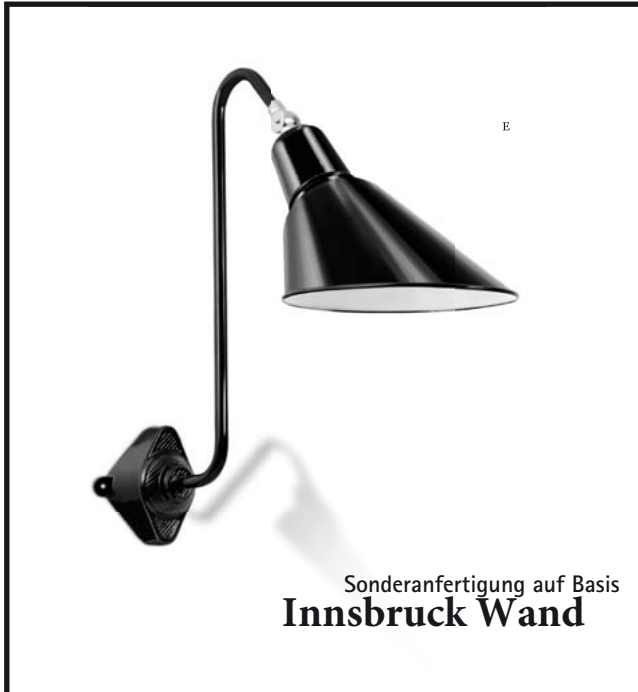

Sonderanfertigung auf Basis
Innsbruck Wand

Bestellbeispiel:

Reflektorgröße 280 mm x 230 mm (Typ 306)
Aluminium beschichtet/außen Tiefschwarz (A/S), innen Reinweiß Alu-
Wandarm Einrohr geschwungen 200 mm,
mit verlängertem Verbindungsrohr 600 mm,
Zahngelenk Messing vernickelt (Z/MN), Alu-Eckrosette 145 x 115 mm

Alle Bestellvarianten finden Sie auf dem ausführlichen Produktblatt

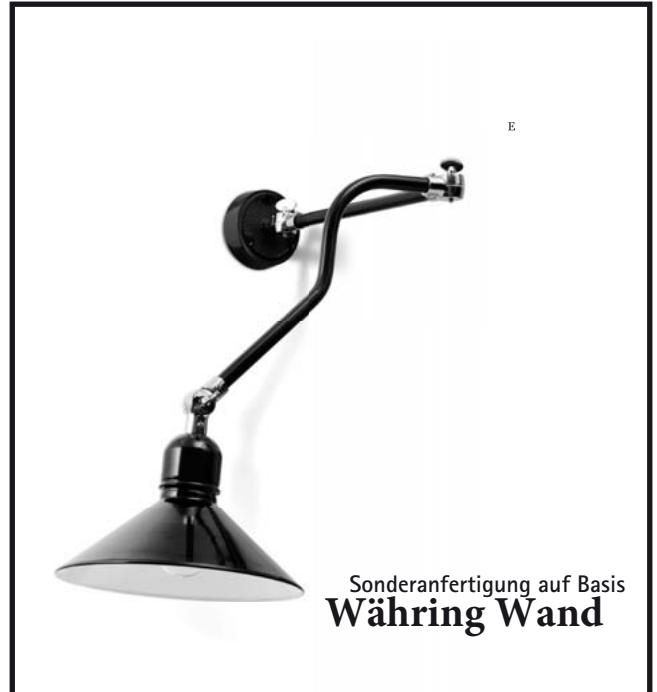

Sonderanfertigung auf Basis
Währing Wand

Bestellbeispiel:

Reflektor-O/ 240 mm Stahlblech beschichtet/außen Tiefschwarz
(S/S), innen Reinweiß Rohausleger gesamt 600 mm (250 mm
+ 350 mm) O/ 16 mm Zahngelenke Messing vernickelt (Z/MN)
Alu-Gussrosette O/ 100 mm

Alle Bestellvarianten finden Sie auf dem ausführlichen Produktblatt



Sonderanfertigung auf Basis
Spittelberg Wand

Bestellbeispiel:

Wand, Reflektor-O/ 350 mm Stahlblech beschichtet/außen
Tiefschwarz (S/S), innen Reinweiß Rohausleger gesamt 500 mm
(150 mm + 350 mm) O/ 16 mm, Zahngelenke Messing vernickelt (Z/
MN), Alu-Eckrosette 145 x 115 mm

Alle Bestellvarianten finden Sie auf dem ausführlichen Produktblatt

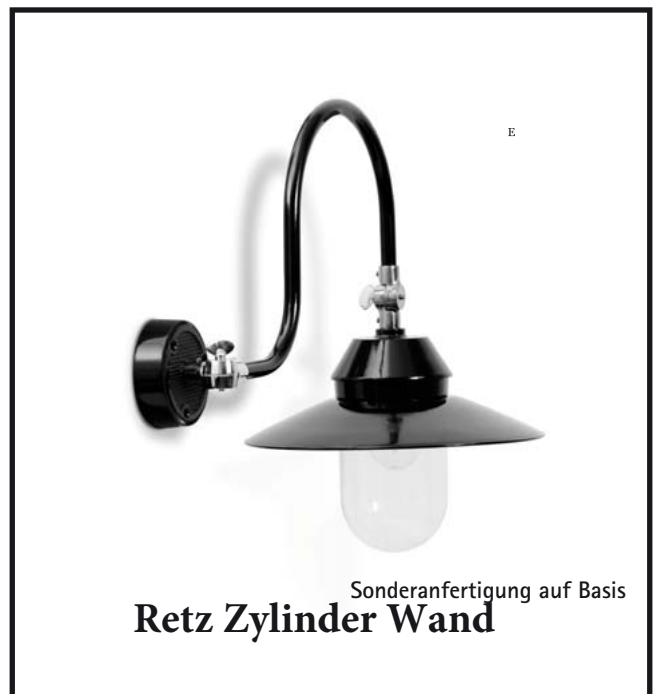

Sonderanfertigung auf Basis
Retz Zylinder Wand

Bestellbeispiel:

Reflektor-O/ 300 mm Aluminium beschichtet/außen Tiefschwarz (A/S),
innen Reinweiß Zylinderglas klar (max. 100 Watt)
Alu-Wandarm Einrohr geschwungen 370 mm (W1600)
Zahngelenke Messing vernickelt (Z/MN)
Alu-Gussrosette O/ 100 mm

Alle Bestellvarianten finden Sie auf dem ausführlichen Produktblatt



Sonderanfertigung auf Basis
Murau III Decke

Bestellbeispiel:

Sonderanfertigung, Reflektor-O/ 315 mm Stahlblech beschichtet/außen
Tiefschwarz (S/S), innen Reinweiß Muffen Messing poliert, je 500 mm
Pendelrohre O/ 16 mm, Serientype umgekehrt montiert, Zahngelenke
Messing poliert (Z/MP) am Stahlblech-Baldachin montiert

Alle Bestellvarianten finden Sie auf dem ausführlichen Produktblatt



Sonderanfertigung auf Basis
Innsbruck

Bestellbeispiel:

Sonderanfertigung, Reflektor-O/ 320 mm
Stahlblech beschichtet/außen Tiefschwarz (S/S), innen Reinweiß
Standrohr aus Stahlrohr Ø60 mm und Fußplatte Ø450 mm aus Massiv-Eisen,
Leuchten-Gesamthöhe 1200 mm, schwarz-weißes Textil-Kabel (TSW) mit
Zwischenschalter und Schukostecker

Alle Bestellvarianten finden Sie auf dem ausführlichen Produktblatt



Sonderanfertigung auf Basis
Pulkau Kugel Wand

Bestellbeispiel:

Sonderanfertigung
Leuchtenkopf Tiefschwarz (A/S),
Kugelglas opalen, Ø160 mm (max. 60 Watt)
Alu-Wandarm Einrohr geschwungen 370 mm (W1600) mit verlängertem
Verbindungsrohr 600 mm, Alu-Gussrosette Ø100 mm

Alle Bestellvarianten finden Sie auf dem ausführlichen Produktblatt



Sonderanfertigung auf Basis
Retz Kugel Stand

Bestellbeispiel:

Sonderanfertigung, Reflektor-O/ 260 mm Kupfer natur/ohne
Lackierung (K/R)
Kugelglas opalen, Ø180 mm (max. 100 Watt)
Standrohr und Fußplatte aus Massiv-Kupfer natur,
in Fußplatte anschlussfertig verdrahtet
Leuchten-Gesamthöhe 1400 mm

Alle Bestellvarianten finden Sie auf dem ausführlichen Produktblatt



Hof

Bestellbeispiel:

Hof Wand, Reflektorgröße 390 mm x 340 mm
Kupfer natur/ohne Lackierung (K/R), dem natürlichen Altern überlassen
Kupfer-Wandarm Einrohr schräg 350 mm (W235)
Kupfer-Rosette gewellt Ø 110 mm

Die Leuchte in Kupfer, natur ist mit der unlackierten Oberfläche dem natürlichen Altern überlassen. Nach einiger Zeit entwickelt sich eine individuelle Kupferpatina.

Alle Bestellvarianten finden Sie auf dem ausführlichen Produktblatt



Melk Zylinder

Bestellbeispiel:

Leuchtenkopf Stahlblech natur/Klarlack matt (S/M)
 Zylinderglas matt, Ø 110 mm (max. 100 Watt)
 Alu-Gussaufhängung mit vernickelter Kette/schwarzes Textil-Kabel (AGK/TS)

Alle Bestellvarianten finden Sie auf dem ausführlichen Produktblatt

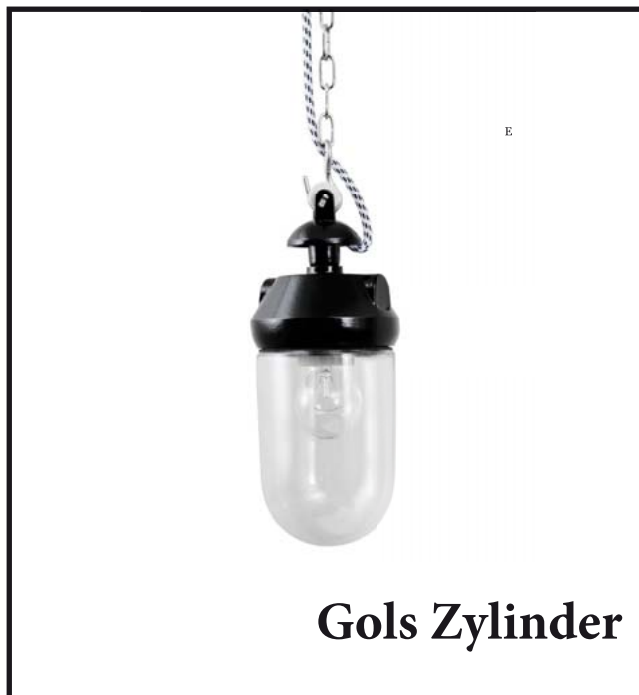

Gols Zylinder

Bestellbeispiel:

Leuchtenkopf Tiefschwarz (A/S)
 Zylinderglas klar, Ø 110 mm (max. 100 Watt)
 Alu-Gussaufhängung mit vernickelter Kette/schwarz-weißes
 Textil-Kabel (AGK/TSW)

Alle Bestellvarianten finden Sie auf dem ausführlichen Produktblatt

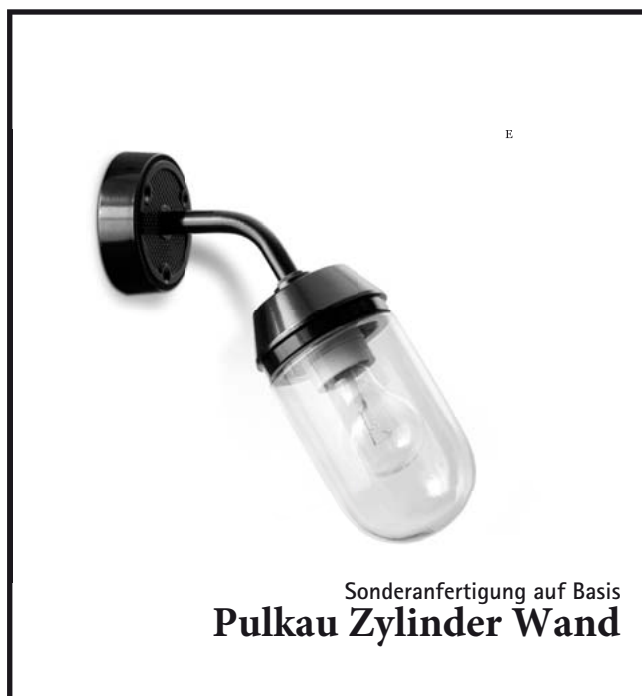

Sonderanfertigung auf Basis
Pulkau Zylinder Wand

Bestellbeispiel:

Sonderanfertigung
 Leuchtenkopf Aluminium Tiefschwarz (A/S) Zylinderglas
 klar, Ø/ 100 mm (max. 60 Watt)
 Alu-Wandarm Einrohr geschwungen 100 mm
 Alu-Gussrosette Ø/ 100 mm

Alle Bestellvarianten finden Sie auf dem ausführlichen Produktblatt

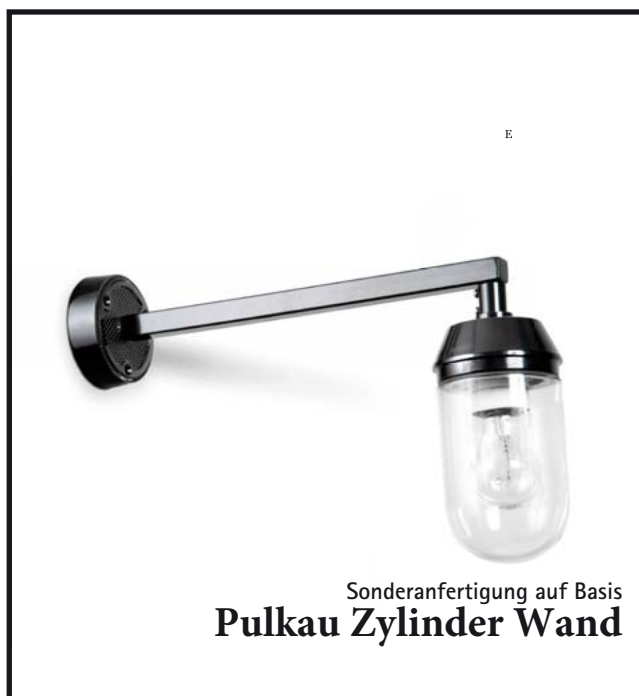

Sonderanfertigung auf Basis
Pulkau Zylinder Wand

Bestellbeispiel:

Sonderanfertigung
 Leuchtenkopf Aluminium Tiefschwarz (A/S) Zylinderglas
 klar, Ø/ 100 mm (max. 60 Watt)
 Alu-Wandarm Einrohr quadratisch 20 x 20 mm
 Alu-Gussrosette Ø/ 100 mm

Alle Bestellvarianten finden Sie auf dem ausführlichen Produktblatt

**Baldachin:**

Baldachin Halbkugel Ø80 mm, Höhe 50 mm
aus veredeltem Stahlblech, tiefgezogen
beschichtet RAL Lichtgrün (S/RAL 6027)
mit Stellring, Durchgang Ø10 mm
vernickeltes Aufhängeröhrchen
vernickelte Kette, weißes Textil-Kabel (TW)

**Kabelbox:**

Sonderanfertigung Alu-Kabelbox mit Messing-vernickelter seitlicher
Kabelverschraubung, vernickelte Kette (ABK)
weißes Textil-Kabel (TW)



E

Klagenfurt**Bestellbeispiel:**

Reflektor-O/ 350 mm
Stahlblech beschichtet/außen RAL-Farben nach Wunsch (S/RAL), innen Reinweiß
Alu-Kabel-Box mit vernickelter Kette/schwarz-weißes Textil-Kabel (ABK/TSW)

RAL-Farbtöne der abgebildeten Leuchten:

Reinweiß, RAL 9010
Pastellblau, RAL 5024
Lichtgrün, RAL 6027
Korallenrot, RAL 3016
Hellelfenbein, RAL 1015

Alle Bestellvarianten finden Sie auf dem ausführlichen Produktblatt

Jeder RAL-Farbtöne möglich



Sievering Stand

Bestellbeispiel:

Reflektor-O/ 350 mm

Aluminium beschichtet/außen RAL moosgrün (A/RAL 6005), innen Reinweiß

Standrohr aus Stahlrohr und Fußplatte aus Massiv-Eisen, spezialgründiert und RAL moosgrün beschichtet (S/RAL 6005)
in Fußplatte anschlussfertig verdrahtet

Leuchten-Gesamthöhe 1400 mm

Alle Bestellvarianten finden Sie auf dem ausführlichen Produktblatt



Retz Zylinder Wand

Bestellbeispiel:

Reflektor-O/ 250 mm

Kupfer natur/Klarlack matt (K/M)

Zylinderglas klar, Ø 100 mm (max. 60 Watt)

Kupfer-Wandarm Einrohr geschwungen 220 mm (W1500)

Alle Bestellvarianten finden Sie auf dem ausführlichen Produktblatt



Pulkau Zylinder Decke

Bestellbeispiel:

Leuchtenkopf Tiefschwarz (A/S)
Zylinderglas klar, Ø/ 100 mm (max. 60
Watt) mit längerem Verbindungsrohr 70
mm

Alle Bestellvarianten finden Sie auf dem ausführlichen Produktblatt



Penzing

Bestellbeispiel:

Reflektor-O/ 150 mm
Stahlblech natur/Klarlack matt (S/M)
Gelenke und Schalter vernickelt
stahlblechverkleideter Gusseisenfuß mit Schalter
schwarz-weißes Textil-Kabel (TSW) 1,5 m
Schukostecker

Alle Bestellvarianten finden Sie auf dem ausführlichen Produktblatt



Sonderanfertigung auf Basis

Penzing Klemm

Bestellbeispiel: Reflektor-0/ 150 mm Stahlblech, außen Tiefschwarz (S/S), innen Reinweiß
Gelenkteile vernickelt, Schwenkarm S-förmig gebogen, Länge 300 mm
Klemme gedrückt aus Messingblech für Klemmung von oben
schwarzes Textil-Kabel (TS) 1,5 m
Schukostecker

Alle Bestellvarianten finden Sie auf dem ausführlichen Produktblatt



Lugeck I

Bestellbeispiel:

Leuchtenlänge 900 mm, 20 Watt Metallteile
Stahlblech natur/Klarlack matt (S/M) 500 mm
Pendelrohrabhangung

Alle Bestellvarianten finden Sie auf dem ausfuhrlichen Produktblatt



Lugeck II

Bestellbeispiel:

Leuchtenlänge 820 mm, 2 x 20 Watt Metallteile
Stahlblech natur/Klarlack matt (S/M) 500 mm
Pendelrohrabhangung

Alle Bestellvarianten finden Sie auf dem ausfuhrlichen Produktblatt



Heiligenstadt

Bestellbeispiel:

Metallteile Messing natur, ohne Lackierung (M/R)
200 mm Pendelrohrabhängung (PR)

Alle Bestellvarianten finden Sie auf dem ausführlichen Produktblatt

**Sievering****Bestellbeispiel:**

Reflektor-O/ 400 mm
 Stahlblech beschichtet/außen Tiefschwarz (S/S), innen Reinweiß
 Schutzkorb Ø400 mm, aus Stahldraht, verzinkt
 Alu-Gussaufhängung mit vernickelter Kette/schwarzes Textil-Kabel (AGK/TS)

Alle Bestellvarianten finden Sie auf dem ausführlichen Produktblatt

**Sievering****Bestellbeispiel:**

Reflektor-O/ 400 mm
 Stahlblech beschichtet/außen Tiefschwarz (S/S), innen Reinweiß
 Alu-Gussaufhängung mit vernickelter Kette/schwarz-weißes
 Textil-Kabel (AGK/TSW)

Alle Bestellvarianten finden Sie auf dem ausführlichen Produktblatt

**Tuchlauben****Bestellbeispiel:**

Reflektor-O/ 350 mm
 Stahlblech beschichtet/außen RAL dahlengelb (S/RAL 1033), innen Reinweiß
 Kabel-Aufhängung/weißes PVC-Kabel (K/PW)

Alle Bestellvarianten finden Sie auf dem ausführlichen Produktblatt



Sonderanfertigung auf Basis

Wels Kugel**Bestellbeispiel:**

Sonderanfertigung, Reflektor-O/ 450 mm
 Stahlblech beschichtet/außen RAL moosgrün (S/RAL 6005), innen Reinweiß
 Zylinderglas matt, Ø110 mm (max. 100 Watt)
 Kabel-Aufhängung/schwarzes PVC-Kabel (K/PS)

Alle Bestellvarianten finden Sie auf dem ausführlichen Produktblatt

**Donaustadt****Bestellbeispiel:**

Reflektor-O/ 240 mm
 Kupfer natur/Klarlack matt (K/M)
 Porzellanfassung/schwarzes Textil-Kabel (P/TS)

Alle Bestellvarianten finden Sie auf dem ausführlichen Produktblatt



Sonderanfertigung auf Basis

Wieden**Bestellbeispiel:**

Sonderanfertigung Reflektor-O/ 300 mm Kupfer natur/
 ohne Lackierung (K/R)
 Stahlseil-Aufhängung/schwarzes PVC-Kabel (S/PS)

Alle Bestellvarianten finden Sie auf dem ausführlichen Produktblatt

**Ottakring****Bestellbeispiel:**

Reflektor-O/ 350 mm
 Kupfer natur/ohne Lackierung (K/R)
 Kupferkette-Aufhängung/schwarzes Textil-Kabel (KK/TS)

Alle Bestellvarianten finden Sie auf dem ausführlichen Produktblatt

**Schwechat****Bestellbeispiel:**

Reflektor-O/ 350 mm
 Kupfer natur/ohne Lackierung (K/R)
 Kupferkette-Aufhängung/schwarzes Textil-Kabel (KK/TS)

Alle Bestellvarianten finden Sie auf dem ausführlichen Produktblatt



Freudenau

Bestellbeispiel:

Reflektor-O/ 500 mm
 Aluminium natur/Klarlack matt (A/M)
 Alu-Kabel-Box mit vernickelter Kette/schwarzes PVC-Kabel (ABK/PS)

Alle Bestellvarianten finden Sie auf dem ausführlichen Produktblatt

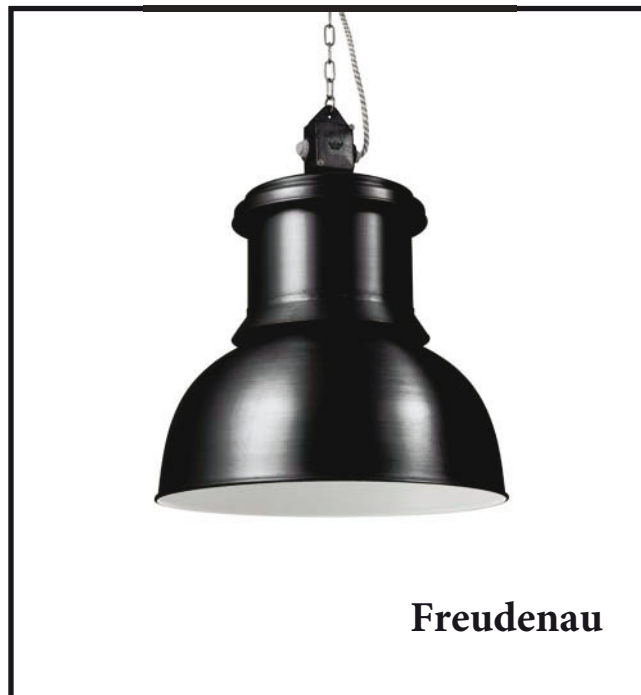

Freudenau

Bestellbeispiel:

Reflektor-O/ 400 mm
 Stahlblech beschichtet/außen Tiefschwarz (S/S), innen Reinweiß
 Alu-Kabel-Box mit vernickelter Kette/schwarz-weißes Textil-Kabel (ABK/TSW)

Alle Bestellvarianten finden Sie auf dem ausführlichen Produktblatt



Klagenfurt Typ 2

Bestellbeispiel:

Reflektor-O/ 300 mm
 Aluminium natur/Klarlack matt (A/M)
 vernickelte Kette-Aufhängung/schwarzes Textil-Kabel (VK/TS)

Alle Bestellvarianten finden Sie auf dem ausführlichen Produktblatt



Klagenfurt

Bestellbeispiel:

Reflektor-O/ 350 mm
 Stahlblech beschichtet/außen Reinweiß (S/W), innen Reinweiß
 Alu-Kabel-Box mit vernickelter Kette/schwarz-weißes Textil-Kabel (ABK/TSW)

Alle Bestellvarianten finden Sie auf dem ausführlichen Produktblatt



Wels Kugel Stand

Bestellbeispiel:

Reflektor-O/ 350 mm
 Aluminium beschichtet/außen RAL weißalu (A/RAL 9006), innen RAL weißalu
 Kugelglas opalen (max. 100 Watt)
 Standrohr aus Stahlrohr und Fußplatte aus Massiv-Eisen,
 spezialgrundiert und RAL weißaluminium beschichtet (S/RAL 9006)
 in Fußplatte anschlussfertig verdrahtet
 Leuchten-Gesamthöhe 1400 mm
 Alle Bestellvarianten finden Sie auf dem ausführlichen Produktblatt



Retz Zylinder Stand

Bestellbeispiel:

Reflektor-O/ 350 mm
 Aluminium beschichtet/außen Reinweiß (A/W), innen Reinweiß
 Zylinderglas klar (max. 100 Watt)
 Standrohr aus Stahlrohr und Fußplatte aus Massiv-Eisen,
 spezialgrundiert und RAL reinweiß beschichtet (S/RAL 9010)
 in Fußplatte anschlussfertig verdrahtet
 Leuchten-Gesamthöhe 1400 mm
 Alle Bestellvarianten finden Sie auf dem ausführlichen Produktblatt



Sievering Stand

Bestellbeispiel:

Reflektor-O/ 350 mm
 Stahlblech natur/Klarlack matt (S/M)
 Standrohr aus Stahlrohr und Fußplatte aus Massiv-Eisen,
 Klarlack matt beschichtet (S/M)
 in Fußplatte anschlussfertig verdrahtet
 Leuchten-Gesamthöhe 1400 mm

Alle Bestellvarianten finden Sie auf dem ausführlichen Produktblatt



Währing

Bestellbeispiel:

Reflektor-O/ 240 mm
 Kupfer natur/Klarlack matt (K/M)
 Kabel-Aufhängung/schwarzes Textil-Kabel (K/TS)

Alle Bestellvarianten finden Sie auf dem ausführlichen Produktblatt



Salzburg Kugel

Bestellbeispiel:

Reflektor-O/ 350 mm
 Kupfer natur/Klarlack glänzend (K/G)
 Kugelglas opalen, Ø180 mm (max. 100 Watt)
 Kabel-Aufhängung/schwarzes Textil-Kabel (K/TS)

Alle Bestellvarianten finden Sie auf dem ausführlichen Produktblatt



Salzburg Zylinder

Bestellbeispiel:

Reflektor-O/ 350 mm
 Kupfer natur/Klarlack glänzend (K/G)
 Zylinderglas matt, Ø110 mm (max. 100 Watt)
 Kabel-Aufhängung/schwarzes Textil-Kabel (K/TS)

Alle Bestellvarianten finden Sie auf dem ausführlichen Produktblatt



Sonderanfertigung auf Basis **Murau Aufbau**

Bestellbeispiel:

Sonderanfertigung
 Reflektor-Ø315 mm
 Stahlblech beschichtet/außen Tiefschwarz (S/S), innen Reinweiß
 Alu-Gussaufhängung mit vernickelter Kette/schwarzes Textil-Kabel (AGK/TS)

Alle Bestellvarianten finden Sie auf dem ausführlichen Produktblatt



Passau

Bestellbeispiel:

Reflektor-O/ 450 mm
 Stahlblech beschichtet/außen Reinweiß (S/W), innen Reinweiß
 Alu-Gussaufhängung mit vernickelter Kette/schwarz-weißes
 Textil-Kabel (AGK/TSW)

Alle Bestellvarianten finden Sie auf dem ausführlichen Produktblatt



Josefstadt

Bestellbeispiel:

Reflektor-O/ 300 mm
 Stahlblech beschichtet/außen Hellrosa (S/RAL 3015), innen Reinweiß
 Kabel-Aufhängung/schwarzes Textil-Kabel (K/TS)

Alle Bestellvarianten finden Sie auf dem ausführlichen Produktblatt



Krems Zylinder II

Bestellbeispiel:

Beflektoren-O/ 350 mm
 Stahlblech beschichtet/außen Tiefschwarz (S/S), innen Reinweiß
 Zylindergläser klar, Ø 110 mm (max. 100 Watt)
 mit Pendelarm geschwungen (PBO800), 1000 mm Pendelrohrabhängung

Alle Bestellvarianten finden Sie auf dem ausführlichen Produktblatt



Klagenfurt

Bestellbeispiel:

Reflektor-O/ 350 mm
 Stahlblech beschichtet/außen Pastellblau (S/RAL 5024), innen Reinweiß
 Alu-Kabel-Box mit vernickelter Kette/schwarz-weißes Textil-Kabel (ABK/TSW)

Alle Bestellvarianten finden Sie auf dem ausführlichen Produktblatt



Passau

Bestellbeispiel:

Reflektor-O/ 450 mm
 Stahlblech beschichtet/außen Lichtgrün (S/RAL 6027), innen Reinweiß
 Alu-Gussaufhängung mit vernickelter Kette/schwarz-weißes
 Textil-Kabel (AGK/TSW)

Alle Bestellvarianten finden Sie auf dem ausführlichen Produktblatt



Lugeck I

Bestellbeispiel:

Leuchtengänge 900 mm, 20 Watt
 Metallteile Stahlblech beschichtet Perlenzian (S/RAL 5025)
 Zahngelenk Messing vernickelt (Z/MN)
 500 mm Pendelrohrabhängung

Alle Bestellvarianten finden Sie auf dem ausführlichen Produktblatt

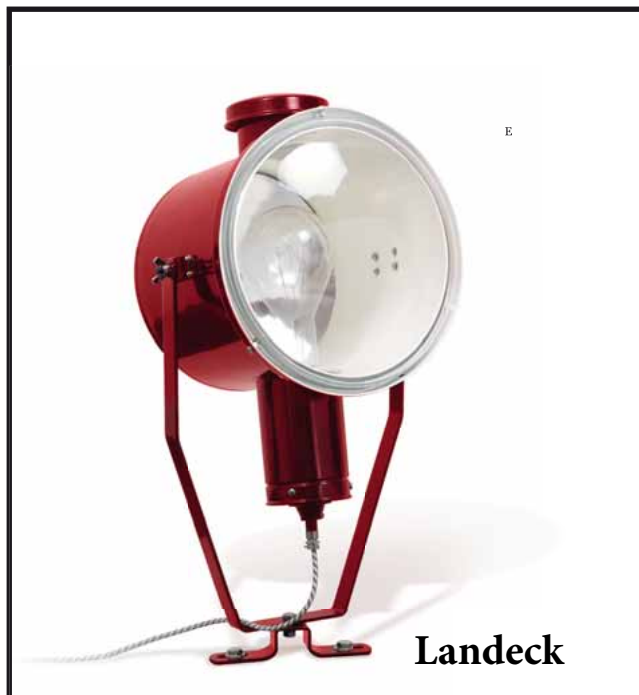

Landeck

Bestellbeispiel:

Reflektor-O/ 370 mm
 Stahlblech beschichtet/außen Signalrot (S/RAL 3001), innen Reinweiß
 mit Spiegel-Reflektor
 schwarz-weißes Textil-Kabel (TSW) 1,5 m
 Schukostecker

Alle Bestellvarianten finden Sie auf dem ausführlichen Produktblatt



Hietzing

Bestellbeispiel:

Reflektor-O/ 235 mm
 Stahlblech beschichtet/außen Rehbraun (S/RAL 8007), innen Reinweiß
 Gelenke und Schalter vernickelt
 stahlblechverkleideter Gusseisenfuß mit Schalter
 schwarz-weißes Textil-Kabel (TSW) 1,5 m
 Schukostecker

Alle Bestellvarianten finden Sie auf dem ausführlichen Produktblatt

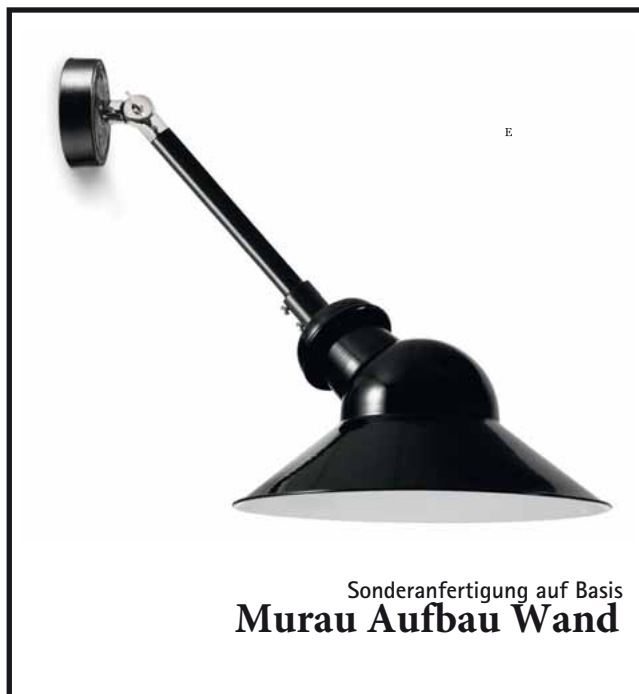

Sonderanfertigung auf Basis

Murau Aufbau Wand

Bestellbeispiel:

Wand plus Gelenk, Reflektor-O/ 315 mm
 Stahlblech beschichtet/außen Tiefschwarz (S/S), innen Reinweiß
 mit Muffe und Verbindungsrohr 250 mm
 Zahngelenk Messing vernickelt (Z/MN)
 Alu-Gussrosette Ø 100 mm

Alle Bestellvarianten finden Sie auf dem ausführlichen Produktblatt



Sonderanfertigung auf Basis

Sievering Schutzglas

Bestellbeispiel:

Sonderanfertigung Reflektor-O/ 315 mm Stahlblech,
außen Tiefschwarz (S/S), innen Reinweiß
Glas-Ø300 mm, Schutzkorb Ø350 mm, aus Stahldraht, verzinkt
Alu-Gussaufhängung mit vernickelter Kette/schwarzes Textil-Kabel (AGK/TS)

Alle Bestellvarianten finden Sie auf dem ausführlichen Produktblatt